

FOREWORD

- Thank you very much for purchasing our tractor which will give you many years of reliable service.
- The introduction in this manual sets out the correct manner of operating, maintaining and checking the tractor to ensure long-term durability.
- Please ensure correct operation of the tractor as incorrect can cause substantial mechanical damage as well as cause accidents with the associated injuries.
- Please note that in some cases differences can exist between this manual and your tractor due to the manufacture's policy of constant product improvement.
- In the event that you encounter a problem not covered by this manual, please contact your nearest dealer who will assist you in resolving your problem.







TYM

WARNING SIGNS

WARNING SIGNS IN THIS MANUAL

The following warning signs in this manual draw additional attention to items of importance for the safe and correct operation of the tractor.

SIGNS	MEANING OF THE SIGN
 DANGER	This indicates that a condition may result in harm, serious injury or death to you or other persons if the warning is not heeded. Follow the advice provided with the warning signs.
 WARNING	Hazard or unsafe practice that can lead to severe injury or death.
 CAUTION	Hazard or unsafe practice that can lead in injury or death.
 IMPORTANT	Instructions for the correct operation of the machine which, if followed, will ensure that it performs at its best.

All information, illustrations and specifications in this manual are based on latest information available at the time of publication. The right is reserved to make change at any time without a notice.

GENERAL INFORMATION

A

SAFETY PRECAUTIONS

B

TRACTOR INSTRUMENTS

C

OPERATION

D

MAINTENANCE

E

TROUBLESHOOTING

F

STANDARD FOR FARMWORK

G

APPENDIX

H

INDEX

I

TABLE OF CONTENTS

GENERAL INFORMATION **A**

1. EXTERIOR VIEW A-2
2. TRACTOR IDENTIFICATION A-5
3. ABOUT THIS MANUAL A-6
4. INTRODUCTION & DESCRIPTION A-7
5. OWNER ASSISTANCE A-9
6. ROPS (ROLL OVER PROTECTIVE STRUCTURES) A-10
7. SEAT ADJUSTMENT A-12

TRACTOR INSTRUMENTS **C**

1. SWITCHES C-2
2. MONITOR PANEL & GAUGES C-7
3. CONTROL INSTRUMENTS C-11
4. THREE POINT LINKAGE C-17
5. CABIN C-20

MAINTENANCE **E**

1. MAINTENANCE SCHEDULE E-2
2. OPENING COVERS E-4
3. CHECKS & SERVICING EACH PART E-5
4. GREASING EACH PART E-18
5. STORING THE TRACTOR E-19

SAFETY PRECAUTIONS **B**

1. SAFETY INSTRUCTIONS B-2
2. SAFE OPERATION OF TRACTOR B-15
3. DOs & DON'Ts B-22
4. SAFETY DECALS B-24
5. UNIVERSAL SYMBOLS B-29

OPERATION **D**

1. START & STOP OF ENGINE D-2
2. OPERATING TRACTOR D-4
3. OPERATION OF PTO D-7
4. OPERATION OF DPF D-9
5. IMPLEMENTS D-10
6. TOWING THE TRACTOR D-11
7. CHECKS DURING DRIVING D-13
8. WORK PROCEDURES D-15
9. OPERATION TIPS D-21

TROUBLESHOOTING **F**

1. ENGINE F-2
2. BRAKE F-5
3. STEERING WHEEL & HYDRAULIC SYSTEM F-6
4. ELECTRIC INSTRUMENTS F-7

STANDARD FOR FARMWORK **G**

1. STANDARD FOR FARMWORK G - 2

INDEX **I**

1. INDEX I - 2

APPENDIX **H**

1. SPECIFICATION H - 2
2. TRAVELLING SPEED H - 4
3. FUSE BOX H - 4
4. MASS AND TIRE H - 5
5. DIESEL FUEL H - 6
6. ENGINE COOLANT H - 10
7. NOISE LEVEL H - 13
8. VIBRATION REFERRED TO THE
OPERATOR POSITION H - 14

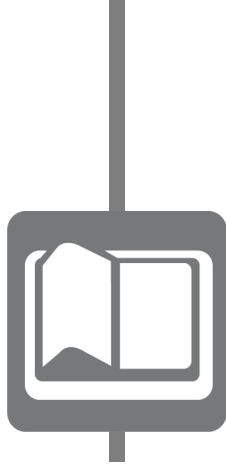

GENERAL INFORMATION

1. EXTERIOR VIEW A – 2
2. TRACTOR IDENTIFICATION A – 5
3. ABOUT THIS MANUAL A – 6
4. INTRODUCTION & DESCRIPTION A – 7
5. OWNER ASSISTANCE A – 9
6. ROPS (Roll Over Protective Structures) A – 10
7. SEAT ADJUSTMENT A – 12



GENERAL INFORMATION

1. EXTERIOR VIEW

► RIGHT SIDE OF THE TRACTOR

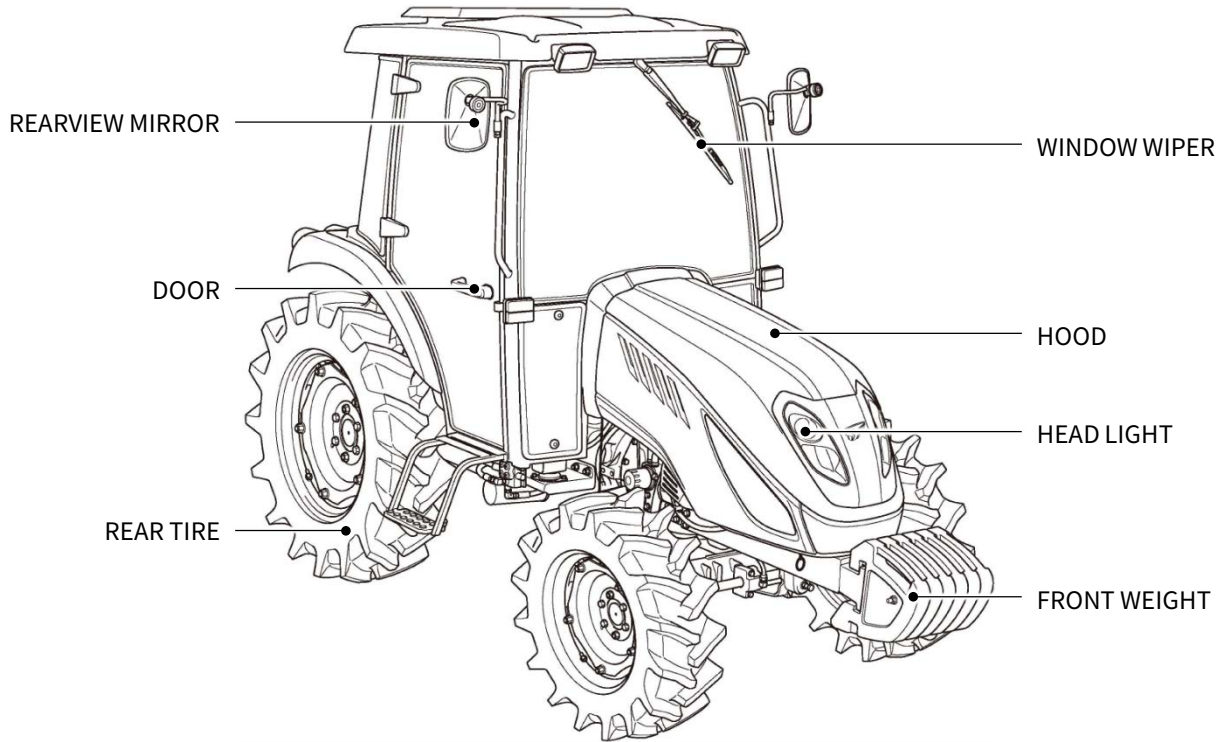



▶ LEFT SIDE OF THE TRACTOR

A





► BACK SIDE OF THE TRACTOR

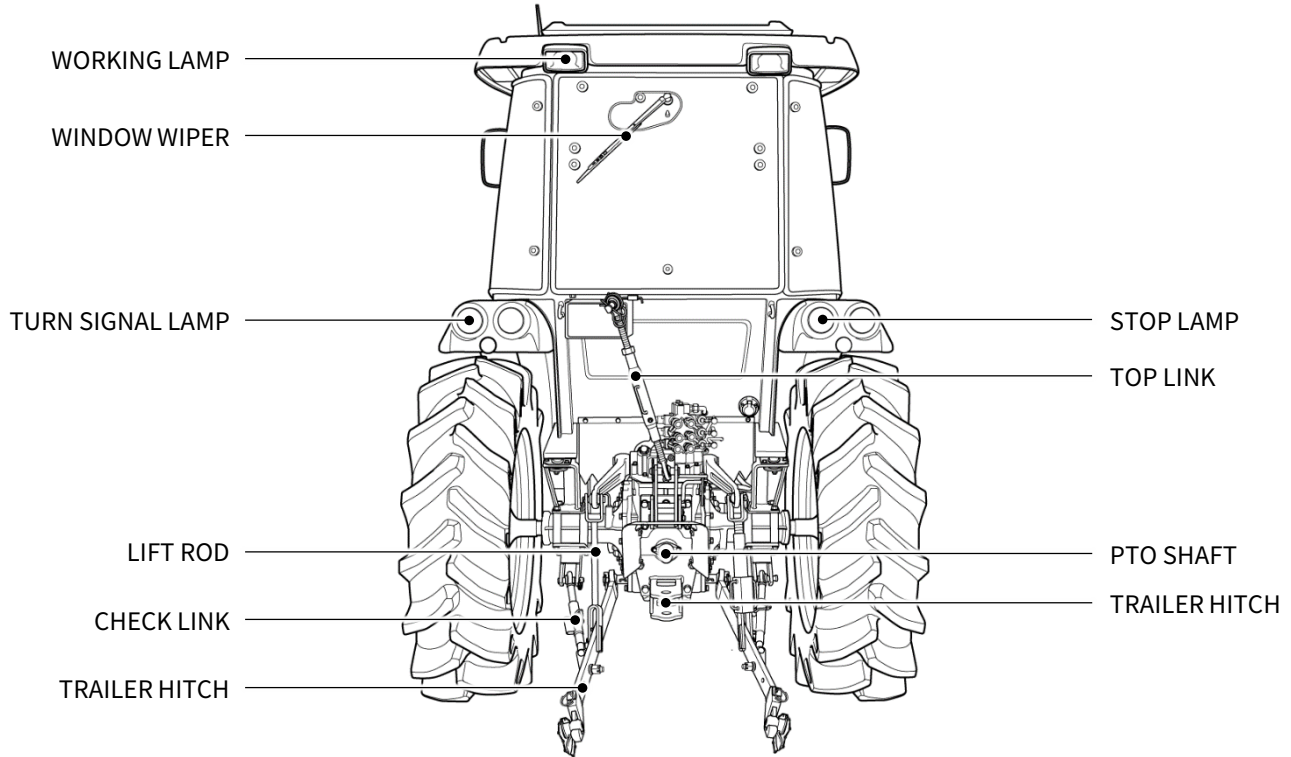

2. TRACTOR IDENTIFICATION

▶ TYPE OR NUMBER OF ENGINE & CHASSIS

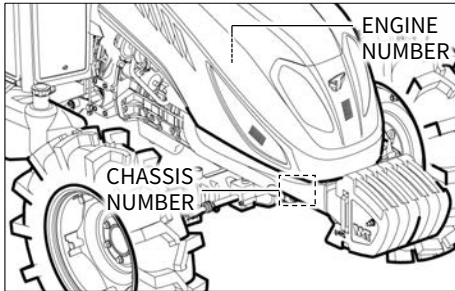

The engine and chassis number are stamped as shown in the drawing above.

▶ WARRANTY OF THE PRODUCT

The manufacturer warrants this product and full details of the warranty are provided on a separate warranty schedule.

▶ SERVICE & PARTS

• SERVICE

Service is available from any TYM dealer in the country.

• PARTS

To obtain spare parts please contact your nearest dealer and give him the details listed below.

- Tractor model
- Tractor serial number
- Tractor engine number
- Part number and description
- Quantity required

A



3. ABOUT THIS MANUAL

This manual has been prepared to assist you in following/adopting the correct procedure for running-in operation and maintenance of your new TYM CO., LTD tractor.

Your tractor has been designed and built to give maximum performance, with good fuel economy and ease of operation under a wide variety of operating conditions.

Prior to delivery, the tractor was carefully inspected, both at the factory and by your TYM Dealer/Distributor, to ensure that it reaches you in optimum conditions.

To maintain this condition and ensure trouble free performance, it is important that the routine services, as specified in this manual, are carried out at the recommended intervals.

Read this manual carefully and keep it in a convenient place for future reference.

If at any time you require advice concerning your tractor, do not hesitate to contact your authorized TYM dealer / distributor.

He has trained personnel, genuine parts and necessary equipment to undertake all your service requirements.

Manufacturer's policy is one of continuous improvement, and the right to change prices, specifications or equipment at any time without notice is reserved.

All data given in this book is subject to production variations.

Dimensions & weight are approximate only and the illustrations do not necessarily show tractors in standard condition.

For exact information about any particular tractor, please consult your TYM dealer / distributor.

4. INTRODUCTION & DESCRIPTION

► INTRODUCTION OF A TRACTOR

The word, 'tractor' has been derived from 'traction' which means pulling. A tractor is required to pull or haul an equipment, implement or trolley which are coupled to the tractor body through suitable linkage.

A tractor can also be used as a prime mover as it has a power outlet source which is also called Power Take or PTO shaft.

In this book the operating, maintenance and storage instructions for all models of TYM diesel tractors has been compiled. This material has been prepared in detail to help you in the better understanding of maintenance and efficient operation of the machine.

If you need any information not given in this manual, or require the services of a trained mechanic, please get in touch with the TYM dealer / distributor in your locality.

Dealer / distributors are kept informed of the latest methods of servicing tractors.

They stock genuine spare parts and are backed by the company's full support.

Through this manual, the use of the terms LEFT, RIGHT, FRONT and REAR must be understood, to avoid any confusion when following the introductions.

The LEFT and RIGHT means left and right sides of the tractor when facing forward in the driver's seat, reference to the FRONT indicates the radiator end of the tractor, while the REAR, indicates the drawbar end.

When spare parts are required, always specify the tractor and engine serial number when ordering these parts. This will facilitate faster delivery and help ensure that the correct parts for your particular tractor is received.

The tractor serial number is punched on a plate attached to the left hand side of the engine body.

For easy reference, we suggest you to write the number in the space provided in the owner's personal data.

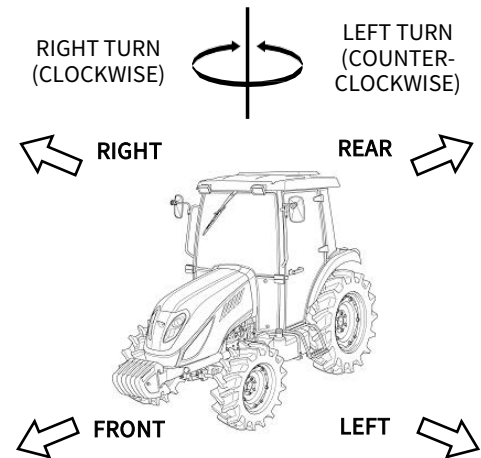



► DESCRIPTION

• GENERAL CONSTRUCTION

The transmission case, engine and front axle support are bolted together to form a rigid unit.

• FRONT AXLE & WHEEL

The 4WD front axle is a center-pivot, reverse eliot type.

The front wheel drive mechanism is incorporated as a part of the axle. The front wheel drive power is taken off the rear transmission and transmitted to the differential in the front axle where the power is divided into right and left and to the respective final cases.

In the final cases, the transmitted revolution is reduced by the level gears to drive the front wheel.

The 4WD mechanism with level gears provides wider steering and greater durability.

• ENGINE

The tractors are fitted with fuel efficient engines with 4 cylinders of designed by YANMAR engines.

• TRANSMISSION

The Tractor is fitted with servo controlled HST with three ranges and can be selected range by lever. The tractor has two pedals for speed and forward/reverse control. Tractor with Independent Power Take Off is fitted with electro – hydraulic clutch assy.

• BRAKES

TYM tractors are provided with independent disc brakes operated by two brake rods' movement. Use parking brake lever in case of parking the tractor.

• REAR AXLE & WHEELS

This is mounted on ball bearings and is enclosed in removable housing which are bolted to the transmission case. The rim & disc fitted with rear tires are bolted to the outer flange of rear axle.

• HYDRAULIC SYSTEM & LINKAGES

TYM tractors are fitted with live independent, very touch of hydraulic system.

Three point linkages can be used for category 1 type of implements.

• STEERING

It consists of hydrostatic power steering system, which has a hydraulic cylinder and single type hydraulic pump.

5. OWNER ASSISTANCE

• **ELECTRICAL SYSTEM**

A 12 volt lead acid propylene battery is used to activate the engine through the starter motor and the electrical system comprising horn, head lamp. Side indicator lamps, plough lamp, brake light, gauge lamp, hazard lamp. Generator or alternator, fuse box also from part of the electrical system.

 **WARNING**

- When operating the tractor at high speed, do not attempt to make sharp turns by using the brakes. This may result in overturning of the tractor causing serious injury or death.

We at TYM CO., LTD and your TYM dealer / distributor wants you to be completely satisfied with your investment.

Normally any problems with your equipment will be handled by your dealer / distributor’s service departments, however, misunderstanding can occur. If you feel that your problem has not been handled to your satisfaction, we suggest the following.

Contact the owner or general manager of the dealership, explain the problem, and request assistance. When additional assistance is needed, your dealer / distributor has direct access to your office.

If you cannot obtain satisfaction by doing this, contact the TYM CO., LTD. office and provide them with;

- Your name, address and telephone number
- Model and tractor serial number
- Dealer / distributor name & address
- Machine purchase date and Hours used
- Nature of problem

Before contacting TYM CO., LTD office, be aware that your problem will likely to be resolved in the dealership using the dealer’s / distributor’s facilities, equipment and personnel. So it is important that your initial contact be with the dealer / distributor.

A



6. ROPS (Roll Over Protective Structure)

► ROPS

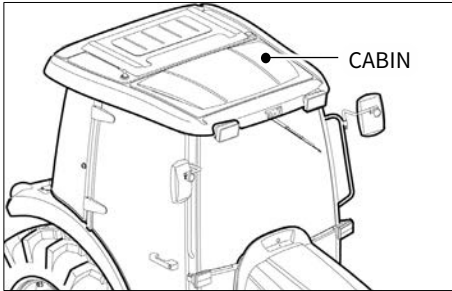

TYM tractors are equipped with a frame for the protection of operators. In the case of cab tractors the frame is incorporated in the cab structure. The objective of the frame or cab structure is to protect the operator in the event of a roll over and they are designed to support the entire weight of the tractor in that event.

Each TYM ROPS frame or cab structure is designed and has been tested to meet industry and or government standards. Included in these tests were all mounting bases and bolts or other fasteners.

On some models the ROPS frame has a fold down feature, which can be used to enter low buildings etc.

Take care when lowering the upper section of the ROPS frame and take extreme care while driving the tractor with the ROPS frame lowered.

Do not wear the seat belt with the ROPS lowered and please remember that the fold down facility is for special circumstances only and must not be lowered for general use.

DANGER

- For ROPS frames to be effective and protect the operator, the seat belt provided must be worn in order to keep operators within the ROPS protected area in the event of a roll over. Failure to use the seat belt can still cause serious injury or death.

► USE OF TRACTOR WITH ROPS LOWERED CAN CAUSE FATAL INJURIES

As the ROPS frame or cab together with the seat belt was designed to meet certain standards, they must be maintained in good order and condition. To achieve this objective, both the structure and the seat belt should be inspected on a regular basis. (Every time the tractor is serviced)

In the event that the seat belt is damaged or frayed, it should be replaced and in the event that the ROPS frame or any part of the mounting structure is damaged or cracked, the faulty component must be replaced with a new unit.

Such a unit must meet all of the test criteria of the original unit. Fitment of an inferior item or items affects the certification of the entire ROPS structure and the effectiveness of the structure in the event of an accident. Drilling or welding of the ROPS is forbidden.

► **DAMAGE OF ROPS**

If the tractor has rolled over or the ROPS has damaged (such as striking an overhead object during transport), it must be replaced to provide the original protection.

After an accident, check for damages to

- **ROPS**
- **SEAT**
- **SEAT BELT & SEAT MOUNTINGS**

Before you operate a tractor, replace all damaged parts.

 **WARNING**

- Do not weld, drill or straighten the ROPS.

 **WARNING**

- Always wear your seat belt if the tractor is equipped with ROPS.

 **WARNING**

- If the ROPS is removed or replaced, make certain that the proper hardware is used to replace the ROPS and the recommended torque values are applied to the attaching bolts.

 **WARNING**

- Never attach chains, ropes to the ROPS for pulling purposes. This will cause the tractor to tip backwards. Always pull from the tractor drawbar.
- Be careful when driving through door opening or under low overhead objects. Make sure there is sufficient overhead clearance for the ROPS fatal injuries.

CABIN TYPE



A

ROPS TYPE





7. SEAT ADJUSTMENT

▶ SEAT SLIDING



To select seat position, move adjusting lever and slide seat closer to or away from dash panel and controls.

DANGER

- Check whether the seat properly locked in its position before driving the tractor.
- Always use the seat belt when the ROPS is installed.
- Do not use the seat belt if a foldable ROPS is down or there is no ROPS. Check the seat belt regularly and replace if frayed or damaged.

Before operating a tractor it is important to adjust the seat to the most comfortable position & check whether it is properly locked in its position.

IMPORTANT

- Do not use solvents to clean the seat. Use warm water with a little detergent added.

WARNING

- Do not put a hand between the seat and the slides when adjusting the seat position. You can get injured unexpectedly.

▶ SEAT BACK ANGLE, CUSHION STRENGTH ADJUSTMENT

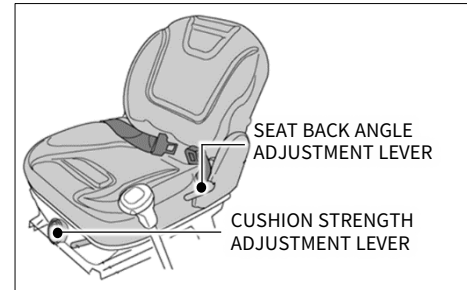

● SEAT BACK ANGLE ADJUSTMENT

The seat can be fold down or up using seat back angle adjustment lever.

● CUSHION STRENGTH ADJUSTMENT

The seat cushion can be adjusted according to the weight of the driver.

Turning the cushion adjustment lever counterclockwise to the 50kg position makes the cushion lighter, and turning the lever clockwise to the 130kg position makes the cushion heavier.

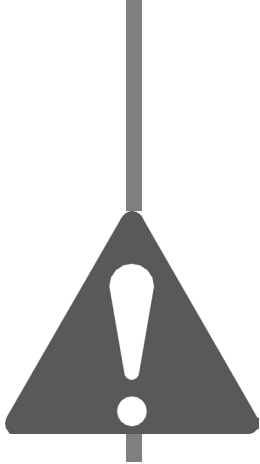

SAFETY PRECATIONS

- 1. SAFETY INSTRUCTIONS B - 2
- 2. SAFE OPERATION OF TRACTOR B - 15
- 3. DOs & DON'Ts B - 22
- 4. SAFETY DECALS B - 24
- 5. UNIVERSAL SYMBOLS B - 29

! SAFETY PRECAUTIONS

1. SAFETY INSTRUCTIONS

► ENSURE SAFETY INFORMATION



This symbol means

‘Attention! Your safety is involved.’

The message that follows the symbol contains important information about safety.

Carefully read the message.

► SIGNAL SIGNS



The signal signs

‘DANGER, WARNING or CAUTION’

are used with safety alert symbol.

DANGER identifies the most serious hazards.

Safety symbols with signal signs ‘DANGER or WARNING’ are typically near specific hazards.

General precautions are listed on CAUTION safety signs.

► READ SAFETY INSTRUCTION

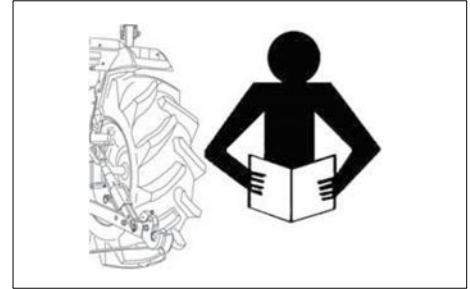

Carefully read all safety instructions given in this manual for your safety. Tempering with any of the safety devices can cause serious injuries or death.

Keep all safety signs in good condition. Replace missing or damaged safety signs.

Keep your tractor in proper condition and do not allow any unauthorized modifications to be carried out on the tractor, which may impair the function / safety and affect tractor life.



► PROTECT CHILDREN



Keep children and others away from the tractor while operating.

Before you reverse

- Look behind tractor for children.
- Do not let children to ride on tractor or any implement.

► USE OF ROPS AND SEAT BELT



The Roll Over Protective Structure (ROPS) has been certified to industry and / or government standard.

Any damage or alternation to the ROPS, mounting hardware or seat belt voids the certification and will reduce or eliminate protection for the operator in the event of a roll-over.

The ROPS, mounting hardware and seat belt should be checked after the first 100 hours of use and every 500 hours thereafter for any evidence of damage, wear or cracks.

In the event of damage or alternation, the ROPS must be replaced prior to further operation of the tractor.

The seat belt must be worn during machine operation when the machine is equipped with a certified ROPS.

Failure to do so will reduce or eliminate protection for the operator in the event of a roll-over.

B

SAFETY PRECAUTIONS

► PRECAUTION TO AVOID TIPPING

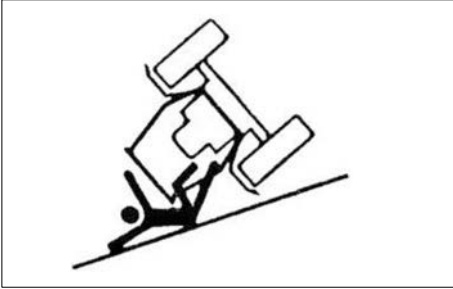

Do not drive where the tractor could slip or tip.

Stay alert for holes and rocks in the terrain and other hidden hazards.

Slow down before you make a sharp turn.

Driving forward out of a ditch or mired condition could cause tractor to tip over backward.

Back out of these situations if possible.

► PARK TRACTOR SAFELY

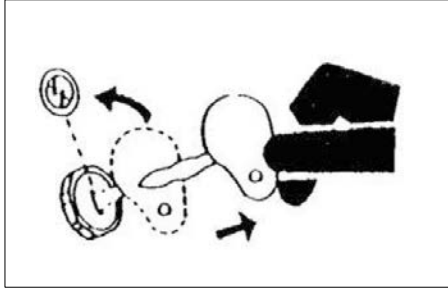

Before working on the tractor:

- Lower all equipment to the ground.
- Stop the engine and remove the key.

► KEEP RIDERS OFF TRACTOR



Do not allow riders on the tractor.

Riders on tractor are subject to injury such as being stuck by foreign objects and being thrown off of the tractor.



▶ **HANDLE FUEL SAFELY AVOIDING FIRES**



Handle fuel with care.
It is highly flammable.

Do not refuel the tractor while smoking or near open flame or sparks.

Always stop engine before refueling tractor.

Always keep your tractor clean of accumulated grease and debris.
Always clean up spilled fuel.

▶ **STAY CLEAR OF ROTATING SHAFTS**



Entanglement in rotating shaft can cause serious injury or death.

Keep PTO shield in place at all the time.

Wear fitting clothing.

Stop the engine and be sure PTO drive is stopped before making adjustments, connections or cleaning out of PTO driven equipment.

▶ **ALWAYS USE SAFETY LIGHTS AND DEVICES**

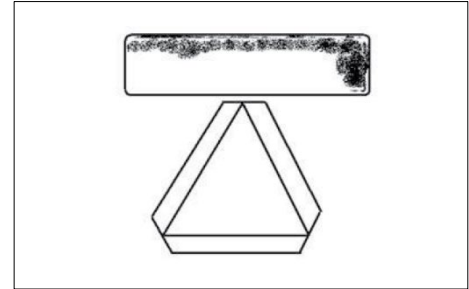

Use of hazard warning lights and turn signals are recommended when towing equipment on public roads unless prohibited by state or local regulations.

Use slow moving vehicle (SMV) sign when driving on public road during both day & night time unless prohibited by law.

SAFETY PRECAUTIONS

► PRACTICE SAFE MAINTENANCE



Understand service procedure before doing work.

- Keep the surrounding area of the tractor clean and dry.
- Do not attempt to service tractor when it is in motion.
- Keep body and equipment to the ground.
- Stop the engine.
- Remove the key.
- Allow tractor to cool before any work repair is caused on it.
- Securely support any tractor elements that must be raised for service work.

- Keep all parts in good condition and properly installed.
- Replace worn or broken parts.
- Replace damaged / missing decals.
- Remove any build-up of grease or oil from the tractor.
- Disconnect battery ground cable ⊖ before making adjustments on electrical systems or welding on tractor.

► AVOID HIGH PRESSURE FLUIDS



Escaping fluid under high pressure can penetrate the skin causing serious injury. Keep hands and body away from pin holes and nozzle which eject fluids under high pressure.

If any fluid is injected into the skin, consult your doctor immediately.

**▶ PREVENT BATTERY EXPLOSION**

Keep sparks, lighted matches and open flame away from the top of battery. Battery gas can explode.

Never check battery charge by placing a metal object across the poles.

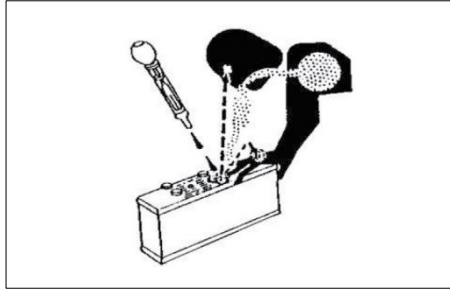
▶ PREVENT ACID BURNS

Sulfuric acid in battery electrolyte is poisonous. It is strong enough to burn skin, cause holes in clothing and cause blindness if found entry into eyes.

For adequate safety always:

- Fill batteries in a well-ventilated area.
- Wear eye protection and acid proof hand gloves.
- Avoid breathing direct fumes when electrolyte is added.
- Do not add water to electrolyte as it may splash off causing severe burns.

If you spill acid on yourself:

1. Flush your skin or eyes with water for 10 ~ 15 minutes.
2. Get medical attention immediately.

SAFETY PRECAUTIONS

▶ BATTERY DISCONNECTION

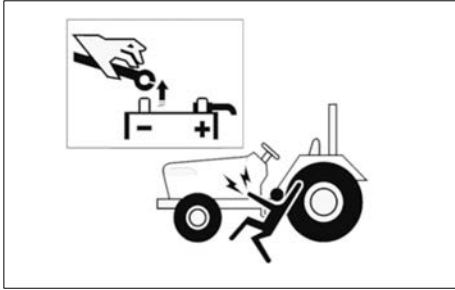

When working with your tractor electrical components, you must first disconnect the battery cables.

To ensure that there are no accidents from sparks, you must first disconnect the negative battery cable.

▶ SERVICE TRACTOR SAFELY

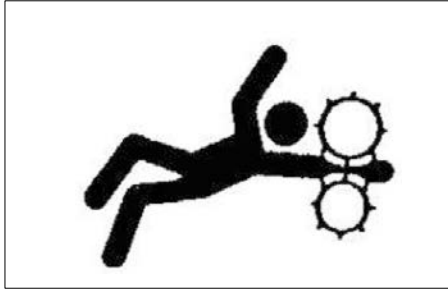

Do not wear a necktie, scarf or loose clothing when you work near moving parts. If these items were to get caught, severe injury could result.

Remove rings and other jewelry to prevent electrical shorts and entanglement in moving parts.

▶ WORK IN VENTILATED AREA

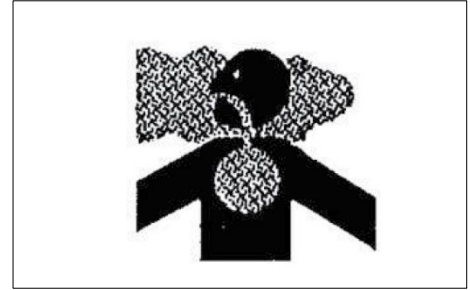

Do not start the tractor in an enclosed building unless the doors & windows are open for proper ventilation as tractor fumes can cause sickness or death.

If it is necessary to run an engine in an enclosed area remove the exhaust fumes by connecting exhaust pipe extension.



▶ TRACTOR RUNAWAY

Engine start with transmission engaged can cause tractor to runaway resulting serious injury to the people standing nearby the tractor.

For additional safety keep the pull to stop knob (Fuel shut off control) in fully pulled out position.

Transmission in neutral position, foot brake engaged and PTO lever in disengaged position while attending to Safety Starter Switch or any other work on tractor.

▶ SAFETY START

Safety Starter switch for starting is provided on transmission main or sub shift lever and in PTO shift lever.

The tractor can be started only if main or sub shift lever is in neutral position.

CAUTION

- Safety Starter Switch is to be replaced after every 2,000 hours/4 years, whichever is earlier.

▶ EMERGENCY EXITS

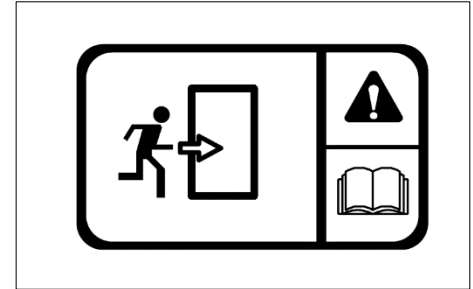

If exit from the cab side doors is blocked (following an accident or vehicle overturn) the alternative safety exits are indicated by decals.

The possible safety exits are:

- Rear window hatch (All tractors)
- Front window (for versions with openable front window).

SAFETY PRECAUTIONS

► SAFETY PRECAUTIONS WHEN USING LOADER

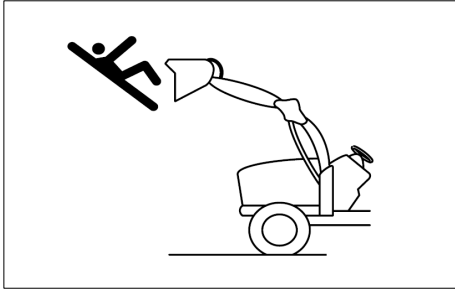

Never let anyone get in the loader and use the loader as a workbench. Otherwise, it may lead to a fatal injury or even death.

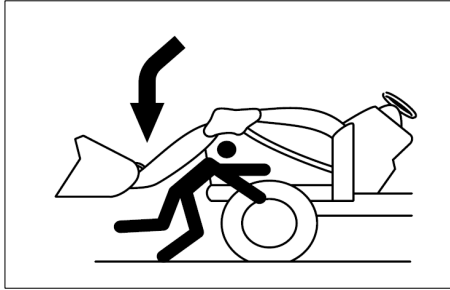

Do not stand under the lifted loader or get close to it. Also, lower the loader arm onto the ground before leaving the tractor. Otherwise, it may lead to a fatal injury or even death.

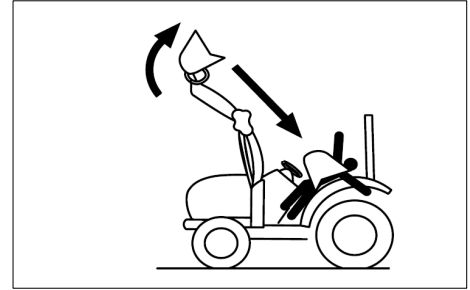

When attaching or detaching the loader, fix all parts which are connected to the bucket and boom. The bucket or boom can be accidentally dropped down, leading to an injury or even death.



Be careful of objects falling from loader.

IMPORTANT

- ROPS (Roll Over Protective Structure), sun canopy or cabin are not a FOPS (Falling Object Protective Structure). It never can protect the riders against falling objects. Avoid driving the vehicle into a dangerous area such as falling rocks zone.

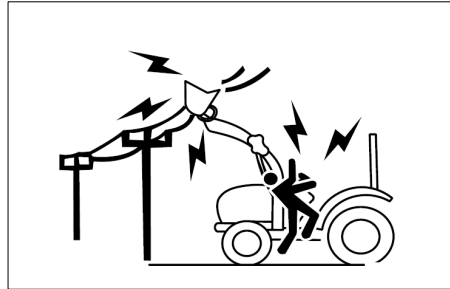

Do not allow loader arms or attachment to contact electrical power lines. Electrocutation will cause serious injury or death.

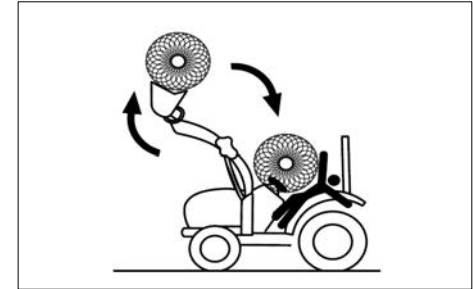

Never carry a big object with the loader unless a proper implement is attached.

Keep a carried object low during driving.

Otherwise, it may lead to an injury or even death.



SAFETY PRECAUTIONS

► TOWING SAFELY

For the maximum towable loads, refer to the 'TIRE AND MASS' section in appendix chapter if available.

Maintain a suitable speed taking into account the weight of the trailed load and the gradient, remembering that braking distances will be greater than with just the tractor.

Trailed loads with or without brakes that are too heavy for the tractor or that towed at too high speed may cause the operator to lose control of the tractor.

Always take into consideration the total weight of the implements and their loads.



CAUTION

- Before you leave the driving seat when a trailer is hitched to the tractor, remember to put all the controls in neutral, apply the parking brake, switch off the engine, engage first gear (if the tractor has a mechanical transmission) and remove the key from the starter switch.
If the tractor is not parked on level ground, always place chocks under the wheels of both the tractor and the trailer.

► TRANSPORT TRACTOR BY TRUCK

Always secure the tractor to the loader bed with chains.

Before transporting the tractor on a low loader or on a railway wagon, make sure that the engine hood, doors, openable roof (if present) and windows are all closed and securely fastened.

Never tow the tractor at speeds in excess of 10km/h.

An operator must stay in the operator position to steer and brake the tractor.



► FALLING OBJECT PROTECTIVE STRUCTURE (FOPS)

The term FOPS refers to structure installed on the tractor intended to reduce the risk to the operator of injury from falling objects during normal use of the vehicle

IMPORTANT

- This tractor is not equipped with a FOPS.
- The energy level of drop test is 1365J.

► OPERATOR PROTECTIVE STRUCTURE (OPS)

The term OPS refers to a protective structure installed on a tractor in order to minimize risk of operator injury caused by objects penetrating into the operator position area.

DANGER

- This tractor is not equipped with an OPS. If work must be performed in areas subject to the risk of the penetration of objects into the operator position, consult your dealer before starting work so that the tractor can be equipped with an appropriate protective structure.

► USE OF HAZARDOUS SUBSTANCES

European standard EN 15695-1 is applicable to the cabs of agricultural or forestry tractors and self-propelled sprayers.

The purpose of the standard is to limit the exposure of the operator (driver) to hazardous substances when applying plant protection products and liquid fertilizers.

In accordance with the stipulations of EN 15695-1 regarding cab classification, measurement of the internal positive pressure differential must be carried out in conformance with ISO 14269-5:

- The engine operating at nominal speed;
- The maximum quantity of air drawn from outside the cab (recirculation closed);
- Fan set to maximum speed.



SAFETY PRECAUTIONS

The following terms and definitions are applied:

- **Hazardous substances:** substances such as dust, vapours and aerosols, with the exception of fumigants which can be dispersed during the application of plant protection products and liquid fertilizers, which may have a harmful effect on the operator.
- **Dust** general term identifying solid air-borne particles, finely divided and accumulated.
- **Aerosol:** suspension of solid, liquid or solid and liquid particulate in a gaseous medium with a negligible fall rate (generally less than 0.25 ms⁻¹)
- **Vapour:** gaseous phase of a substance whose liquid or solid state is stable at 20°C and 1 bar (absolute).
This cab, even when closed, does not protect against the inhalation of hazardous substances.

If the manufacturer's instructions for using these substances recommend personal protective equipment, wear the equipment even in the cab.

Cabs are classified as follows:

- **Category 1:** the cab does not provide protection against hazardous substances.
- **Category 2:** the cab provides protection exclusively from dust.
- **Category 3:** the cab provides protection from dust and aerosol.
- **Category 4:** the cab provides protection from dust, aerosol and chemical vapours.

The classification category, as stipulated by ISO 14269-5, of the cab installed on this range of tractors is given below:

- the engine operating at nominal speed
- the maximum quantity of air drawn from outside the cab (recirculation closed) with fan at maximum speed.

Table 2 – Technical data

ROPS / CABIN	CATEGORY
Hazardous substances protection category	1

DANGER

- Use all the personal protective equipment suitable for the tasks in hand and relative substances, in compliance with the requirements of statutory legislation in your country.



2. SAFE OPERATION OF YOUR TRACTOR

The manufacturer of your tractor has made every effort to make it as safe as is humanly possible.

Beyond this point it is the responsibility of the operator to avoid accidents and we ask that you read and implement our suggestions for your safety.

Ensure that only trained and competent operators use this tractor and ensure that they are fully conversant with the machine and aware of all its control and safety features.

Operators should not operate the tractor or associated machinery while tired or untrained.

To avoid accidents please ensure that the operator wears clothing which will not get entangled in the moving parts of the tractor or machine and protect him or her from the elements.

When spraying or using chemicals, please ensure that clothing and protective equipment is worn which prevents respiratory or skin problems.

For full details consult the manufacturer of the chemicals.

To avoid lengthy exposure to noise ensure that ear protection is worn.

If adjustment to the tractor or machinery need to be made ensure the tractor or machine are turned off beforehand.

Use of certified Roll Over Protection Structure (ROPS) is a must while operating a tractor.

Use of seat belt is a must while operating a tractor.

In summary, ensure at all times that the safety of the operator and any other worker is paramount.

Ensure no one is between the tractor and a towed vehicle (trailer or implement).



SAFETY PRECAUTIONS

► SAFETY TIPS DURING MAINTENANCE

1. At least on a daily basis check all oil levels. Water level in the radiator and electrolyte level in the battery and perform services according to the service schedule.
wheels choked.
Where a tractor is started in a confined area, ensure that the area is well ventilated as exhaust gases are very harmful, and can cause death.
2. Ensure tire pressure are even and the correct pressure for the job being done is maintained.
3. Check to ensure that the all controls and preventative mechanisms of the tractor and implement work correctly and effectively.
4. Ensure that an adequate set of the correct tools is available for maintenance and minor repairs.
5. Ensure that all service work and repairs are carried out on a flat area with a concrete or similar floor.
Do not carry out service work on a tractor until it is switched off, and the parking brake applied and
6. Do not work under raised implements.
7. When changing wheels or tires ensure that a suitable wheel stand is placed under the axle prior to removing the wheel and the wheels are chocked.
8. Where guards or shields need to be removed to perform a service or repair, ensure that the guard or shield is correctly reinstalled before starting the tractor.
9. Never refuel near a naked flame or with an overheated engine.
Ensure to turn off Engine before refueling.
10. The cooling system operates under pressure, take care when removing the radiator cap on a hot engine to prevent being scalded by steam or hot water.
Do not add water in the radiator when the engine is hot.
Add water to the radiator only after the engine cools down completely.
11. To prevent fires keep the tractor including the engine clean and free from inflammable material and well away from fuels and other inflammable material.



► MOUNTING AND DEMOUNTING IMPLEMENTS

1. Ensure that all mounting and removal of implements is done on safe flat ground. Ensure no one is between the tractor and implement and do not get under the implement to avoid accidental injuries.
2. After mounting the implement, ensure that all sway chains are correctly adjusted and, where PTO shafts are used that the shaft is fitted and secured correctly.
3. Where heavy implements are used, ensure that the combination is well balanced or use proper ballast to achieve balance.
4. Before leaving the tractor at any time, lower the implement, stop the PTO shaft where applicable, set the parking brake and switch off the engine.
5. While operating the implements with the PTO keep all bystanders away from any moving parts and do not attempt to make adjustments while the machine is running.
6. Only the driver should ride on the tractor with the ROPS frame fitted and with the seat belt properly fastened.
7. Where young children are present, particular care should be taken and the tractor should not be moved until the whereabouts of all children is known.
8. Only trained operators should operate the tractor and so taking care to ensure that other workers are not injured. In particular they should take care during dusty operations, which will reduce visibility substantially.
9. Never start the tractor unless the transmission is out of gear, the operator is in the seat and all round safety has been checked.
10. Only operate the tractor seated in the driver's seat and never turn or brake suddenly at high speed as this can cause a roll-over and serious injury or death.
11. When traveling on a public road ensure that the tractor and driver both meet all laws relating to safety and licensing. When traveling with wide implements use red flags on the extremities and observe all legal including escort requirements.
12. When operating under adverse conditions, hilly terrain or on bad ground adjust the speed of the tractor to suit the conditions, safety



SAFETY PRECAUTIONS

comes first.

Never drive down-hill at high speed or with the transmission in neutral. Use of the braking capacity of the engine as well as the service brakes. Do not try to change gear going up or down a steep slope, select the correct gear before starting.

13. Take care when traveling uphill with a heavy implement to ensure that it does not overbalance and tip up the front end.
14. Never remove or modify the seat belt.
15. Never remove, modify or repair the ROPS frame.

Please remember that a little bit of extra care can prevent serious injury or death and avoid damage to your tractor.

► THE FOLLOWING PRECAUTIONS ARE SUGGESTED TO HELP PREVENT ACCIDENTS

A careful operator is the best operator. Most accidents can be avoided by observing certain precautions.

Read and take the following precautions before operating the tractor to prevent accidents.

Tractor should be operated only by those who are responsible and properly trained to do so.

<THE TRACTOR>

1. Read the operator's manual carefully before using the tractor. Lack of operating knowledge can lead to accidents.
2. Use an approved rollover bar and seat belt for safe operation. Overturning of a tractor without a rollover bar can result in death or injury.
3. Do not remove ROPS (Roll Over Protective Structure). Always use the seat belt.
4. Fiberglass canopy does not give any

protection.

5. To prevent falls, keep steps and platform clear of mud and oil.
6. Do not permit anyone but the operator to ride on the tractor. There is no safety place for extra riders.
7. Replace all missing, illegible or damaged safety signs.
8. Keep safety signs clean of dirt and grease.

<SERVICING THE TRACTOR>

1. keep the tractor in good operating condition for your safety. An improperly maintained tractor can be hazardous.
2. Stop the engine before performing any service on the tractor.
3. The cooling system operates under pressure, which is controlled by the radiator cap. It is dangerous to remove the cap while the system is hot.



First turn the cap slowly to stop and allow the pressure to escape before removing the cap entirely.

4. Do not smoke while the refueling the tractor.
Keep away any type of open flame.
5. The fuel in the injection system is under high pressure and can penetrate the skin.
Unqualified persons should not remove or attempt to adjust a pump, injector, nozzle or any part of the fuel injection system.
Failure to follow these instructions can result in serious injury.
6. Keep open flame away from battery or cold weather starting aids to prevent fire or explosions.
7. Do not modify or alter or permit anyone else to modify or alter this tractor or any of its components or any tractor functions.

<OPERATING THE TRACTOR>

1. Before starting the tractor apply the parking brake, place the PTO (Power Take Off) lever in the “OFF” position, the position control levers in the downward position, the hydraulic control levers in the neutral position (If fitted) and the transmission in neutral.
2. Do not start the engine or controls while standing beside the tractor. Always sit on the tractor seat when the engine or operating controls.
3. Safety start:
In order to prevent the accidental starting of the tractor, a safety switch has been provided. The starting system of the tractor is connected through this switch. On some models shuttle shifter lever and PTO button should also be in neutral position for completing the starting circuit. Do not bypass the safety switch. Consult your TYM tractor

distributor / dealer if safety switch malfunctions.

4. Avoid accidental contact with the gear shifter lever while the engine is running.
Unexpected tractor movement can result from such contact.
5. Do not get off or climb the tractor while it is in motion.
6. Shut off the engine, remove the key and apply the parking brake before getting off the tractor.
7. Do not operate the tractor in an enclosed building without adequate ventilation.
Exhaust fumes can cause death.
8. Do not park the tractor on a steep slope.
9. If power steering or Engine seizes to operate, stop the tractor immediately.
10. Pull only from the swinging draw bar or the lower link drawbar in the down position. Use only a drawbar pin that locks in place.



SAFETY PRECAUTIONS

Pulling from the tractor rear axle carriers or any point above the rear axle may cause the tractor's front end to lift.

11. If the front end of the tractor tends to rise when heavy implements are attached to the three point linkage, install front end or front wheel weights.
Do not operate the tractor with a light front end.
12. Always use hydraulic position control lever when attaching equipment / implement and when transporting equipment.
Be sure that the hydraulic couplers are properly mounted and will disconnect safely in case of accidental detachment of implement.
13. Do not leave equipment/implement in the raised position.
14. Use the flasher / turn signal lights and Slow Moving Vehicle (SMV) signs when driving on public roads

during both day and night time, unless prohibited by law.

15. Dim tractor lights when meeting a vehicle at night.
Be sure the lights are adjusted to prevent the blinding on the eyes of coming vehicle operator.
16. Emergency stopping instruction; If tractor fails to stop even after application of brakes.
Pull the knob of fuel shut off control rod.

<DRIVING THE TRACTOR>

1. Watch where you are going especially at row ends, on roads, around trees and low hanging obstacles.
2. To avoid upsets, drive the tractor with care and at speeds compatible with safety, especially when operating over rough ground, crossing ditches or slopes, and when turning at corners.

3. Lock the tractor brake pedals together when transporting on roads to provide proper wheel braking.
4. Keep the tractor in the same gear when going downhill as used when going uphill.
Do not coast or free wheel down hills.
5. Any towed vehicle and/or trailer whose total weight exceeds that of the towing tractor, must be equipped with its own brakes for safe operation.
6. When the tractor is stuck or tires are frozen to the ground, back out to prevent upset.
7. Always check overhead clearance, especially when transporting the tractor.



<OPERATING THE PTO>

1. When operating PTO driven equipment, shut off the engine and wait until the PTO stops before getting off the tractor and disconnecting the equipment.
2. Do not wear loose clothing when operating the power take-off or near rotating equipment.
3. When operating stationery PTO driven equipment, always apply the tractor parking brake and block the rear wheels from front and rear side.
4. To avoid injury, always move down flip part of PTO.
Do not clean, adjust or service PTO driven equipment when the tractor engine is running.
5. Make sure the PTO master shield is installed at all times and always replace the PTO shield cap when the PTO is not in use.

<DIESEL FUEL>

1. Keep the equipment clean and properly maintained.
2. Under no circumstances should gasoline, alcohol or blended fuels be added to diesel fire or explosive hazard.
Such blends are more explosive than pure gasoline. In a closed container, such as a fuel tank. DO NOT USE THESE BLENDS.
3. Never remove the fuel cap or refuel the tractor with the engine running.
4. Do not smoke while refueling or when standing near fuel.
5. Maintain control of the fuel filler pipe when filling the tank.
6. Do not fill the fuel tank to capacity. Allow room for expansion.
7. Wipe up spilled fuel immediately.
8. Always tighten the fuel cap securely.
9. If the original fuel tank cap is lost, replace it with genuine cap.
A none approved cap may not be safe.

10. Do not drive equipment near open fire.
11. Never use fuel for cleaning purpose.
12. Arrange fuel purchases so that winter grade fuel are not held over and used in the spring.
13. Use ultra-low sulfur fuel only.

IMPORTANT

- It is suggested that after repairs if any of the safety decals or signs are peeled or defaced, the same may be replaced immediately in interest of your safety.



SAFETY PRECAUTIONS

3. DOs & DON'Ts

► DOs – FOR BETTER PERFORMANCE

- DO** - Ensure that safety shields are in place and in good condition.
- DO** - Read all operating instructions before commencing to operate tractor.
- DO** - Carry out all maintenance tasks without fail.
- DO** - Keep the air cleaner clean.
- DO** - Ensure that the correct grade of lubricating oils is used and that they are replenished and changed at the recommended intervals.
- DO** - Fit new sealing rings when the filter elements are changed.
- DO** - Watch the oil pressure gauge or warning light and investigate any abnormality immediately.
- DO** - Keep the radiator filled with clean water and in cold weather use anti-freeze mixture.
Drain the system only in an emergency and fill before starting the engine.
- DO** - Ensure that the transmission is in neutral before starting the engine.
- DO** - Keep all fuel in clean storage and use a filter when filling the tank.
- DO** - Attend to minor adjustments and repairs as soon as necessity is apparent.
- DO** - Allow the engine to cool before removing the radiator filler cap and adding water, remove the radiator cap slowly.
- DO** - Shift into low gear when driving down steep hills.
- DO** - Latch the brake pedals together when driving on a highway.
- DO** - Keep draft control lever fully down when not in use.

**► DON'Ts – FOR SAFE OPERATION**

DON'T - Run the engine with the air cleaner disconnected.

DON'T - Start the tractor in an enclosed building unless the doors and windows are open for proper ventilation.

DON'T - Operate the tractor or engine while lubricating or cleaning.

DON'T - Allow the tractor to run out of diesel fuel otherwise it will be necessary to vent the system.

DON'T - Temper the fuel injection pump, If seal is broken the warranty becomes void.

DON'T - Allow the engine to run idle for a long period.

DON'T - Run the engine if it is not firing on all cylinders.

DON'T - Ride the brake.
This will result in excessive wear of the brake lining.

DON'T - Use the independent brakes for making turns on the highway or at high speeds.

DON'T - Refuel the tractor with the engine running.

DON'T - Mount or dismount from the right side of the tractor.

DON'T - Temper the hydraulic control levers' upper limit stops.

DON'T - Use draft control lever for lifting of implements.

DON'T - Start the engine with the PTO engaged.

DON'T - Use the throttle lever while driving on roads.

DON'T - Move the hydraulic levers rearward.



SAFETY PRECAUTIONS

4. SAFETY DECALS

► GENERAL INFORMATION OF DECALS

- In order to work with the machine safely, safety decals should be placed on the machine.
- Make sure to read and follow the following directions.

■ **KEEP THE WARNING LABELS CLEAN AND NOT DAMAGED AT ALL TIMES.**

If a decal on the machine is dirty, wash it with soapy water and wipe it off with a soft cloth. Never use solution such as thinner or acetone because these can erase characters or pictures.

■ **IF WASHED WITH HIGH PRESSURED WATER, A DECAL MAY BE PEELED OFF.**

Do not apply high pressured water directly onto decals.

■ **IF A SAFETY DECAL IS DAMAGED OR LOST, ORDER A NEW ONE IMMEDIATELY AND PLACE IT ON THE MACHINE.**

When putting a new decal, wipe off the place to post the decal thoroughly and wait till it is dried. Then post the decal.
Each decal has a part number on the bottom.

■ **WHEN REPLACING A PART ATTACHED WITH A DECAL WITH A NEW PART, REPLACE THE DECAL AS WELL.**



► DECALS ON CHASSIS

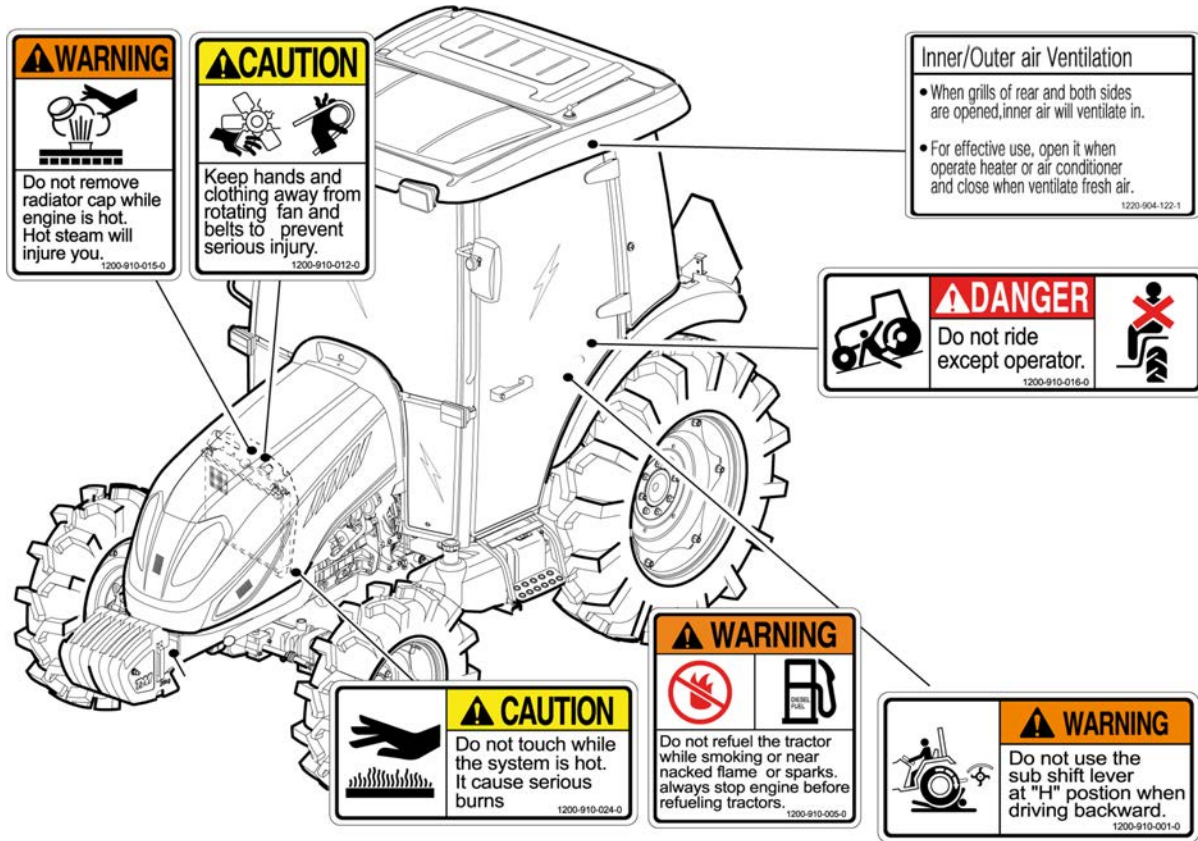

B



SAFETY PRECAUTIONS

⚠ DANGER

This Tractor may tip over unexpectedly and quicker than an operator is able to jump free

1. Never operate a tractor without a proper Roll over Protection Structure.(ROPS)
2. Always wear your seat belt when operating this tractor equipped with roll over protection.
3. Never pull from above or from the rear axle.
4. Do not operate the tractor on steep slopes or near drop offs
5. Avoid sharp high speed turns

Serious injury or death may result from tractor upsets.

1220-904-901-0

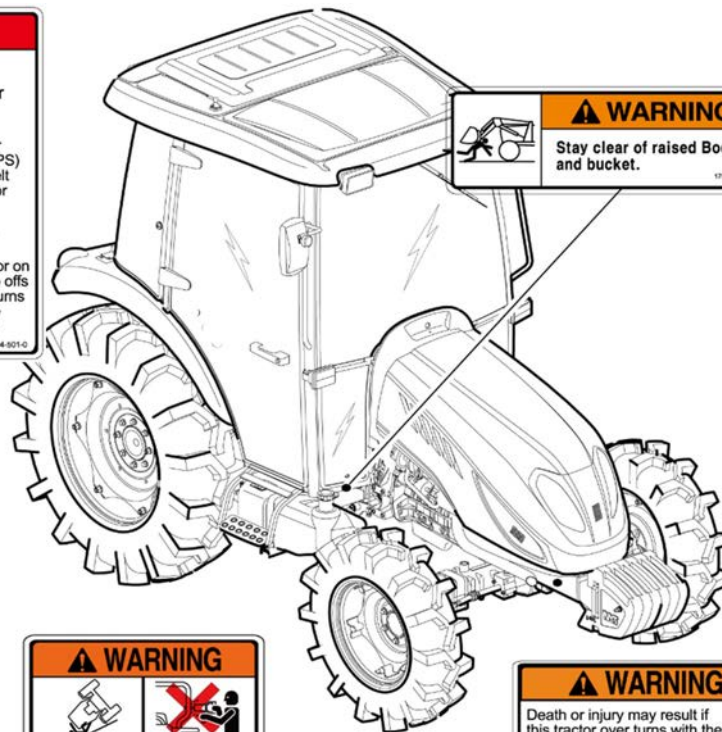

⚠ WARNING

Stay clear of raised Boom and bucket.

1798-910-010-0

⚠ WARNING

Additions, alterations, cracking, damage or corrosion to this structure may adversely affect the performance of the ROPS.

⚠ WARNING

Death or injury may result if this tractor over turns with the ROPS in the folded down position. Operate this tractor with the ROPS folded down only when necessary. Do not wear seat belt if operated with ROPS folded down

1220-904-902-0



⚠ WARNING

- Start engine only from operators seat. If safety start switch is by passed engine can start with transmission in gear.
- Do not connect or short across terminal on starter solenoid.
- Attach booster cables as shown on battery decal and operators manual.

Starting in gear causing runaway can result in serious injury.

⚠ WARNING

Always apply the park brake when parking. Failure to do so can cause accidents and damages.

1200-910-002-0

⚠ WARNING

Brake pedals must always be locked together when traveling on the highway. This will ensure uniform braking and provide maximum stopping ability sharp turns must only be made at slow speeds.

1200-910-007-0

⚠ WARNING

Do not adjust the tilt handle when traveling.

1200-910-008-0

⚠ WARNING

Do not use the accelerator lever except working on the field.

1200-910-021-0

OPERATION

TO PROTECT YOUR ENGINE:

- To allow the regeneration cycle to occur, the engine has a safety stop and regeneration will be limited.
- For the regeneration process, ...
- ... refer to the Operator's Manual.

Press this switch to stop automatic regeneration only. Do not press the switch repeatedly to prevent: ...

1200-910-014-0

⚠ WARNING

Attach implements and trailers to the tractor only using the prescribed draw-bar or hitch.

1200-910-014-0

⚠ DANGER

Rotating driveline contact can cause death. **KEEP AWAY!** Keep all drive line. Tractor and equipment shields in place during operation.

1200-910-013-0

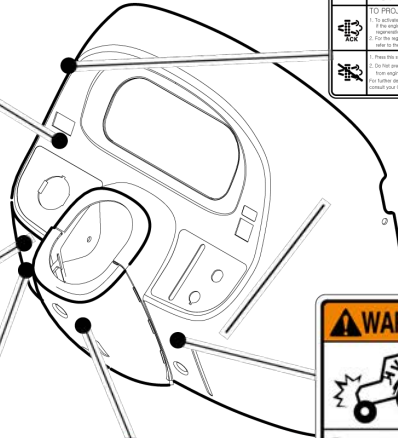
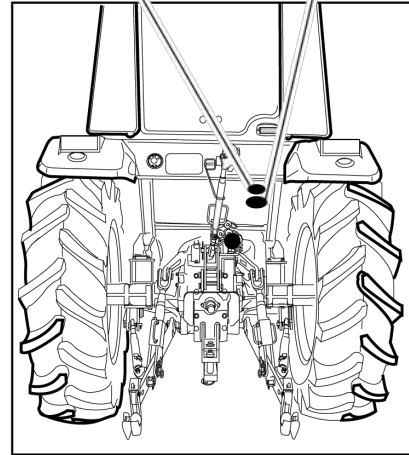

B





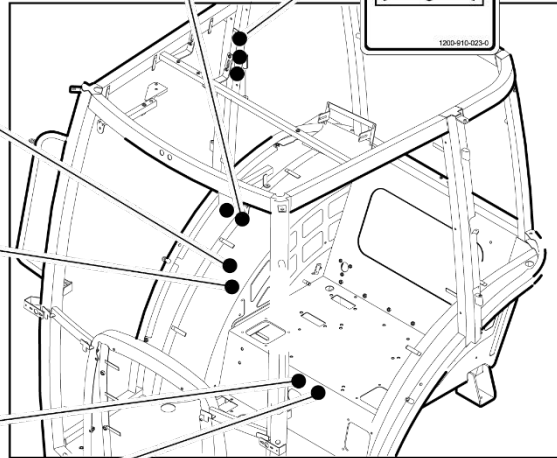



























SAFETY PRECAUTIONS



5. UNIVERSAL SYMBOLS

Some of the universal symbols have been shown below with an indication of their meaning.

DESCRIPTION	SYMBOL	DESCRIPTION	SYMBOL	DESCRIPTION	SYMBOL
ENGINE SPEED (REV/MIN X 100)		PRESSURED, OPEN SLOWLY		CORROSIVE SUBSTANCE	
HOURES, RECORDED		CONTINUOUS VARIABLE		SLOW OR MINIMUM SETTING	
ENGINE COOLANT TEMPERATURE		DANGER, WARNING, CAUTION		FAST OR MAXIMUM SETTING	
FUEL LEVEL		HAZARD WARNING		TRANSMISSION OIL PRESSURE	
ENGINE STOP CONTROL		NEUTRAL		TURN SIGNAL	
LIGHTS		FAN		TRANSMISSION OIL TEMPERATURE	
HORN		POWER TAKE OFF ENGAGED		PARKING BRAKE	
ENGINE OIL PRESSURE		POWER TAKE OFF DISENGAGED		WORKING LAMP	
AIR FILTER CONTAMINATED		RAISE LIFT ARM		DIFFERENTIAL LOCK	
BATTERY CHARGE		LOWER LIFT ARM		REFER TO OPERATOR'S MANUAL	



TRACTOR INSTRUMENTS

- 1. SWITCHES C - 2
- 2. MONITOR PANEL & GAUGES C - 7
- 3. CONTROL INSTRUMENTS C - 11
- 4. THREE POINT LINKAGE C - 17
- 5. CABIN C - 20



1. SWITCHES

► FIGURE OF DASHBOARD

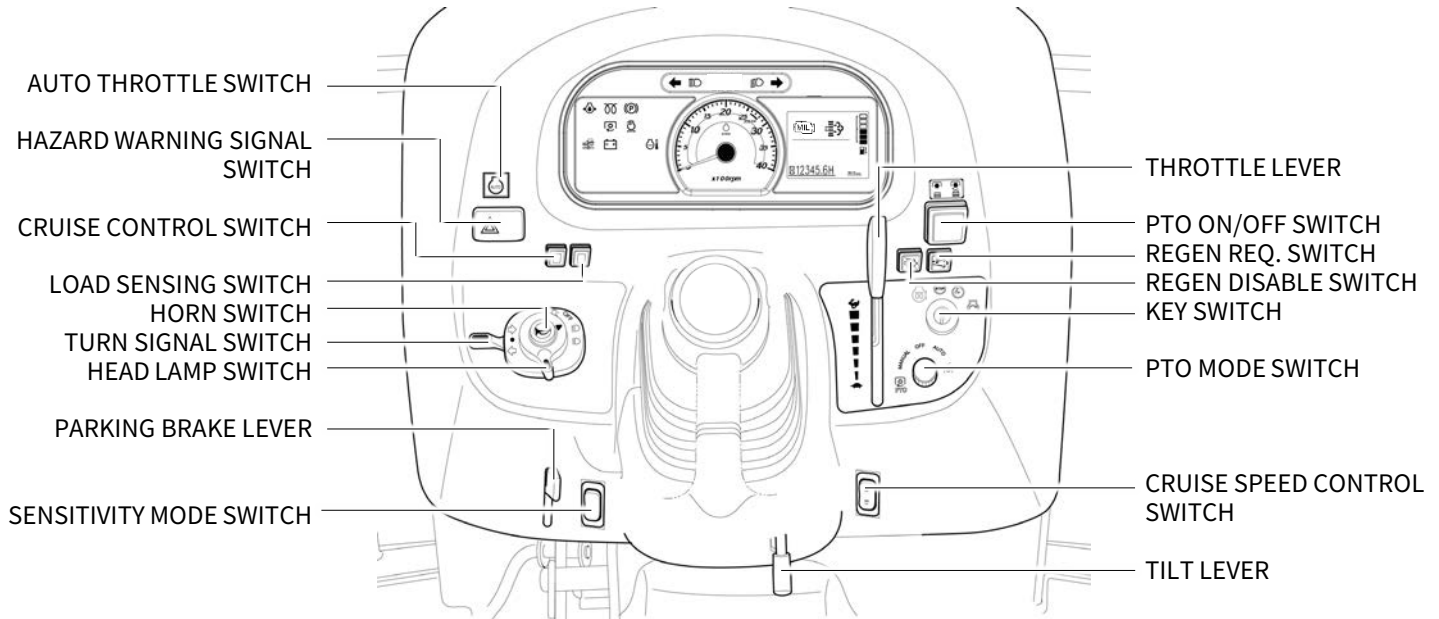

▶ **KEY SWITCH**

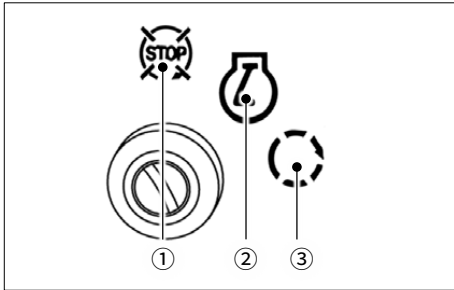

This switch is used to operate engine.

- ① GLOW – The engine’s combustion chamber is pre-heated in this position.
- ② OFF – The ignition key can be inserted and removed in this position
- ③ ON – The engine is kept running and switches are energized in this position.
- ④ START – The engine can be started in this position.
When releasing the key, the switch is returned to 「ON」 position.

▶ **COMBINATION SWITCH**

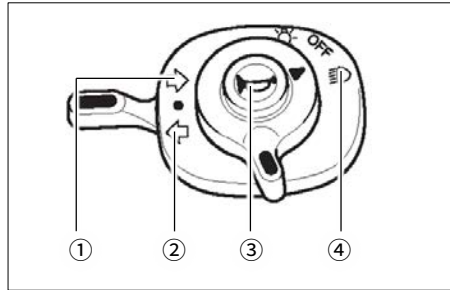

Turn signal lights, head light and horn can be operated with this switch.

- ① Right turn signal light
- ② Left turn signal light
- ③ Horn switch
- ④ Head light (low beam)

▶ **HAZARD WARNING SWITCH**

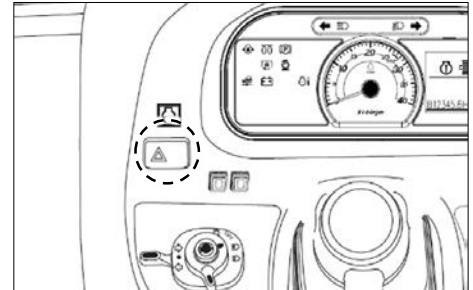

This switch can be used to warn other vehicles when malfunction occurs in the tractor while driving on public road. When pressing the switch once, left and right signal lights blink. To turn off, press the switch once again

IMPORTANT

- Use it only when necessary as it can discharge battery and obstruct other drivers.



▶ PTO ON/OFF SWITCH

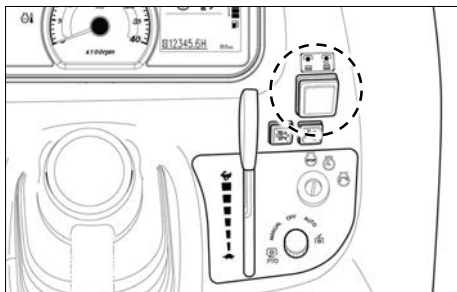

PTO ON/OFF switch is located on the LHS of the steering column and can be identified easily with its built in red colored indicator.

When the switch is pushed down to start the PTO indicator glows to indicate that the switch and the PTO are in ON position, If the switch is pushed down again the indicator goes off signaling that the PTO is OFF.

▶ PTO MODE SWITCH

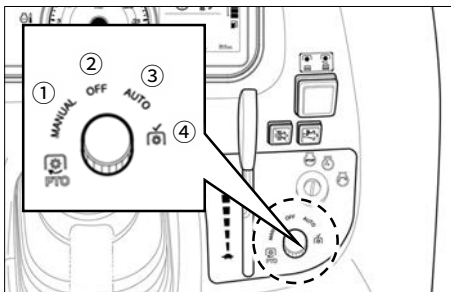

This switch is located near the starting key location on the dash panel. There are four positions marked for this switch.

1. OFF
2. MANUAL MODE
3. AUTO MODE
4. INTENTION MODE

The PTO shaft will not rotate if either of the PTO ON/OFF and PTO mode switch switches are in OFF position.

If switch is on intension mode, PTO keep rotating even operator leaves from the seat.

▶ AUTO THROTTLE SWITCH

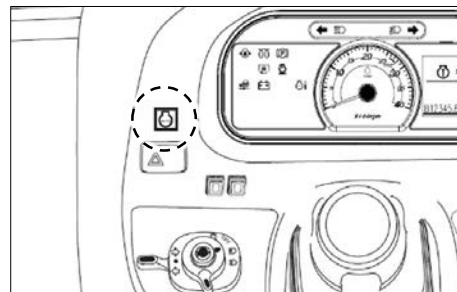

To activate the auto throttle function, press the button into the ON position. Then, the yellow indicator on the button and the symbol on the instrument cluster come on.

Depressing the speed control pedal in this state accelerates the vehicle to a certain speed level.

To deactivate the function, press the button again.

Then, the lamp goes off and the function is deactivated.

※ Load sensing function disabled during automatic throttle function operation.

► **CRUISE CONTROL SWITCH**

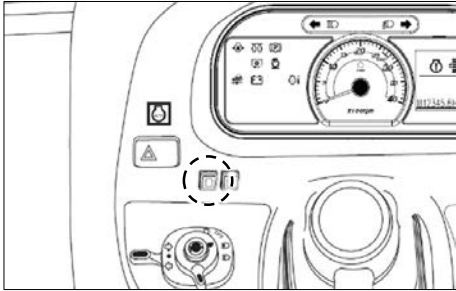

• **ENGAGING CRUISE CONTROL**

1. Depress the forward speed control pedal until the required speed is achieved.
2. Press the cruise control button to engage cruise control.
3. Release the forward speed control pedal.

The cruise control is only operational when the machine is traveling forward.

• **DISENGAGING CRUISE CONTROL**

To disengage the cruise control you can either press the cruise control button or depress the brake pedal.

► **CRUISE SPEED CONTROL SWITCH**

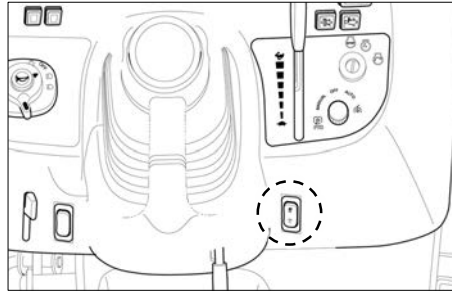

Cruise speed can be increased or decreased while cruise control is engaged.

- Press and release top of cruise speed control switch(+) to increase cruise speed by increment ratio. Press and release again to increase cruise speed more by increment ratio.
- Press and release bottom of cruise speed control switch(-) to increase by increment ratio. Press and release again to decrease cruise speed more by increment ratio.

Adjusted setting is erased when cruise control is disengaged.

► **SENSITIVITY MODE SWITCH**

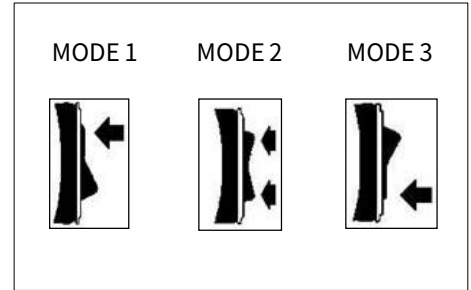
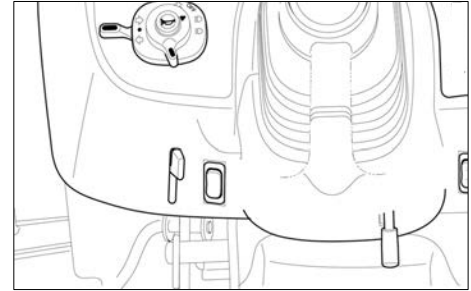

The tractor allows the user to choose a response sensitivity among three different modes.

C



- **MODE 1**

Fully depress top of mode switch to activate mode 1. This mode gives the higher response sensitivity to drive pedal movement.

It will provide more quick changes in speed or direction. The tractor would be more jerky.

- **MODE 2**

Depress top or bottom of mode switch to activate mode 2. This mode gives the medium response sensitivity to drive pedal movement which is typical to most normal operating conditions.

- **MODE 3**

Fully depress bottom of mode switch to activate mode 3. This mode gives the slow response sensitivity to drive pedal movement.

▶ REGEN REQ. SWITCH

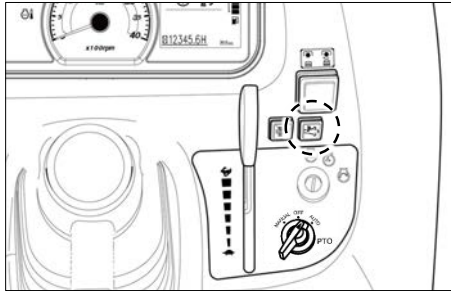

Press this switch to start regeneration manually.

Please refer 「OPERATION OF DPF」 in 「OPERATION」 section for more details.

▶ REGEN DISABLE SWITCH

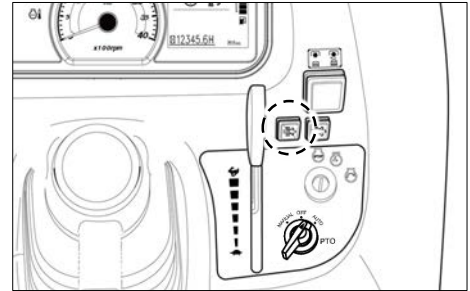

Press this switch to stop automatic regeneration.

Please refer 「OPERATION OF DPF」 in 「OPERATION」 section for more details.

2. MONITOR PANEL & GAUGES

► FIGURE OF MONITOR PANEL

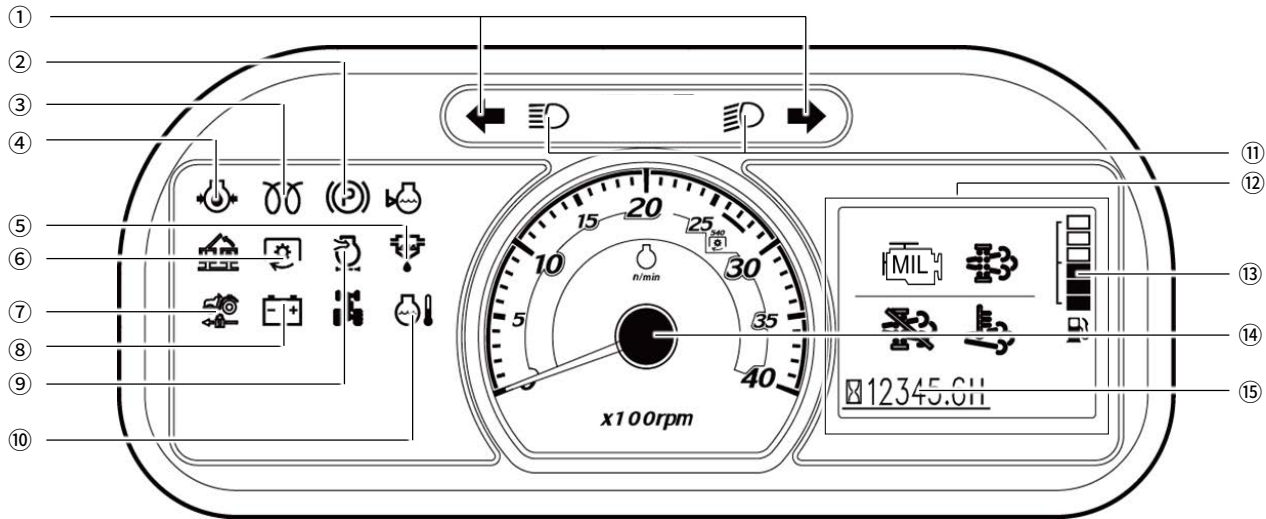

1. TURN SIGNAL LAMPS	2. PARKING BRAKE LAMP	3. GLOW LAMP	4. OIL PRESSURE WARNING LAMP
5. WATER IN FUEL WARNING LAMP	6. PTO LAMP	7. CRUISE CONTROL LAMP	8. CHARGE WARNING LAMP
9. AIR FILTER CONTAMINATED LAMP	10. COOLANT TEMPERATURE WARNING LAMP	11. LIGHT LAMP	12. LCD MONITOR
13. FUEL GAUGE	14. TACHO METER	15. HOUE METER	



▶ TACHO METER, HOUR METER

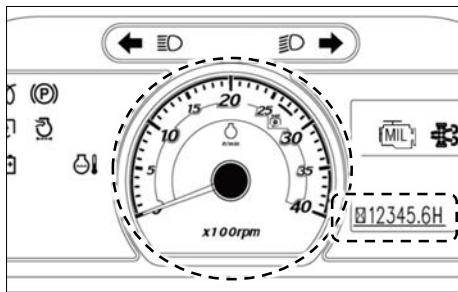

• TACHO METER

This meter shows the revolution of the engine and PTO shaft as well as travel speed.

• HOUR METER

This indicates total time of use. The last digit indicates 1/10th of an hour. Hourglass mark blinks during the operation.

✚ IMPORTANT

- The engine can be damaged if increasing its speed too fast.

▶ FUEL GAUGE, FUEL WARNING LAMP

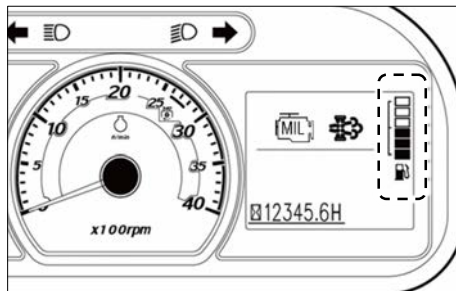

• FUEL GAUGE

This indicates amount of fuel while the key switch is 「ON」 position.

• FUEL WARNING LAMP

When fuel in the tank is almost empty, fuel warning lamp will blink.

✚ IMPORTANT

- Poor quality of fuel can damage the engine. Make sure to use only the specified genuine diesel fuel.

▶ TURN SIGNAL LAMPS, LIGHT LAMP

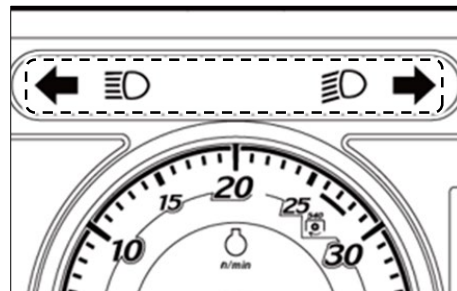

• TURN SIGNAL LAMPS

When turning turn signal light with combination switch, this lamps will blink with corresponding turn signal light of left or right.

• LIGHT LAMP

When turning head light with light switch in combination switch, this turns on simultaneously.

▶ **GLOW LAMP, ENGINE WARNING LAMP**

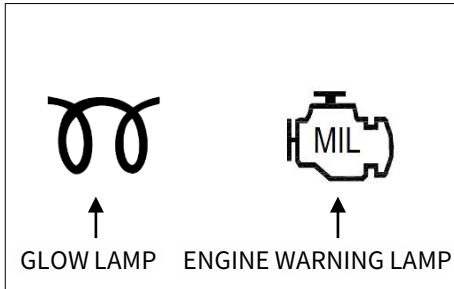

• **GLOW LAMP**

This comes on while engine preheating function is activated.

This will turn off as preheating is done.

• **ENGINE WARNING LAMP**

When engine malfunctions, this come on.

In this case, consult your dealer to determine the cause of the problem.

▶ **OIL PRESSURE WARNING LAMP, CHARGE WARNING LAMP**

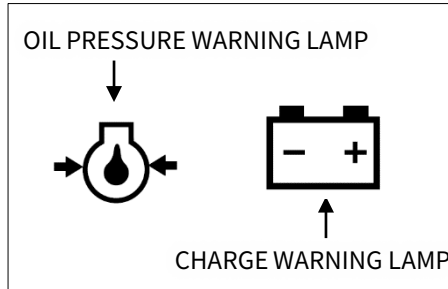

• **OIL PRESSURE LAMP**

This comes on when the engine oil lubrication problem occurs.

Stop the engine and check engine oil level or get help from a workshop.

This will comes on at engine starting and will go off soon.

• **CHARGE WARNING LAMP**

This comes on when battery charging is not working normally.

Please get a help from workshop as soon as possible.

This will comes on at engine starting and will go off soon.

▶ **COOLANT TEMPERATURE WARNING LAMP, PTO LAMP**

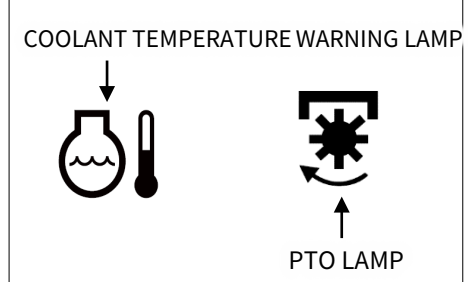

• **COOLANT TEMPERATURE WARNING LAMP**

This comes on when battery charging is not working normally.

Please get a help from workshop as soon as possible.

This will comes on at engine starting and will go off soon.

• **PTO LAMP**

This indicates state of PTO shaft.

This comes on while PTO switch is 「ON」 position.

Refer to 「OPERATION OF PTO」 section in 「OPERATION」 chapter for more details.



▶ PARKING BRAKE LAMP, CRUISE CONTROL LAMP

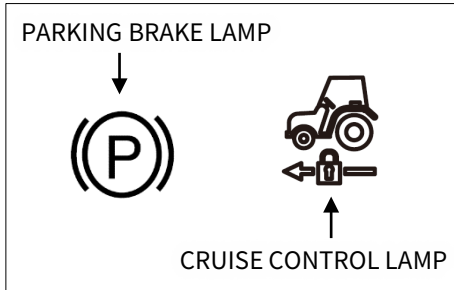

- **PARKING BRAKE LAMP**

This comes on when parking brake is engaged.

- **CRUISE CONTROL LAMP**

This comes on while the cruise control (constant speed setting) is activated.

▶ AIR FILTER CONTAMINATED LAMP, WATER IN FUEL WARNING LAMP

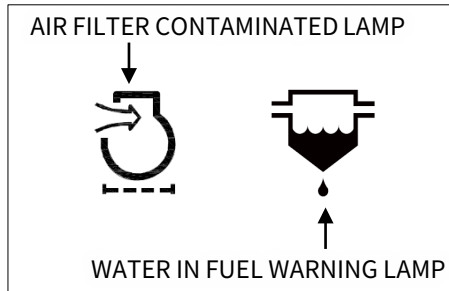

- **AIR FILTER CONTAMINATED LAMP**

This comes on when the air cleaner is clogged by foreign materials.

- **WATER IN FUEL WARNING LAMP**

When a certain amount of water is collected in the fuel filter, this lamp comes on. In this case, stop the engine and drain water from the fuel filter as soon as possible.

3. CONTROL INSTRUMENTS

► FIGURE OF TRACTOR CONTROLS

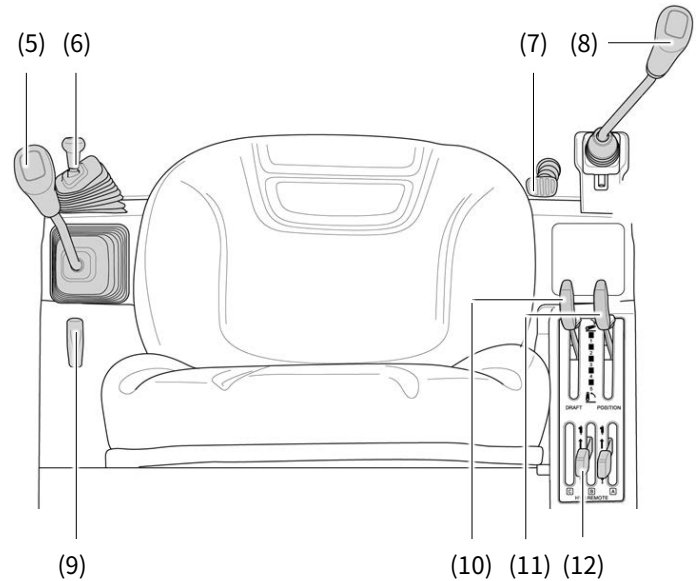
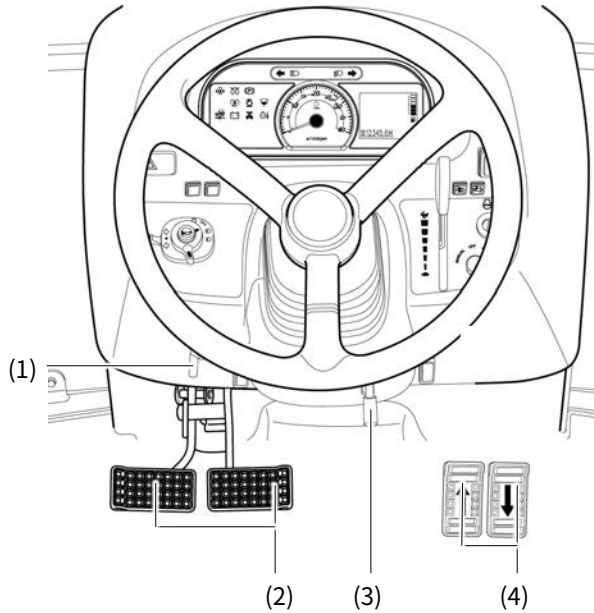

C

1. PARKING BRAKE LEVER	2. BRAKE PEDALS (L/R)	3. TILT LEVER	4. SPEED CONTROL PEDALS (F/R)
5. SUB SHIFT LEVER	6. PTO SHIFT LEVER	7. DIFFERENTIAL LOCK PEDAL	8. JOYSTICK LEVER
9. 4WD LEVER	10. DRAFT CONTROL LEVER	11. POSITION LEVER	12. REMOTE CONTROL LEVER



► BRAKE PEDALS

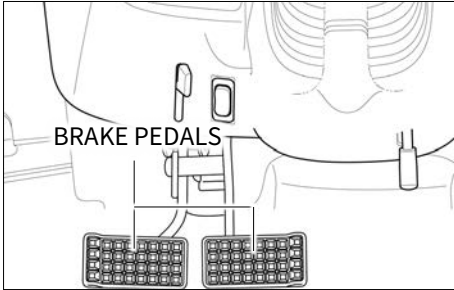

The brake is to stop the tractor forcibly. Unlike general automobiles, this tractor is equipped with left and right brake pedals.

Each brake pedal brakes only one side wheel on the corresponding side.

It is used for following functions.

- To stop the tractor
- To turn direction
- To release cruise control

IMPORTANT

- One side braking function can be used for making sharp turn.
- Never use turn using brake pedal on public road.

► PARKING BRAKE LEVER

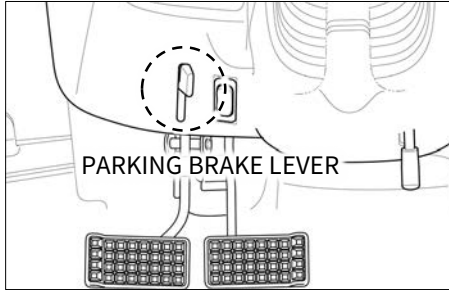

Pull the parking brake lever to apply parking brake.

► SPEED CONTROL PEDALS (F/R)

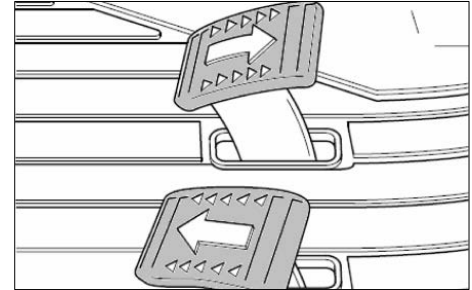

These are used to move the tractor forward or backward.

Travelling speed can be adjusted by amount of depressing pedal.

WARNING

- Always be careful during driving a road.

▶ **THROTTLE LEVER**

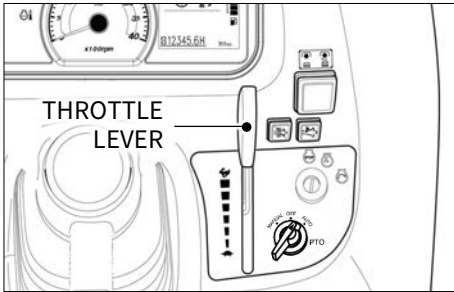

The hand operated throttle lever is located on the RHS of the dash cover.

To increase the engine speed, push the lever upward.

To decrease the engine speed, pull the lever downward.

The lever can be left in any position between idle and maximum as required.

▶ **SUB SHIFT LEVER**

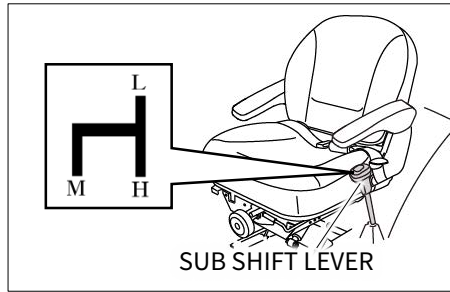

The driving direction can be selected between forward direction and reverse direction using the shuttle shift lever and range shift lever.

Use the throttle lever to increase / decrease the tractor speed.

- L : low speed
- M : middle speed
- H : high speed

 **WARNING**

- Be careful when driving backward as forward and backward travelling speed is almost same.
Use 「L」 shift when driving backward.

▶ **4WD LEVER**

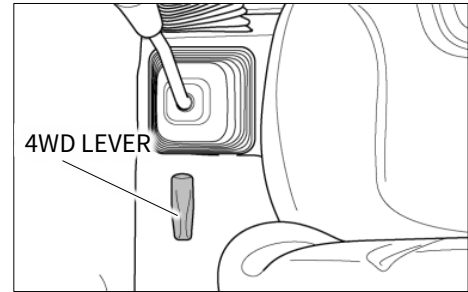

In the ON position, the front wheels are engaged and in the OFF position they are disengaged.

Engage & disengage the front wheel drive with the front wheels in the straight position and at low speed.

 **IMPORTANT**

- Before operating the 4WD lever, make sure to stop the tractor.
- If it is hard to engage 4WD lever, do not apply excessive force. Instead drive tractor forward or backward slightly and to engage the lever again.
- Avoid using 4WD on public road to reduce wear on tires.

C



► TILT LEVER

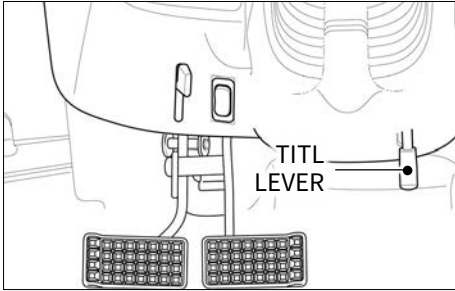

Adjust the inclination of the steering wheel to set it to the desired position.

► DIFFERENTIAL LOCK PEDAL

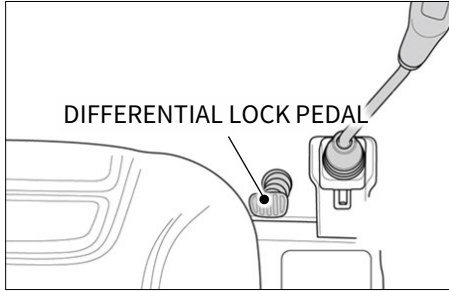

In case of wheel slippage use the differential lock by pushing down on the diff lock pedal. To release it remove the foot from the pedal.

WARNING

- Release the pedal during turning. Otherwise it can lead accident.

IMPORTANT

- If differential lock is still not disengaged after releasing the pedal, gently depress left and right brake pedals alternately.

► LOWERING SPEED CONTROL KNOB FOR 3 POINT LINKAGE

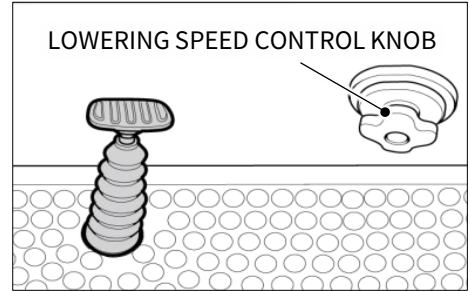

This controls the controls downward speed of hydraulics three point linkage.

- To slow the downward speed : Turn the knob clockwise.
- To increase the downward speed : Turn the knob anticlockwise.
- To lock the knob clockwise.

Do not over tighten the knob.

WARNING

- Set it to lock position under following conditions to prevent fall of implement:
 1. When driving on a public road.
 2. When replacing the rotavator blade or removing straws and grass.
 3. When servicing the implement.

▶ PTO SHIFT LEVER

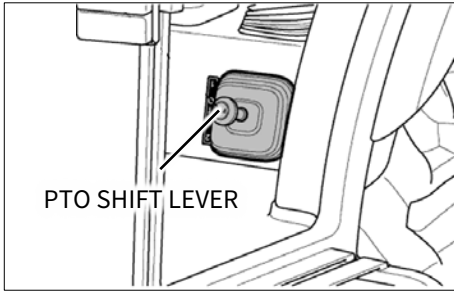

The tractor is equipped with 2 Speed PTO to suit range of applications and conditions.

<PTO SPEED>

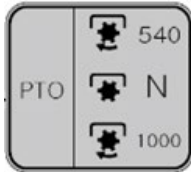

▶ POSITION LEVER

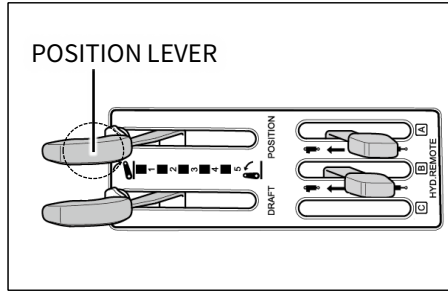

Implements can be raised and lowered with the hydraulic position control lever and can be stopped at any position by stopping the lever.

- **To raise the implement :**
Pull the lever backward
- **To lower the implement :**
Push the lever forward.

WARNING

- After finishing the work, always lower the implement to the ground to avoid injuries and accidents.

▶ DRAFT CONTROL LEVER

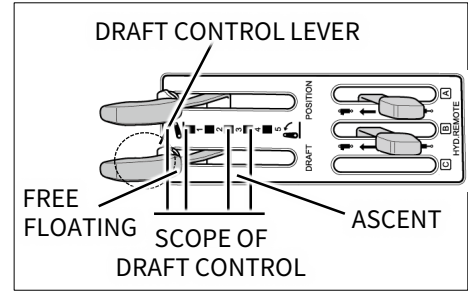

Soil engaging implements can be set for precision work by using draft control. By mounting the lever forward.

The depth increase & by moving the lever backwards the depth increases.

C



▶ REMOTE CONTROL LEVER

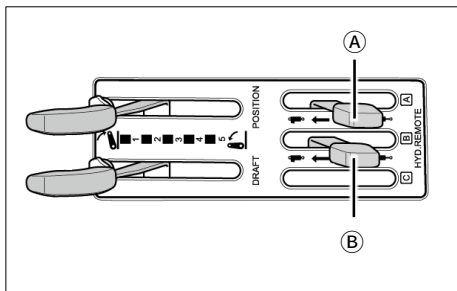

Move the lever up or down and hold. This will raise or lower the implement (rotavator or hydraulic plow).

- ① : Spring type – Double-acting with self-return.
- ② : Detent type – Double-acting with detent

Please refer to 「**IMPLEMENTS**」 in 「**D. OPERATION**」 chapter for connecting and disconnecting to implements.

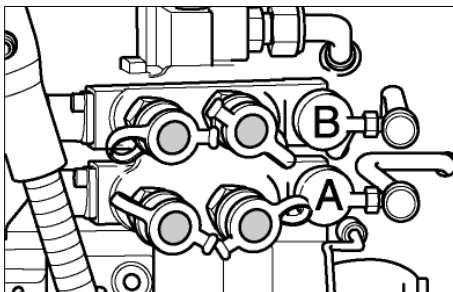

⚠ IMPORTANT

- Do not hold the lever in the “pull” or “push” position once the remote cylinder has reached the end of the stroke as this will cause oil to flow through the relief valve. Forcing oil through the relief valve for extended periods will overheat the oil.
- When using the tractor hydraulic system to power front loader, do not operate the boom and bucket cylinders simultaneously.

▶ JOYSTICK LEVER

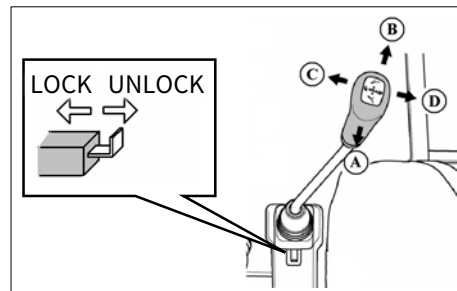

The joystick lever can control the use of a front-end loader. And lift-retract, dump-rollback smoothly and act as one handle lever.

- ① To raise the front end loader : pull the lever to lift position.
- ② To lower the front end loader : push the lever to retract position.
- ③ To roll-back the bucket : pull the stick to rollback position.
- ④ To dump the bucket : push the stick to dump position.

The joystick lock button is installed to lock or unlock the joystick by pushing or pulling the button.

4. THREE POINT LINKAGE

► FIGURE OF THREE POINT LINKAGE

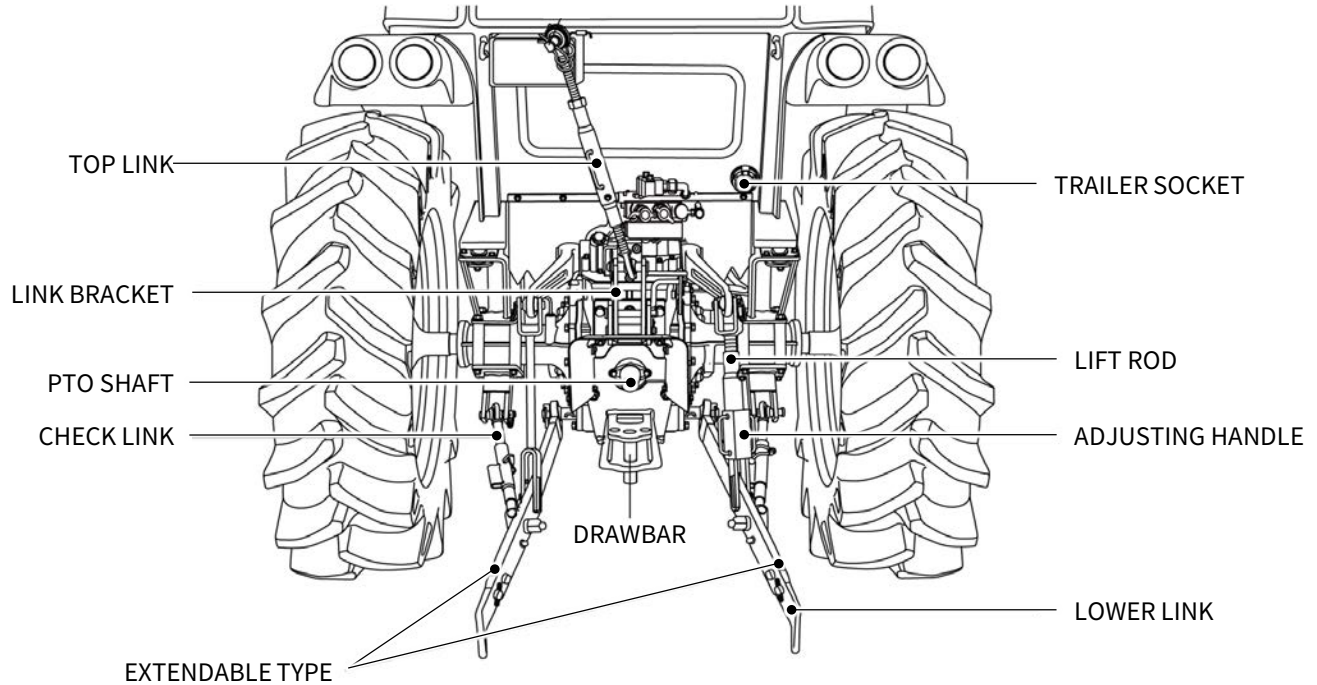



► TELESCOPIC STABILIZERS ADJUSTMENT

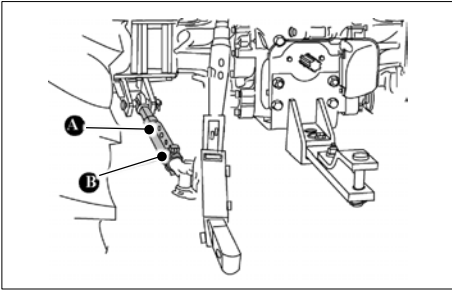

The stabilizers are intended for limiting or preventing implement side movement. There should be no clearance (Position A) during implement transport and when working with grades, rollers mowers, seeders, drills and similar implements. However, a slight play is necessary (Position B) when working with ploughs, harrows, ditches, cultivators and the like: That is when working with “draft control”.

The length of stabilizers is adjusted by removing the pin and rotating the turn buckle barrel by which the threaded ends are interconnected.

► ADJUSTMENT OF TOP LINK

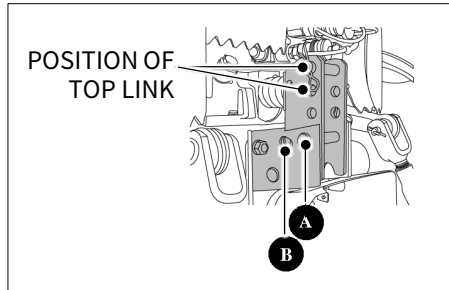
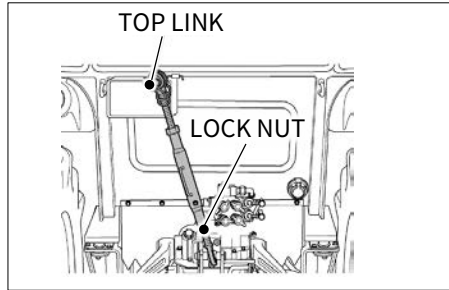

Lengthening or shortening the top link will change the angle of the implement. The locating hole of the top link varies with the type of implement used. The most common locations are the 1st and 2nd hole from the top.

- For general implement : Use the Pin to “A” point
- For draft control : Use the pin to “B” point

CAUTION

- It is dangerous to use implements at a high speed if it is designed to be operated at a low speed.
- Before using implements, make sure to read its owner’s manual.

► **ADJUSTMENT OF LOWER LINK**

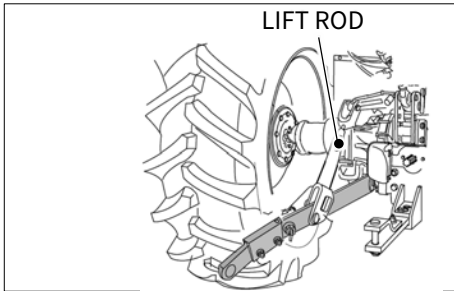

The adjustment is done with the adjusting handle on the right hand lift rod.

To shorten it wind the handle clockwise and to lengthen it wind it counter clockwise.

When adjusted correctly hold the turn buckle with the stopper provided.

► **ADJUSTMENT OF LIFT LINK ON LOWER LINK**

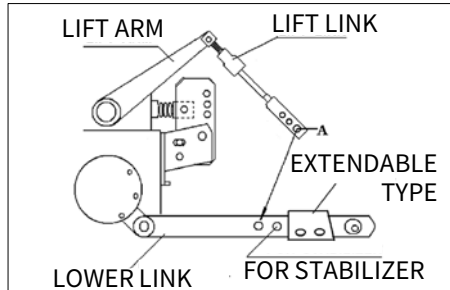

For different applications change the position of the lift rod on the lower links as shown and insert the pin in the direction of the arrow.

 **DANGER**

- Stay out of PTO shaft while it is rotating.
- If caught by PTO shaft, a severe injury or even death can occur.
- Do not remove PTO safety cover.
- Only use drawbar to tow and keep the 3 point linkage in the raised position when towing with the drawbar. Position can create unbalance causing the tractor to roll-over & result in the death or serious injury.

 **WARNING**

- Make sure to use the trailer hitch for towing to avoid rollover. Never tow anything by connecting a rope to the top link bracket, axle or safety frame.
- When using a rotavator that draws power through the universal joint from the PTO shaft, remove the trailer hitch from the tractor. Otherwise, the universal joint hits and damages the trailer hitch, leading to an accident.

C



5. CABIN

► FIGURE OF CABIN

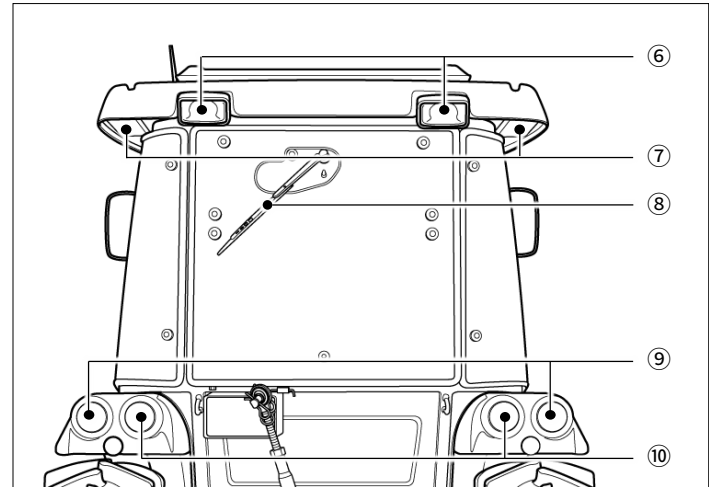
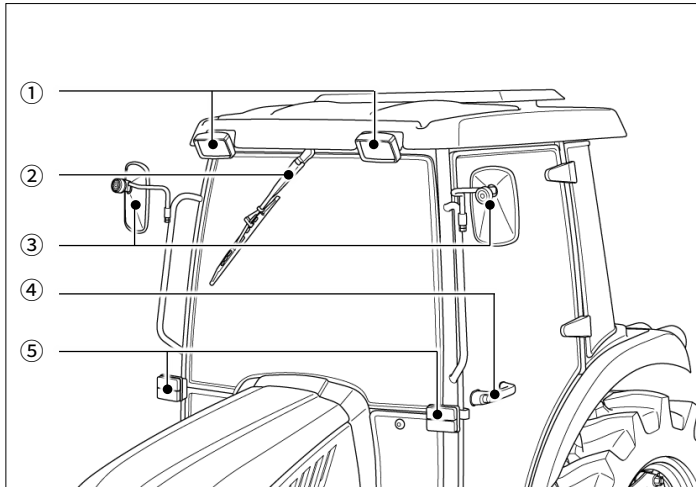

1. WORKING LAMP (FRONT)	2. WIPER (FRONT)	3. REARVIEW MIRROR	4. DOOR
5. TURN SIGNAL LAMP (FRONT)	6. WORKING LAMP (REAR)	7. AIR FILTER	8. WIPER (REAR)
9. TURN SIGNAL LAMP (REAR)	10. STOP LAMP		

► **CABIN IN GENERAL**

The cab fully conforms to the international standard as far as safety and soundproofing are concerned. It can be provided with ventilation, heating and air-conditioning system. It is available in the following version:

- Cabin with ventilation and heating systems
- Cabin with ventilation, heating and air-conditioning systems.

 **CAUTION**

- The cab is in full conformity with the international standards as to the cab's soundproofing.
- Be very careful when operating in small spaces and always protect your ears whenever other working equipment is generating dangerous noise levels.
- Remember that steering, braking and operational performances are highly influenced by the implements mounted, the trailers transported and the ballasts applied to the tractor.
- When transporting heavy loads (exceeding the weight of the tractor) reduce the speed under 15 Km/h.

 **CAUTION**

- All the implements mounted onto the tractor must be safely secured.
- Be very careful during implement hitching and unhitching operations. When using implement supports, be sure they are suitable and sufficiently strong.

► **DOORS**

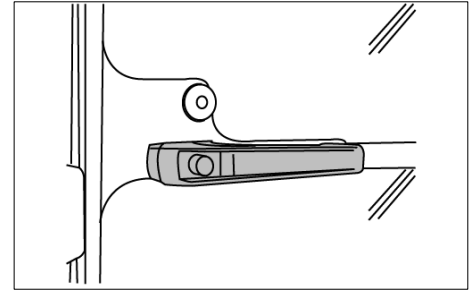

The doors are provided with key locks. To open from the outside, when unlocked, depress the push button. To open from inside, push the lever downwards.

C



► REAR WINDOW

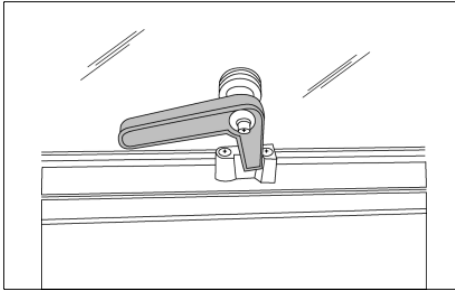

The rear window is fitted with central handle for opening. When opened it is held in place by two dampers.

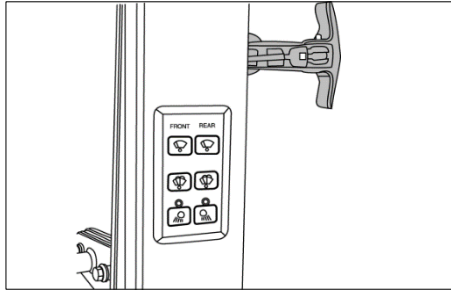

The side window is fitted with central handle for opening. When opened it is held in place by holder.

► WORKING LAMPS

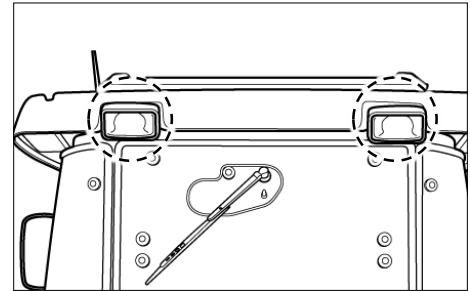
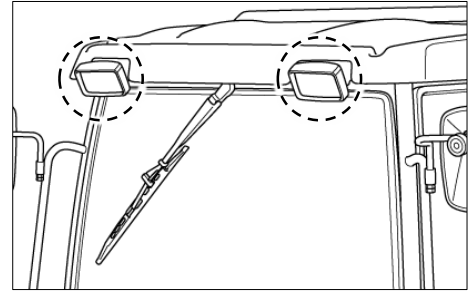

The working lamps are located on the cab roof (two in the front and two in the rear). They are switched on by means of the special switches on the roof console.

► **REARVIEW MIRRORS**

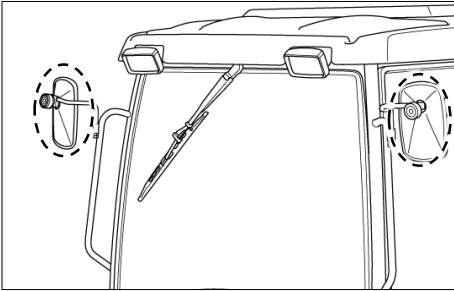

The cab is provided with rearview mirrors on both sides. They can be adjusted and folded, whenever necessary, to avoid interference with external obstacles. The mirrors have a telescopic arm to allow positioning for maximum convenience by the user. Remember that mirrors must always be positioned in compliance with road traffic regulations when driving on a public highway.

► **CABIN CEILING**

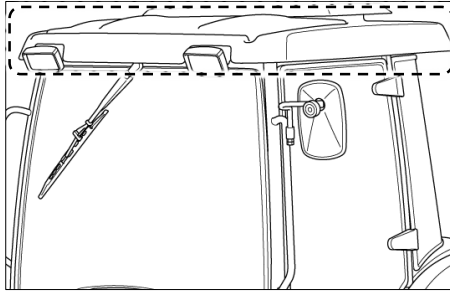

The ceiling is padded with insulation material to block heat radiation into the cab and keep the temperature down when working in very sunny areas. The cab platform is covered with a “firm grip” carpet in the most commonly used areas. It is recommended to keep this carpet clear of earth, mud, etc. so that the operator may get on and off the tractor in full safety.



► INSIDE OF CABIN

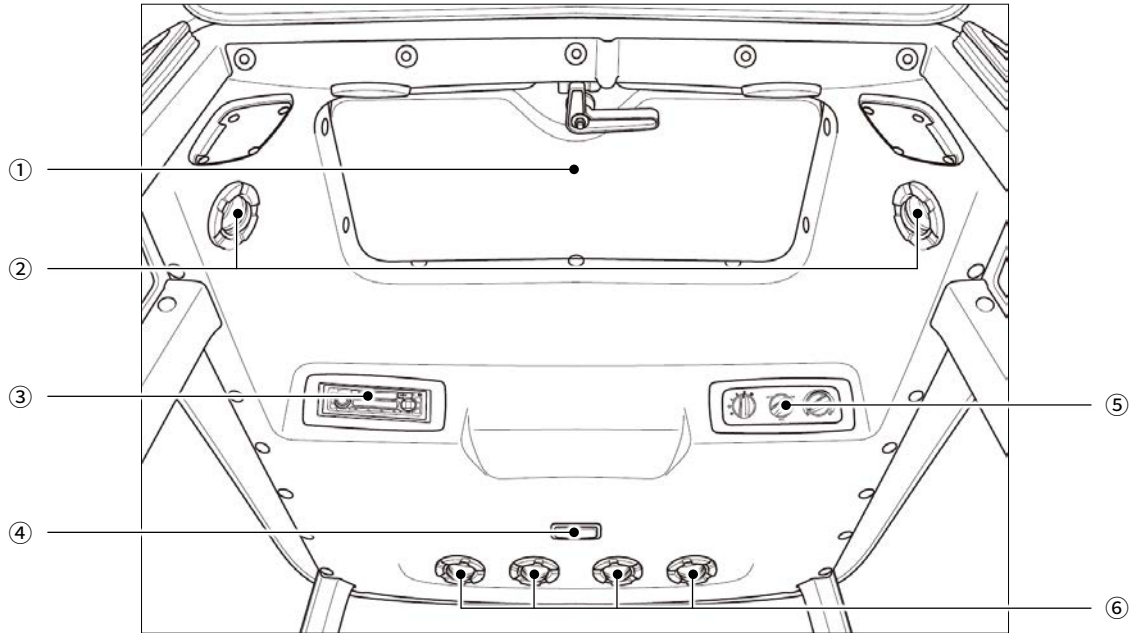

1. SUN VISOR (OPTION)	2. RECIRCULATION INLET	3. AUDIO SYSTEM	4. INTERIOR LAMP
5. A/C, HEATER SYSTEM	6. AIR VENTS		

► **WORKING LAMP, WIPER, WASHER CONTROL PANEL**

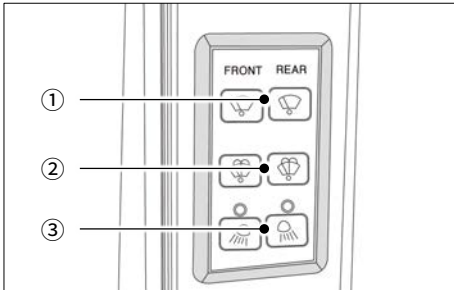

• **WIPER SWITCH**

Push ① buttons (front or rear) to work wiper.

The work light indicator lamp on the instrument cluster will illuminate.

• **WINDOW WASHER SWITCH**

Push ② buttons (front or rear) to work window washer.

During winter, it is advisable to add a suitable antifreeze or methyl alcohol to the windscreen washer fluid.

• **WORKING LAMP SWITCH**

Push ③ buttons (front or rear) to work working lamp.

► **INTERIOR LAMP**

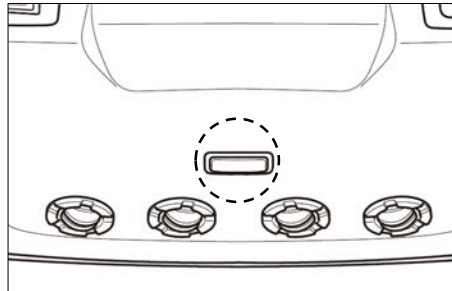

Push the button to light on.
And push it again to light off.

► **A/C, HEATER SYSTEM**

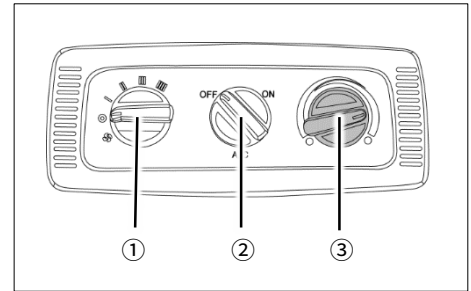

• **AIR VOLUME CONTROL**

Set volume of blower between 0 to 4.

• **A/C ON/OFF**

Turn on or off A/C system.

• **TEMPERATURE CONTROL**

Set temperature of A/C or heater.

Turn clockwise : Warmer

Turn counter-clockwise : Cooler

To operate the air conditioner, the blower must be on.

The blower speed temperature control and all vents must be adjusted to obtain the best cooling for the ambient

C



temperature and dust conditions.

Under normal operating conditions, and the windows and doors closed, temperatures in the cab of 6°C to 15°C (10°F to 25°F) less than the ambient temperature will occur.

When operating the air conditioner system, the moisture level is decreased.

IMPORTANT

- During cold weather with ambient temperature above 0°C (32°F) operate the air conditioner at least once per month, for a period of 10 to 15 minutes. This will lubricate the seals to prevent them becoming brittle and help prevent the loss of refrigerant from the system.
- The system is equipped with an environmentally safe refrigerant, R134a. Never recharge the air conditioning system with refrigerant other than R134a as this will result in loss of cooling and permanent damage to all air conditioning components.

• HEATING SYSTEM

The heater is switched on and adjusted by rotating the control knob at the roof console, then switching on the blower and setting the selector at the preferred speed.

To warm the cab up quickly, the knob should be rotated fully clockwise and the blower set to speed 4.

The screen is demisted or defrosted by air directed through a slot vent. For defrost or fast demist, all other vents should be closed off.

IMPORTANT

- Ventilation is provided by a single blower unit serving both the heating system and the air conditioning system. After reaching the desired temperature adjust the system to suit your needs.
- For ideal system operation, the engine must run at 1000 rpm.

► VENTILATION

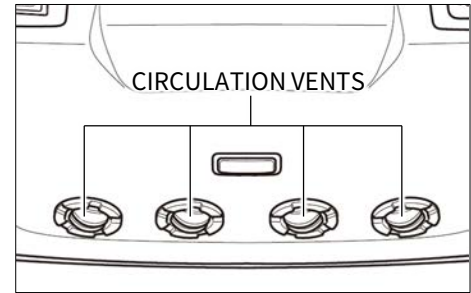

The ventilation unit is housed in the cab ceiling. To switch it on and adjust it, turn the electrical fan switch to the desired speed.

The cab becomes slightly pressurized when the ventilation system is in operation, so that the fresh air can enter only by way of the filter installed in the rear section of the cab roof.

The fan switch can be operated only after the ignition key is inserted.

The air flow can be regulated and directed by suitable positioning the air vents.

Air can be taken in fresh from outside or recirculated from within the cab by way of the relative side inlets.

► **RE-CIRCULATION INLETS FULLY CLOSED**

Air is taken in entirely from outside the cab through the rear grille and filtered through a paper element positioned behind the grille.

It is very important that the air vents never be completely closed so as to allow for a steady air flow.

To obtain a greater pressurization inside the cab, it is necessary to take the air from the outside, therefore the inside air recirculating grille should be fully closed.

 **CAUTION**

- Before starting the engine, make sure the system is off. (by turning off the ventilation fan) so as not to overload the battery.
After the system at full power for a long period of time, never turn it off suddenly but let it first idle for about 20 seconds.

► **AIR CONDITIONING SYSTEM**

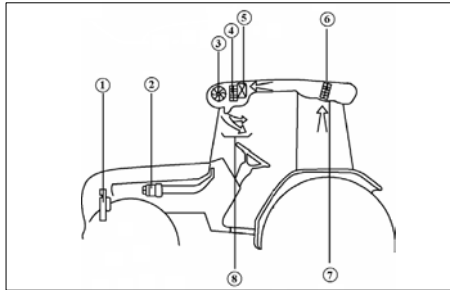

1. ALTERNATOR	5. EVAPORATOR
2. COMPRESSOR	6. AIR FILTER
3. SPEED FAN	7. RECIRCULATION INLETS
4. ELECTRIC RESISTANCE	8. AIR VENTS

The system is designed to ensure optimum temperature inside the cab and maximum comfort and safety for the operator.

However, it is advisable to consult our specialized workshops whenever repairs or adjustments need to be performed.

Do not approach the system with open flames, as any escape from the circuit may produce a lethal gas.

► **COMPRESSOR BELT ADJUSTMENT**

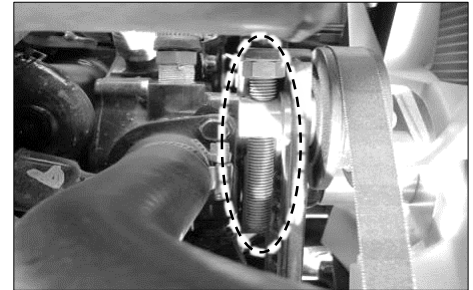

Check the compressor belt tension regularly and adjust if required. The correct tension is if the center of the belt is pushed with a finger it moves in approx. 10mm (0.39 inch) as shown in the picture.

To adjust the belt, loosen or tighten the nut as shown in the picture.



► ROOF HATCH

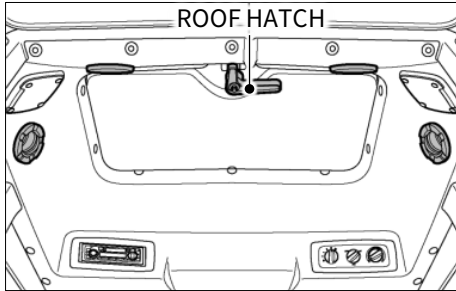

- **VENTILATION:**
push the latch towards the front of the tractor and then push the hatch up.
- **EMERGENCY EXIT:**
Push firmly upwards to release the support struts from the lower retainer clips.

► CABIN AIR INTAKE FILTER

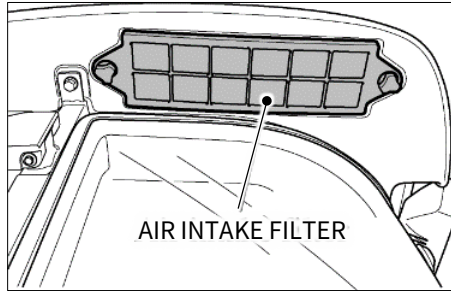

The paper filter is not suitable for the treatment of pesticides and so must be replaced by an active carbon filter available optionally.

Once the pesticide treatment is finished, it is necessary to once again replace the active carbon filter with the paper filter, since this is the only type suited for filtering foreign particles from the air. Optional active carbon filter is informed to parts catalogue.

CAUTION

- Cabin air filters remove dust in the air, but are not capable of removing chemicals used in spraying crops or in weed control. Many chemicals used for these purposes are toxic when improperly used, and can be hazardous to operators and others in the area. Follow the instructions of manufacturers of both the equipment and the chemicals regarding prohibition of dust or spray, personal hygiene practices, and other precautions noted by the manufacturers.

► **AUDIO SYSTEM**

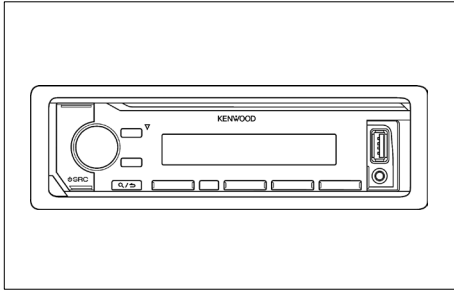

Audio system with FM/AM radio, AUX input and Bluetooth connection. For more detailed specification and instruction, refer to the manufacture’s manual or JVC KENWOOD website.

► **CUP HOLDER, POWER SOCKET**

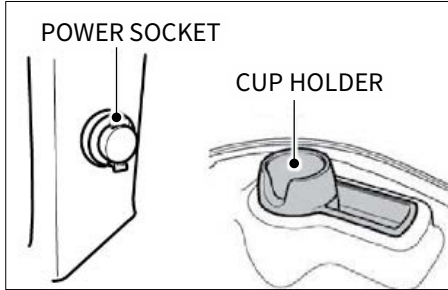

Put the bottles or personal belongings on cup holder.

Power socket is installed for electric devices.

► **CHECKING AIR CONDITION SYSTEM**

TYPE	CAPACITY
R134a	0.55kg (1.21lbs)

- ① Economic friendly refrigerant :
The presence of air and water in the system could jeopardize its efficiency.
The air is uselessly compressed by the compressor and no cooling effect is produced.
The moisture has a tendency rise to obstructions which prevent the cooling efficiency.
- ② Check belt tension ; when finger pressure is applied to the mid-point between both pulleys.
- ③ Condenser fins must always be duly clean using water or an air set.

• **CHECK THE REFRIGERANT CHARGE**

- a. Run the engine at 1500rpm.
- b. Set the air conditioning system in the coldest for 5 minutes.

C



▶ CHECK REFRIGERANT CHARGE

• CHECK REFRIGERANT CHARGE

- a. Run the engine at 1500rpm.
- b. Set the air conditioning system in the coldest for 5 minutes.

CAUTION

- If the air conditioning system is operated without being charged, The lubrication in the compressor can cause damage.

▶ HOW TO CHECK A/C SYSTEM WITH NEEDLE OF HIGH LOW GAUGE

To connect with manifold pressure gauge can find the cause of air conditioning system.

Because manifold pressure gauge is various sensibly (Ambient Temp. is based on 30~35°C)

Gauge pressure conversion

- $\text{lb/in}^2 = \text{PSI}$
- $1 \text{ kg/cm}^2 = 14.22 \text{ lb/in}^2$
(Ex) 200 PSI = 14 kgf/cm^2

CAUTION

- Operating E/G RPM 1500~2000 is must, and so to that you can check the correct cause and air conditioning.
(In case below the figure of indicated pressure gauge has some clearance, confirm with approximate indicated needle data.)

► DIAGNOSING MALFUNCTIONS OF A/C

	SYMPTOM	CONDITION	CAUSE	REMEDY
COMPRESSOR	Abnormal sound	<ul style="list-style-type: none"> Inlet / Outlet sound 	<ul style="list-style-type: none"> Insufficient lubrication Belt tension release Release the bracket 	<ul style="list-style-type: none"> Replenish Adjust Tighten the bolts
	Abnormal revolution	<ul style="list-style-type: none"> Inlet cause Outlet cause 	<ul style="list-style-type: none"> Damaged parts Insufficient lubrication Belt tension released 	<ul style="list-style-type: none"> Check, replace Replenish Adjust
	Refrigerant or oil leakage	<ul style="list-style-type: none"> Refrigerant or oil leakage 	<ul style="list-style-type: none"> Sealing washer damaged Head bolt released D-ring damaged 	<ul style="list-style-type: none"> Replace Tighten the bolts Replace
	Excessive pressure	<ul style="list-style-type: none"> Low, high pressure 	<ul style="list-style-type: none"> Insufficient refrigerant Compressor 	<ul style="list-style-type: none"> Adjust Replace
MOTOR	Weak from pressure or don't work	<ul style="list-style-type: none"> Motor is normal Motor is abnormal Air leakage 	<ul style="list-style-type: none"> Air inlet clogged Evaporator freezing Ventilator switch damaged Compressor Motor failure Wire cut Duct leakage 	<ul style="list-style-type: none"> Remove Controlling minimum pressure Replace the switch Replace Replace Replace Check, tighten
	Unable to control the fan	<ul style="list-style-type: none"> Motor 	<ul style="list-style-type: none"> Air volume control switch failure Motor failure 	<ul style="list-style-type: none"> Check, tighten Replace
	Noise	<ul style="list-style-type: none"> Regular or irregular noise 	<ul style="list-style-type: none"> Interference with pulley 	<ul style="list-style-type: none"> Control compressor direction
CLUTCH	Disengage	<ul style="list-style-type: none"> Engaged sometimes Engaged to push with hand No defect wire 	<ul style="list-style-type: none"> Wire defect Clutch gap large Low voltage Malfunction 	<ul style="list-style-type: none"> Check wire Adjust Check battery Replace
	Slip	<ul style="list-style-type: none"> Slip during rotation 	<ul style="list-style-type: none"> Low voltage Oil stick at clutch Malfunction 	<ul style="list-style-type: none"> Check battery Clean Replace

C



OPERATION

1. START & STOP OF ENGINE D - 2
2. OPERATING TRACTOR D - 4
3. OPERATION OF PTO D - 7
4. OPERATION OF DPF D - 9
5. IMPLEMENTS D - 10
6. TOWING THE TRACTOR D - 11
7. CHECKS DURING DRIVING D - 13
8. WORK PROCEDURES D - 15
9. OPERATION TIPS D - 21



1. START & STOP OF ENGINE

▶ HOW TO START ENGINE

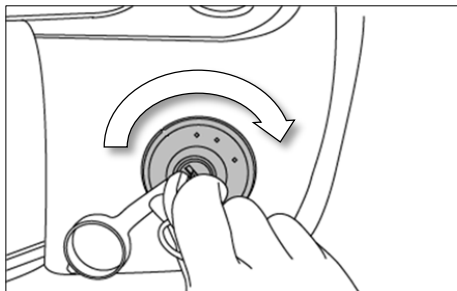

1. Make sure that there is no obstacle around the tractor.
2. Seat on driver's seat and confirm that parking brake is applied.
3. Check that each shift lever and PTO switch are in the neutral position.
4. Insert the key into key switch and turn it to 「ON」 position.
Check that warning lights are working and come off.
5. Turn the key switch to the 「START」 position.
When engine is started, release the switch.
6. Ensure that all warning lamps go off.

⚠ IMPORTANT

- Never turn the key to 「start」 position while engine is running as this can cause serious damage to starter and engine flywheel.
- Avoiding running the start motor over 10 second.
It consumes lots of current.
- If engine cannot be started within 10 second, wait for 30 second and try it again.
- Especially in cold weather, always allow the tractor to idle for a while to warm up and build up for a while to warm up and build up sufficient oil pressure to ensure normal operating temperature for longer engine life.

⚠ WARNING

- Never start engine by connecting start motor terminal or safety switch directly.
The tractor may move suddenly and cause an accident.

▶ PRINCIPLE OF AUTO PREHEATING SYSTEM

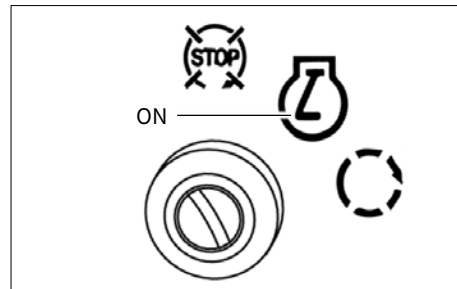

When key switch is in 「ON」 position, engine is automatically preheated as necessary.

Glow lamp is on as well.

As soon as preheating operation is completed, the lamp also goes off.

Engine can be started while the preheating operation is in progress.

▶ **STOPPING ENGINE**

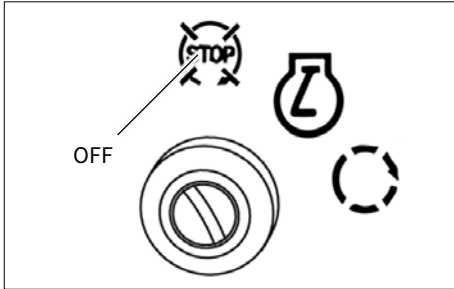

1. Idle engine before stopping it.
2. Turn key switch to 「OFF」 position.
3. Remove key from the switch.

▶ **ENGINE IDLING**

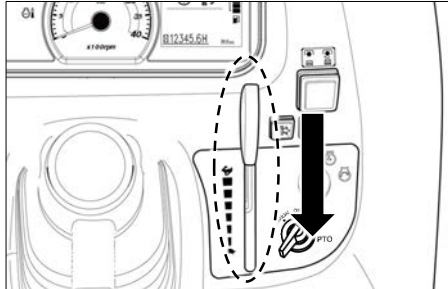

After starting engine, idle engine for 5~10 minute so that oil is delivered to each part of engine.

▶ **IDLING IN COLD WEATHER**

Hydraulic oil in this vehicle is also used as transmission fluid.

If the temperature drops in winter so oil gets cold, its viscosity rises and the hydraulic pump cannot suck oil in, causing malfunction.

Make sure to idle the engine in winter according to the following instructions.

TEMPERATURE	TIME
32°F or higher (0°C or higher)	more than 10 min.
32°F ~ 14°F (- 0°C ~ - 10°C)	10 ~ 20 min.
14°F ~ - 4°F (- 10°C ~ -20°C)	20 ~ 30 min.
- 4°F or less (- 20°C or less)	more than 30 min.

 **WARNING**

- Proper ventilation is needed when engine idling is performed indoors.

D



2. OPERATING TRACTOR

▶ STARTING OFF

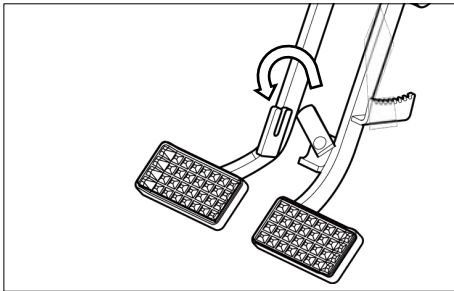

1. Confirm that left and right brake pedals are interlocked when two brake pedals are installed. Make sure to interlock left and right brake pedals unless working in a field.
2. Lift an implement.
3. Place main and sub shift lever into the desired position.
4. Depress brake pedal to release parking brake.
5. Use throttle lever or pedal to increase engine speed.

▶ SHIFTING AND DRIVING

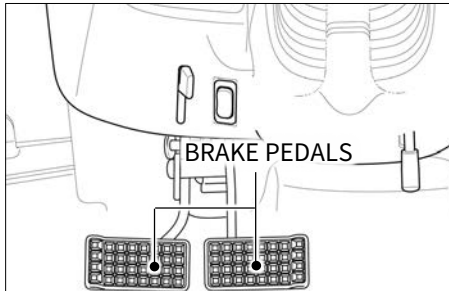

To shift during driving, depress the brake pedal to stop the vehicle in advance.

WARNING

- The driving speed in the reverse direction is almost the same to the speed in the forward direction. Make sure to check the surroundings carefully when driving backward.
- Especially, never drive backwards with the sub shift lever in the position high speed. The driving speed becomes faster and it can cause an accident.
- Connect the left and right brake pedals when it is about to drive when two brake pedals are installed.

▶ TURNING IN FIELD

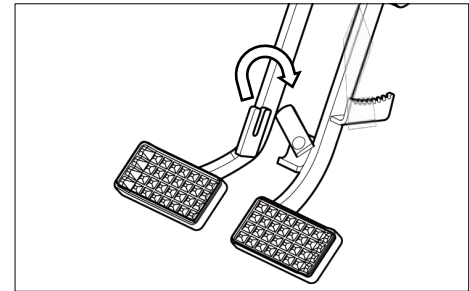

When two brake pedals are installed.

1. To turn in a field, release hook for left and right brake pedals.
2. Turn steering wheel and depress brake pedal for desired direction.
3. While turning, keep engine speed low and turn slowly.

When single brake pedal is installed.

Turn steering wheel to desired direction.

WARNING

- Avoid turning at a high speed. The tractor can fall on its side.
- When the tractor is installed with an implement, its overall length becomes large. Be extra care with other people and objects around when turning.

► **PARKING THE TRACTOR**

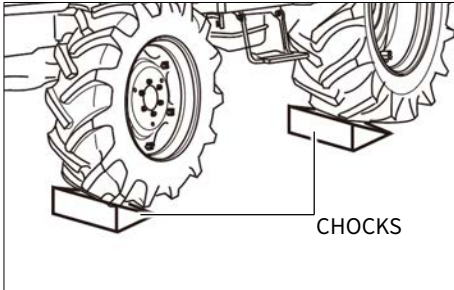

1. Stop tractor completely in level ground.
2. If an implement is attached to vehicle, lower it.
3. Set levers in neutral position.
4. Apply parking brake.
5. Remove key from key switch.

 **WARNING**

- After parking, make sure to apply the parking brake.
- Avoid parking on a slope if possible. If it is absolutely necessary to park on a slope, chock the rear wheels.

► **START ON STEEP SLOPE**

1. Depress the brake pedals.
2. Place sub shift lever in the low speed position.
3. Set engine at the mid speed with the throttle lever.
4. Depress the throttle pedal or use throttle lever to increase engine revolution.
5. Release the brake pedal at the same time.

► **TIPS FOR DRIVING ON SLOPE**

1. Set range shift lever in low speed position on a slope to prevent engine from stopping.
2. Keep driving speed low on a downhill road.
3. Do not set sub shift lever in neutral position on a downhill road.

 **IMPORTANT**

- When the needle on the coolant temperature gauge is pointing at 「H」 or coolant lamp comes on, engine is overheated. If running the engine under this condition continuously, the engine parts can be severely damaged. Make sure to take an appropriate action immediately.

 **WARNING**

- On a downhill road, use the engine brake. Otherwise, it can cause an accident.



► CAUTIONS FOR DRIVING INTO OR OUT OF FIELD

1. Check that left and right brake pedals are connected.
2. It is dangerous to drive into/out of a field if the field is deep from its bank. Use ramps.
3. Move in the perpendicular direction to the bank.
4. When driving out of the field, lower the implement so that the front wheels cannot be lifted.
5. It is recommended to drive into a field backward to utilize full power.

WARNING

- Be careful to keep the tractor's balance when working on a slope. The tractor may become out of balance and roll over.
- It is very dangerous to ride a person as a front weight.

► LOADING TO OR UNLOAD FROM TRUCK

1. When loading the tractor onto a truck, drive backward.
2. Be extra careful when using ramps.
3. If the engine stops on ramps, depress the brake pedals immediately and release them slowly to move onto the ground. Then, start the engine again to climb the ramps again.

► CAUTIONS FOR DRIVING ON ROAD

1. When changing the direction on a road, use the turn signal lamp to inform other drivers.
2. Use the low beam when there is any vehicle coming on the other side at nighttime.
3. Check that the left and right brake pedals are connected.
4. Keep the work lamps off when driving at night.
5. Follow any applicable laws and keep safe driving.
6. Never let anyone ride the tractor, except yourself as a driver.

WARNING

- If driving on a road with an implement attached, the front side of the tractor tends to be lifted and vehicle may not be steered properly.

3. OPERATION OF PTO

Rear PTO is provided for variable utility. The engine will not start if PTO switch is ON position.

The engine will shut-off if the operator leaves the seat with parking brake released and PTO engaged.

PTO	PTO speed
REAR	540 / 1,000 RPM

⚠ WARNING

- To avoid damage of transmission and implement, do not engage PTO with the engine running at high speed.
- Do not operate any implement at a high speed than is specified for it.
- When making adjustments to the implement, stop the engine to avoid serious injury.
- When leaving the tractor stop the engine and remove the key. Apply parking brake.

▶ **OPERATING PTO**

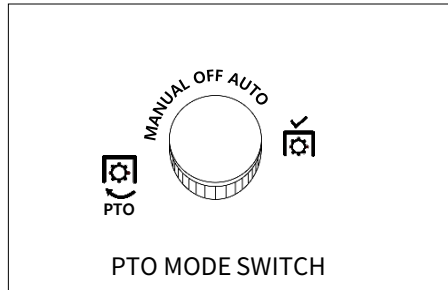
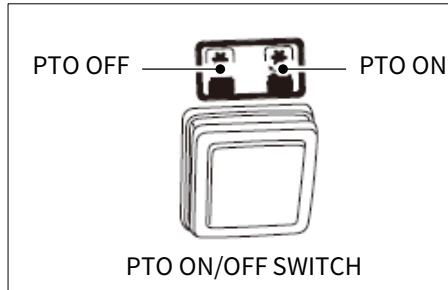

Follow next steps to use PTO.

1. Decrease engine speed to near idle.
2. Change PTO mode switch and PTO shift lever to desired positions.
3. Turn on the PTO switch.
4. Increase engine speed to desired speed.

▶ **PTO MONITOR LAMP**



PTO monitor lamp indicates the state of the PTO shaft.

- **If the monitor glows:**
The PTO is rotating.
- **If the monitor is off:**
The PTO is off.
- **If the monitor blinks:**
The PTO is presently stationary but will instantly start rotating of the implements lowered.

D



► PTO ROTATION TABLE

N/A : not applicable

PTO ON/OFF SWITCH	PTO MODE SWITCH	PTO SHIFT LEVER	POSITION LEVER	PTO MONITOR LAMP	PTO SHAFT ROTATING
N/A		NEUTRAL	N/A	OFF	OFF
OFF	N/A			OFF	OFF
N/A	OFF	N/A		OFF	OFF
ON	MANUAL	540 / 1,000	N/A	GLOW	ON
ON	AUTO	540 / 1,000	RAISED	BLINK	OFF
ON	AUTO	540 / 1,000	LOWERED	GLOW	ON

- From the table above we learn about the safety features of the PTO. When the monitor on the dash panel is blinking it indicates to the operator that the PTO is in the on position but temporarily not rotating because the implement is lifted off the ground or both. The PTO will start rotating instantaneously when the implement is lowered to the ground.
- The operator must use this blinking signal to clear the area around the tractor off bystanders/onlookers as the rotating blades of certain implements can accidentally cause injuries to the persons standing near the tractor.
- The stopping of the PTO when the implement is lifted off the ground with the position control prevents the damage to the implement or the PTO shaft.

WARNING

- When the PTO mode switch is in manual position the PTO does not stop rotating. If working on hard soils, pavements with a rotary implement the PTO ON/OFF switch must be put to the OFF position to stop the PTO from rotating. If this is not done, the rotating blades of the implement will push on the hard ground below and in turn push the tractor toward causing accident which can lead to serious injuries or death.
- Extra precaution must be taken to clear the area of bystanders/onlookers when using PTO driven implements. The rotating blades of the implements can cause serious injuries on contact. The warning that is indicated by the blinking PTO monitor is to make the operator aware that the PTO is in on position and will instantly start rotating if the implement is lowered or both.
- In no case the specified rotating speeds indicated by the implement manufacturer be crossed as the same can lead to serious damage to the tractor/equipment and can lead to serious injuries to persons around.

4. OPERATION OF DPF

▶ AUTOMATIC REGENERATION

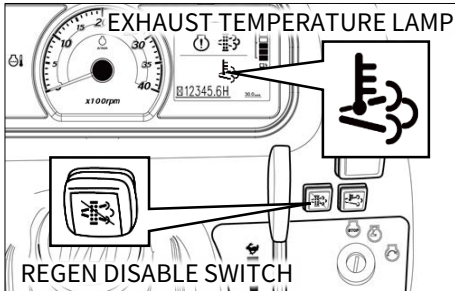

The regeneration process is automatically being performed when the exhaust temperature lamp comes on during work.

Press RegenDisable switch to stop automatic regeneration.

DANGER

- Run the system in a well-ventilated area to secure your safety. If running the system in a poorly-ventilated area, such as greenhouses, it can lead to gas poisoning.
- Never move the vehicle to another place during regeneration process. Sudden movement can result in an accident.

▶ REGENERATION ACTIVATE

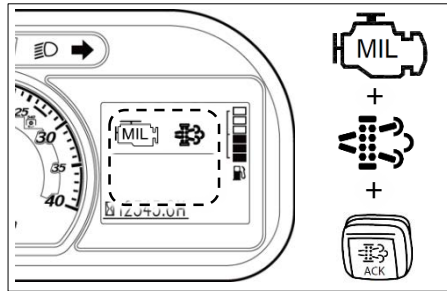

It is necessary to activate the regeneration function manually if the engine warning lamp, regeneration request lamp and RegenReq. switch are illuminated during work. Follow next steps to activate regeneration function.

1. Stop working and park the vehicle on level ground or in a safe place.
2. Before starting regeneration, apply the parking brake and idle the engine. Then RegenReq. switch blinks. However, regeneration process is not performed if regeneration activation conditions are not satisfied.
3. Press and hold RegenReq. switch for 3 seconds and release it.

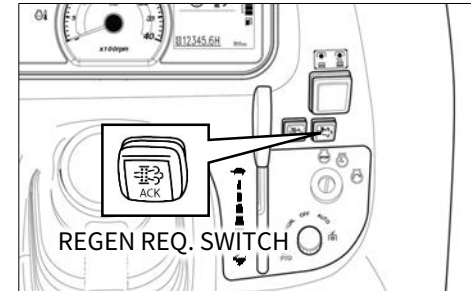

4. Then, the RegenReq. switch and exhaust temperature lamp are illuminated and the engine speed is increased up to 2,200 RPM to perform the regeneration process for approx. 30 minutes.
5. As soon as the regeneration process is completed, all the lamps are turned off.

IMPORTANT

- Engine warning lamp comes on when DPF inlet temperature sensor system doesn't function properly. Also engine warning lamp and NCD lamp come on when EGR sensor or air temperature sensor don't work properly.

D



5. IMPLEMENTS

► CONNECTION TO IMPLEMENTS

1. Make sure to stop the engine before connecting the implements.
 2. Move the double acting valve lever forward and backward for 4 to 5 times to release pressure in the hydraulic line of tractor. Otherwise, it is hard to connect the couplers, and hydraulic fluid can be sprayed from the line and get in to your eyes while connecting them.
 3. Remove any foreign material around male and female couplers. If foreign material enters the hydraulic components, it can lead to malfunction of the system.
 4. Open dust-proof cover of female coupler of the tractor and insert the male coupler of the implement. A clicking sound is heard when the couplers are engaged.
 5. Pull the hydraulic hose of the implement to check that the couplers are properly connected.
- ※ **Hydraulic control valves may not exist depending on tractor model.**

► DISCONNECTION FROM IMPLEMENTS

1. Make sure to stop the engine before disconnecting it.
2. Release any residual pressure in the hydraulic hoses of the implement and tractor by operating the double acting valve lever 4 to 5 times.
3. Remove any foreign material around the couplers.
4. Keep the implement balanced by removing any load applied (lowering it onto the ground, for example).
If disconnecting the hose while outer load is applied to the implement, it is hard to connect the implement in the future.
5. Remove the male coupler by pushing the female coupler boss of the tractor backward.
6. Close the dust-proof cover of the female coupler of the tractor. Wrap the male coupler of the implement with a plastic bag to prevent contamination.

► MOUNTING IMPLEMENTS

If the PTO is used, remove the safety cover off the PTO shaft.
Adjust the yoke rod on the lower links to suit the implement in use.
Attach the left lower link, then attach the right lower link using the adjusting handle on the leveling box if required.
Attach the top link.
Attach PTO shaft to the tractor if used, making sure that it is locked in place.
Adjust the check chains to suit the implement and tighten the locknuts.

WARNING

- Never connect or disconnect the implement hydraulic hose while the pressure in it is not released or the engine is running.
It's hard to connect and disconnect the hose and hydraulic fluid can be sprayed from the hose, and get into your eyes or skin.
- stop engine and wear protective glasses and gloves before work.

6. TOWING THE TRACTOR

► TOWING THE TRACTOR

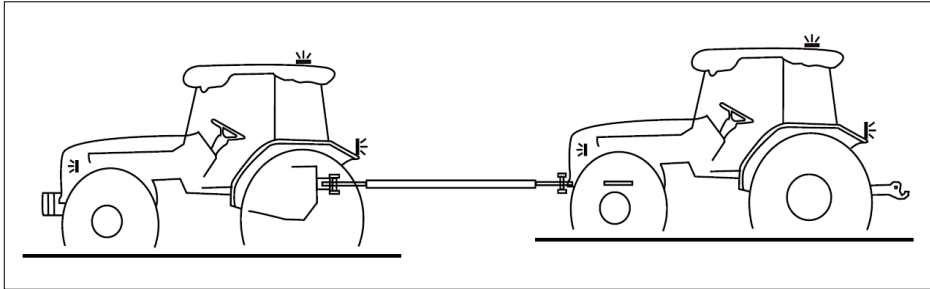

The tractor can be towed only for short distances, such as, for example, from inside to outside a building. A broken down tractor should be towed for the minimum indispensable distance to remove it from potentially dangerous conditions. Observe all legal provisions as envisaged in the highway code relative to national legislation regarding towing manoeuvres.

DANGER

- NEVER permit other persons to access the tractor operator position during towing.

WARNING

- We recommend transporting the tractor on a low loader in the case of longer transport distances. Comply with the maximum width and height regulations for road transport. Check that the loader is suitable for the weight of the tractor to be transported.

CAUTION

- An operator must always be at the tractor's controls when the tractor is being towed.

► TOWING WITH ENGINE RUNNING

Towing with the engine running can be performed if forced gearbox lubrication is ensured:

- Engine speed between 1200 - 1300 rpm.
- Maximum towing speed 8 km/h
- Maximum towing distance 1 km

For towing the tractor use only a standard bar applied to the front towing hitch approved by the manufacturer.

Make sure to use the correct pin for the towing hitch and that it is secured with its locking pin.

Clean all lights required for road use, front and rear, and make sure they are in working order.

Before starting towing check the following conditions:

- Unhitch any implement from the tractor;
- Lock the two brake pedals together with the connecting latch;
- Disengage the power take-off and differential locks;



- Set the shuttle control lever and gear lever to neutral;
 - Move the range lever to the 「FAST」 position;
 - Move the creeper lever to neutral;
 - Display the SMV (Slow Moving Vehicle) sign and turn on the rotating beacon and hazard lights
- Travel speed must always be such as to allow complete control and stability of the tractor in all conditions.

DANGER

- Never attempt to tow the tractor with ropes (including steel ropes) because rope breakage can cause serious injury.

WARNING

- Switch on the hazard warning lights and revolving warning lights. Affix suitable notices indicating that the tractor is being towed. Observe and follow the relevant national regulations. Observe local safety regulations.

► TOWING WITH ENGINE OFF

With engine stopped and with forced gearbox lubrication system inoperative the tractor should not be towed except when safety is at risk.

IMPORTANT

- With engine stopped and with forced gearbox lubrication system inoperative the tractor can be transferred to a service center only when loaded onto a transporter.

During road transfers observe the following instructions:

- Wait until traffic thins before joining the road. Exert caution in the proximity of unregulated intersections. Slow down until you have a clear view in both directions.
- Keep in your lane and drive as close as possible to the kerb.
- If a tailback builds up behind you pull into a lay-by as soon as possible to allow the traffic to pass
- When stopping the tractor (in any circumstances) apply the parking brake.

7. CHECKS DURING DRIVING

► CHECK DURING DRIVING

Constantly monitor the warning lamps on the monitor panel and if any comes on, stop the tractor to determine the cause.

► OIL PRESSURE

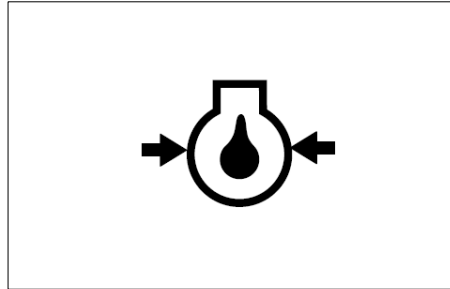

If the oil pressure lamp comes on check the oil level first of all.

If the oil level is OK, ask a qualified dealer to check the reason for the light coming on.

► BATTERY CHARGING

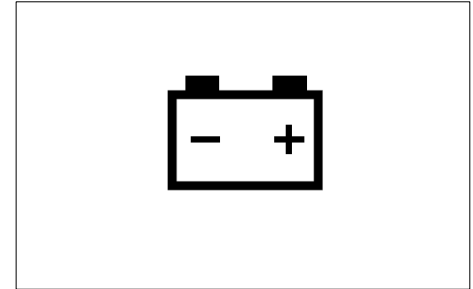

If the alternator warning lamp comes on check all connections and ensure that the fan belt is not broken.

If all connections and the fan belt are intact consult your dealer to determine the cause of the problem.

D



► FUEL GAUGE

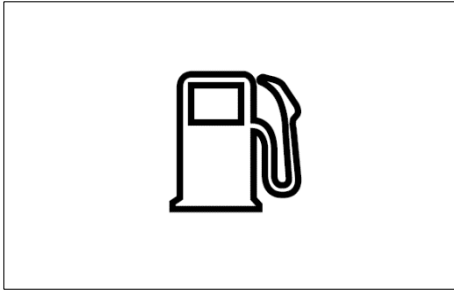

To avoid excessive condensation in the fuel tank refill at the end of each day's work and ensure during the day that it does not drop to a low level where the fuel system will require bleeding to expel air in the system after refilling the tank.

► COOLANT TEMPERATURE

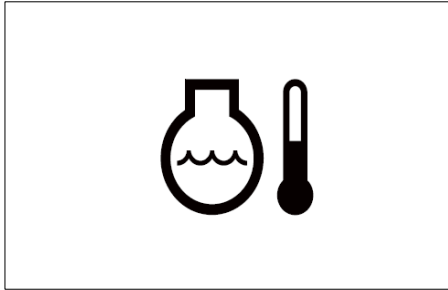

If the coolant warning lamp comes on, the engine is over-heated.

Stop the tractor and check followings:

- Radiator coolant
- Radiator fin for clogging
- Fan belt for looseness

If necessary, have your tractor checked by workshop.



DANGER

- Allow the engine to cool down before opening radiator cap as serious burns may result due to hot steam and boiling water.

► TRAILER SOCKET

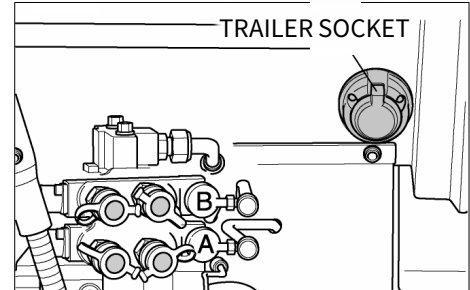

The socket is ready to operate the electrical systems of implements, trailer lighting, warning lamps and etc. (seven terminal electrical socket type)



WARNING

- When traveling on public or farm roads, connect both brake pedals and allow for the weight of any mounted implement to ensure that unit is not unbalanced.
- Where fitted use the hazard lights provided.
- Strictly follow the local traffic regulations.
- When operating near others with an implement attached take particular care to allow for the width of the implement and avoid accidents.

8. WORK PROCEDURES

► PRECAUTIONS FOR HANDLING IMPLEMENTS

1. When driving the tractor to attach or detach an implement, make sure that there is no one in between or around the tractor and implement.
2. Install and remove the implement only on safe and level ground.
3. When installing a heavy implement, install weight on the front to keep balance.
4. When adjusting an implement, apply the parking brake, stop the engine and set the PTO switch in the OFF position in advance.
5. To tow anything, use the towing hitch only.
6. When working with a front loader, install an implement to the back to keep balance (if necessary).

WARNING

- Read instructions on warning decals on each implement thoroughly before work.
- To avoid an injury due to mishandling of an implement, read the user's manual of the implement thoroughly and work safely and precisely with caution.
- Installation of an improper implement can lead to an injury. Install only implements specified by the manufacturer.

► GENERAL IMPLEMENT

<Safety precautions for rotavator>

Never remove the safety cover of the rotavator.

Do not remove the PTO shaft cover and safety cover on the universal joint.

When adjusting each part, disengage the PTO and stop the engine in advance.

When driving on a road, keep the PTO disengaged.

Also, keep the rotavator lowered on a road as long as it does not hit the ground.

For the universal joint, its inner shaft and outer shaft should be overlapped at least 15 cm.

Check that the universal joint is firmly fixed to the tractor and rotavator shaft.

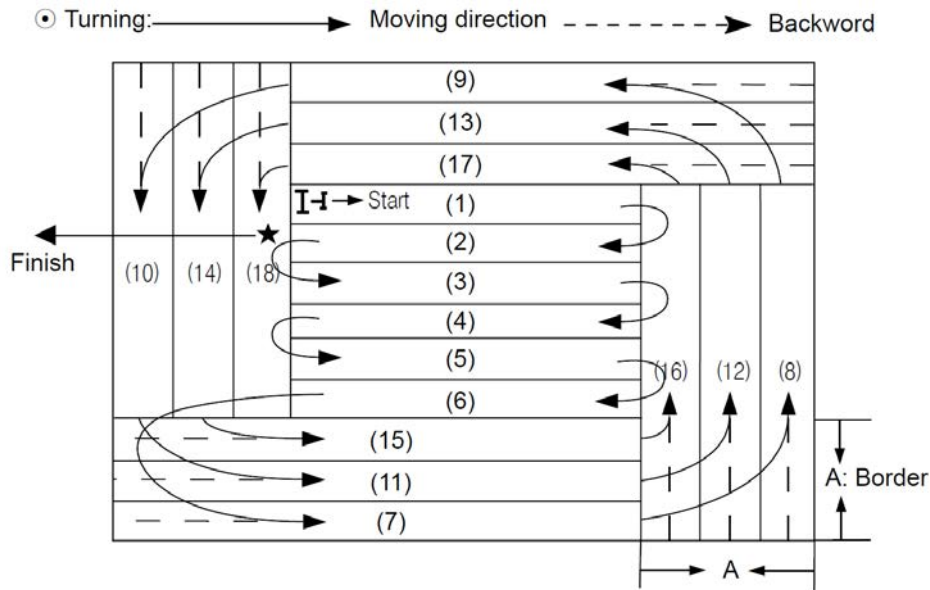

1. Sequential returning plowing pattern

- This pattern can be useful in a well-planned field in a good condition.
- The border shown in the figure is the effective plowing width of the rotavator and should be set a little narrower than three times of one plowing width.
- The starting point is the ending point.
- Plow in a sequential pattern from (1) to (6) and in a circular pattern from (7) to (18).
- When driving forward to plow, have the bank on the right side.
- Be careful not to press already plowed soil with the wheels.

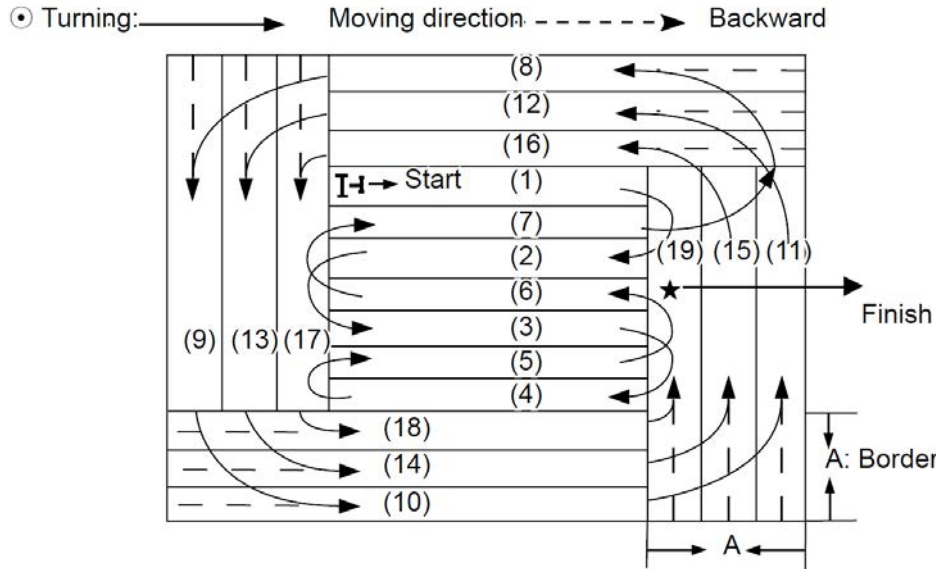

2. Alternating returning plowing pattern

- This pattern is useful for narrow or short fields or poorly planned fields in which are not easy to turn.
- In the figure, the plowing width for (1), (2), (3) and (4) should be overlapped with the one for (5), (6) and (7) for approx. 10 cm.
- For the sections (1) to (7), perform plowing in an alternating pattern. For the sections (8) to (19), plow in a circular pattern.
- Refer to the sequential returning pattern for other details.

D



⊙ Turning: —————→ Moving direction - - - - -→ Backward

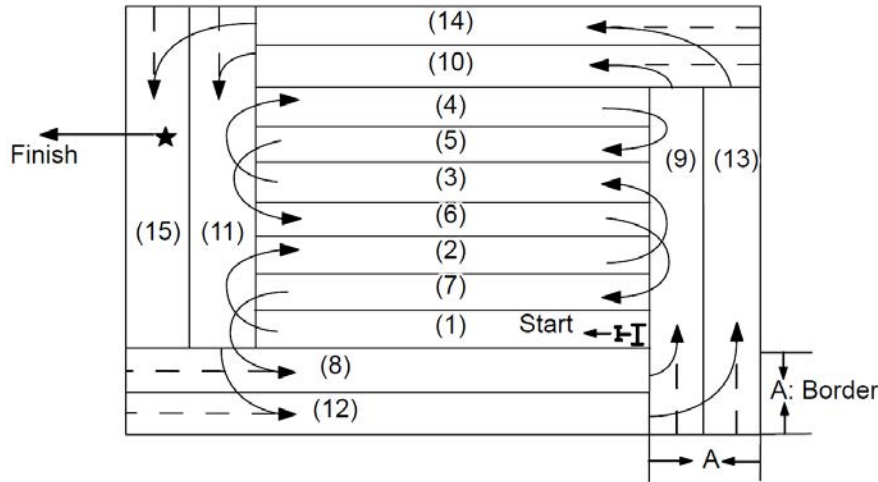

3. Land leveling pattern

- The land leveling work may be performed after crushing soil or not.
- The vehicle speed can be set faster when performing the land leveling work with soil crushed already.
- When working in a wet field, fill the field with a sufficient amount of water so that the trace of plowing cannot be seen.
- The border shown in the figure should be set a little narrower than two times of one plowing width.
- Refer to the alternating returning pattern for other details.

► **LOADER**

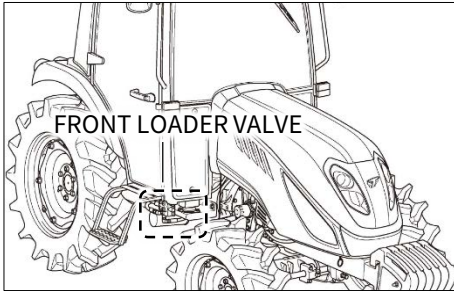

When installing for loader, the loader should be facing up, but a loader the left when not installed.

 **WARNING**

- When connecting the hydraulic pipes, set them according to the operating directions specified on the label attached to the side of the joystick lever.
- Abnormal operation of a loader can lead to an accident.

 **IMPORTANT**

- If it is hard to steer the tractor for plowing as the front wheels are lifted, install additional weight to the front. (if no loader is installed.)

► **FOR SAFE LOADER WORK**

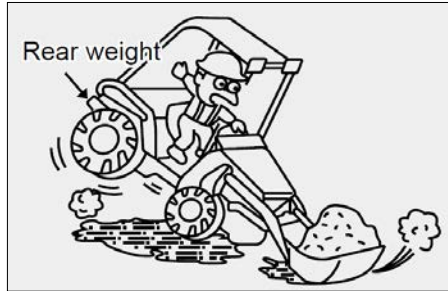

Keep the balance between the front and rear by installing a weight to the back of the tractor or attaching a weight or implement using the 3-point link.

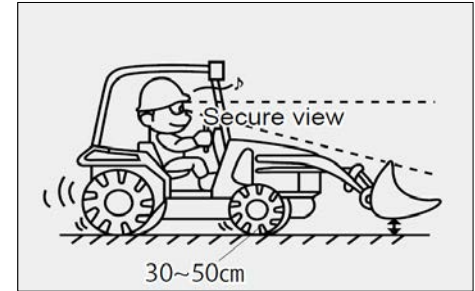

When transporting things with a loader, lower the loader and keep the driving speed slow.

Keep the loader 30 to 50 cm off the ground and the driving speed below 5 km/h.

When going onto a slope or unpaved area, lower the speed and drive with care.

D

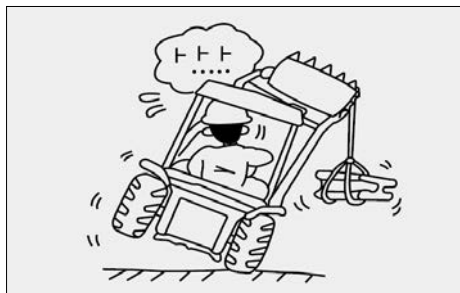

Do not lift anything only with one side of the tractor. If so, the tractor may fall on its side.

Make sure to distribute the load evenly.

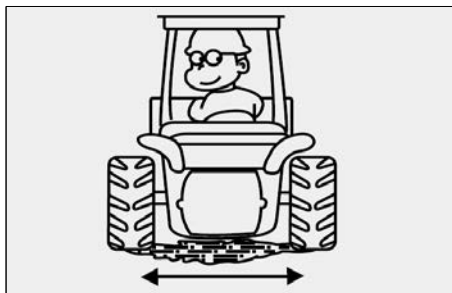

Keep the clearance between the rear wheels as large as possible for safety of the tractor.

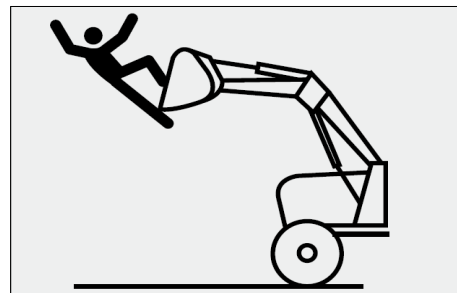

WARNING

- Do not let anyone ride a loader for work, such as spreading fertilizer. He/she may fall off the loader, leading to an injury or even death.
- Always lower the loader to the ground before leaving the tractor.

IMPORTANT

- This chapter only provides brief descriptions and instructions for a rotavator and loader. Therefore, for detailed operational instructions and other descriptions, refer to the user's manual of each implement.

9. OPERATION TIPS

To save fuel & oil in your tractor, following things should always be kept in mind.

► AIR CLEANING SYSTEM

1. Clean the air cleaner regularly so that dust does not settle down.
2. For every 50 hours & everyday in sandy/dusty conditions.
 - Clean the air cleaner filter element with compressed air.
 - If the rubber ring is cut or expanded then change it with an appropriate one.
Fix the rubber at the proper location & check for leakages if any.
 - If air is leaking through the hose connection, check & rectify other leakages, too.

IMPORTANT

- If air cleaning system is not properly maintained, it will lead to early wear of piston rings & sleeves. This will lead to problems like loss of engine power, excessive oil consumption fuel consumption.

► ENGINE

1. Put the engine oil on load after the engine is heated & the water temperature gauge indicates the needle to be in the green zone.
2. If excessive black smoke is visible, then the paper element of air cleaner, Fuel injection pump or nozzles should be checked.
3. Do not run the engine without load for more than 2 minutes. It is better to stop the engine rather than run it idle. This will help in saving of fuel.



► BRAKE

1. If the tractor has to be stopped for a long period, it is advisable to bring the transmission in neutral position.
2. Do not override the brake pedals.
3. While coming down from a slope, reduce the engine throttle & use low gear.
Do not depend only on the brakes for stoppage.

► OIL SYSTEM

1. Always use recommended grade of oil.
2. Everyday before starting the engine, check the oil level with a dipstick & refill between the minimum & maximum level.
3. Charge the engine oil.
Replace filter & O-ring, as & when required.

► LUBRICATING OIL

• GENERAL

Modern diesel engines place very high demands on the lubricating oil to be used. The specific engine performances which have increased constantly over the last few years lead to an increased thermal load on the lubricating oil. The lubricating oil is also more exposed to contamination due to reduced oil consumption and longer oil change intervals. For this reason it is necessary to observe requirements and recommendations described in this operating manual in order not to shorten the life of the engine. Lubricating oils always consist of a base oil and an additive package. The most important tasks of a lubricating oil (e.g. wear protection, corrosion protection, neutralization of acids from combustion products, prevention of coke and soot deposits on the engine parts) are assumed by the additives. The properties of the base oil are also decisive for the quality of the

product, e.g. with regard to thermal load capacity. In principle, all engine oils of the same specification can be mixed. However, mixing of engine oils should be avoided because the worst properties of the mixture are always dominant.

• VISCOSITY

The ambient temperature at the installation site or in the application area of the engine is decisive for choosing the right viscosity class. Too high a viscosity can lead to starting difficulties, too low a viscosity can endanger the lubrication effect and cause high lubricating oil consumption. The viscosity is classified according to SAE. Multipurpose lubricating oils should be used basically.

IMPORTANT

- The prescribed lubricating oil quality must be observed when selecting the viscosity class.

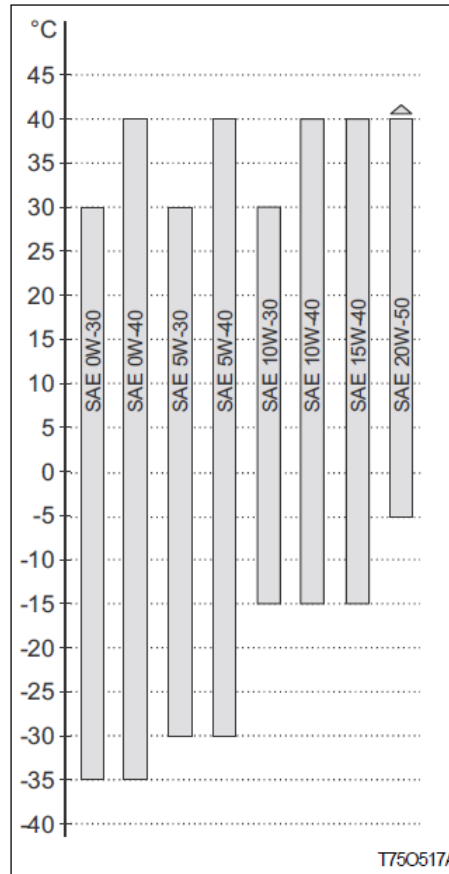

1. Always use filtered diesel for the fuel system.
2. At the end of the day's working, it is preferable to fill the diesel tank so that it may prevent condensation.
3. Change the filter, if the system gets choked.

Do not change both the filters at the same time.

If the above directives are not adhered to, the fuel injection pump & injection nozzle will lose its life early.

Also, it will lead to excessive black smoke & excessive diesel consumption.

※ Please refer to 「APPENDIX」 chapter for more details of diesel fuel.



► WINTER OPERATION WITH DIESEL FUEL

Special demands are placed on the cold behavior (temperature limit value of the filterability) for winter operation.

Suitable fuels are available at filling stations in winter.

At low ambient temperatures paraffin discharges can lead to blockages in the fuel system and cause operating faults.

IMPORTANT

- For engines with common rail injection, the mixing of petroleum and adding of extra low additives is not permissible.

► COOLING SYSTEM

1. Check the fan belt tension regularly. Adjust, if required.
2. Check the coolant level in the radiator fins always clean.
3. Replace the radiator cap with a genuine cap only, if required.
4. Do not remove the thermostat but replace with a new one, if required.
5. Do not change the radiator water often.

※ Please refer to 「APPENDIX」 chapter for more details of coolant.

► OTHERS

In liquid-cooled engines, the coolant must be conditioned and monitored, otherwise the engine could be damaged by:

- Corrosion
- Cavitation
- Freezing
- Overheating



MAINTENANCE

1. MAINTENANCE SCHEDULE · · · · · E – 2
2. OPENING COVERS · · · · · E – 4
3. CHECKS & SERVICING EACH PART · · · · · E – 5
4. GREASING EACH PART · · · · · E – 18
5. STORING THE TRACTOR · · · · · E – 19



MAINTENANCE

1. MAINTENANCE SCHEDULE

► PERIODICAL CHECK AND SERVICE TABLE

- Check or adjust each part only when engine is stopped.
- When any hot part should be serviced, wait until it is cooled down.

- : Check · Add · Adjust
- : Replace
- ★ : Replace at first time only
- △ : Clean

INSPECTION PART	TIME OF USE											YEAR		REMARK
	50	100	150	200	250	300	350	400	450	500	550	1	2	
ENGINE OIL LEVEL	CHECK ENGINE OIL LEVEL BEFORE WORK													
ENGINE OIL & FILTER	★					●						●	●	EVERY 250HR OR 1 YEAR
FUEL FILTER										●				
FULE HOSE & BAND										○			●	EVERY 2 YEAR
AIR CLEANER ELEMENT		△		△		△		△		●				EVERY 500HR
AIR CLEANER HOSE & BAND										○			●	EVERY 2 YEAR
INLET HOSE & BAND										○			●	EVERY 2 YEAR
COOLANT													●	EVERY 2 YEAR
COOLANT LEVEL	CHECK COOLANT LEVEL BEFORE WORK													CHECK BEFORE WORK
RADIATOR & RADIATOR NET	CLEAN RADIATOR & RADIATOR NET BEFORE WORK													CLEAN BEFORE WORK
RADIATOR HOSE & BAND										○			●	EVERY 2 YEAR
FAN BELT & A/C BELT					○					○				IF IT IS NEEDED
BATTERY		○		○		○		○		○				IF IT IS NEEDED

| Check or adjust each part only when engine is stopped.
| When any hot part should be serviced, wait until it is cooled down.

○ : Check · Add · Adjust ● : Replace
 ★ : Replace at first time only △ : Clean

	INSPECTION PART	TIME OF USAGE												REMARK	
		50	100	150	200	250	300	350	400	450	500	550	600		
C H A S S I S	TRANSMISSION FLUID	★										●		REPLACE EVERY 500 HOUR	
	HYDRAULIC OIL FILTER	★										●			
	FRONT AXLE OIL	★										●			
	TOE-IN	GET SERVICED BY WORKSHOP EVERY 300HR												2~6mm (0.078 in. ~ 0.236 in.)	
	GREASING EACH PART	ADD EVERY 50 HOUR, DAILY IF WORKING IN WET FIELD													
	BRAKE PEDAL PLAY	CHECK FREQUENTLY BEFORE DRIVING (CHECK SIMULTANEOUS OPERATION OF LEFT AND RIGHT BRAKE PEDALS)												PLAY : 30~40mm (1.18 in. ~ 1.57 in.)	
	TIGHTNESS OF FRONT & REAR WHEELS	CHECK FREQUENTLY BEFORE DRIVING													
	ADJUSTING THROTTLE SYSTEM						○							○	
	RUBBER HOSES					○						○			
	CHECKING ELECTRIC WIRING	○			○			○				○			EVERY YEAR

E



2. OPENING COVERS

▶ OPENING HOOD

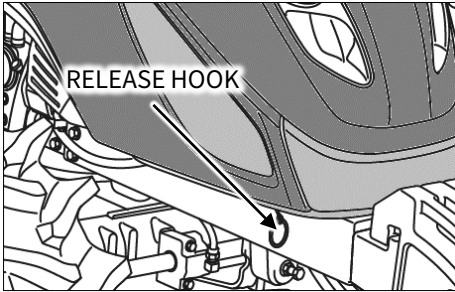

With the hood up, the hook release lever can be removed by pulling rearwards, having first detached the hood lamp wiring harness. Hood can be open by itself.

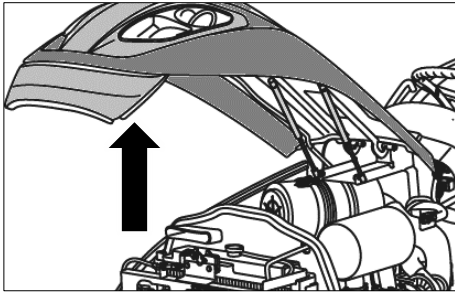

▶ OPENING SIDE COVER

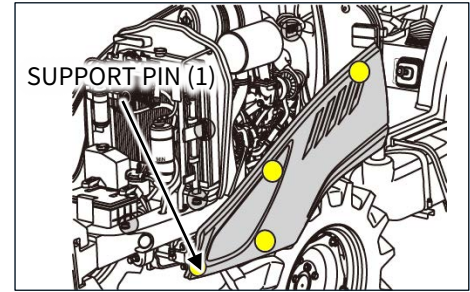

To open the side cover, following next steps.

1. grasp the side cover, pull the forward panel upward to separate from guide the support pin (1).
2. And pull the side panel forward again,

3. CHECKS & SERVICING EACH PART

▶ COOLANT CHECK

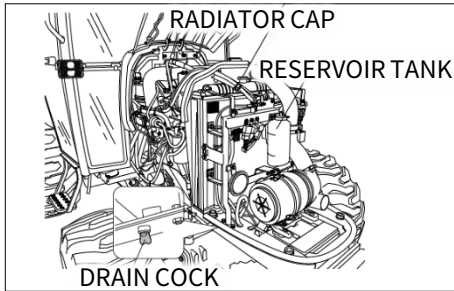

Remove the radiator cap and ensure that the coolant is up to the filler neck and that it is clean with the correct anti-freeze or anti corrosion inhibitor in it. If the coolant is a rusty color, drain the system completely and refill with the correct mixture of water and anti-freeze or corrosion inhibitor.

WARNING

- If coolant gets on your skin, it can irritate the skin and cause a skin condition. Make sure to clean your skin with soap and water or hand cleaner.
- Please refer to 「APPENDIX」 chapter for coolant specification and capacity.

▶ COOLANT CHANGE

Follow steps below to change coolant.

1. Remove the hose to drain the coolant.
2. Open the radiator cap at the same time.
3. To give a thorough clean run a hose into the radiator and flush it out.
4. Close the tap and refill the radiator with a coolant mixture of water and corrosion inhibitor or anti freeze.
5. Start the engine and allow it to run for approx. 5 minutes, check the water level again and top up if required.

CAUTION

- Do not remove the radiator cap on a hot engine.
- Serious burns, can result from the contents of pressurized, hot radiators.
- Allow the engine to cool down and then turn the cap slowly to ensure, that there is no excessive pressure in the radiator.
- Check coolant level after changing it.

▶ ANTI-FREEZE

If coolant freeze, the engine can be damaged.

Please ensure followings.

Clean the radiator before adding antifreeze.

Mixture ratio of antifreeze is different by manufactures and temperature.

Follow the guide of manufacture's manual.

Adding antifreeze in case of;

- If evaporated – Add water for reduced amount.
- If leaked – Add mixture of antifreeze and water with same mixture ratio.



► ENGINE OIL CHECK

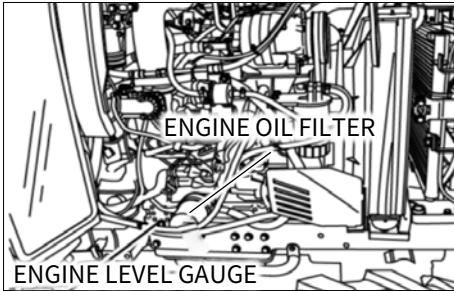

Follow the steps below to check engine oil.

1. Pull out the dipstick, wipe its tip and insert it again.
2. Check that oil level is between the upper and lower limits.
3. If insufficient, add more oil
But never exceed 100 hours of service interval.

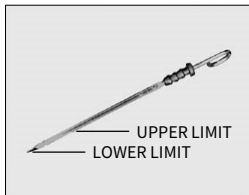

<DIP STICK>

► ENGINE OIL CHANGE

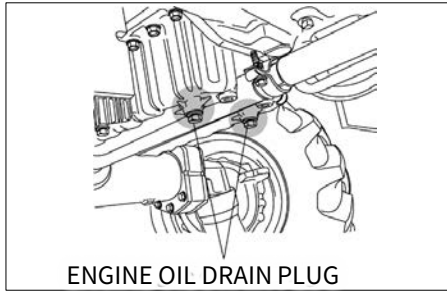

Follow the steps below to change engine oil.

1. Ensure that engine is cool enough not to get burnt.
2. Unscrew the drain plug on lower section of the engine to drain contaminated engine oil.
3. After draining engine oil, tighten the drain plug.
4. Remove the cap of engine oil, add specified amount of engine oil through engine oil filling hole.
Always change the engine oil filter when changing engine oil.

⚠ IMPORTANT

- Do not add engine oil over upper limit level.
- When trying to use new oil from a different manufacture or oil with different viscosity, drain used oil completely before adding new oil.
- Always use the same oil, as using different oils or specifications can cause damage.
- Dispose off the old oil as per local regulations.
- Please refer to 「APPENDIX」 chapter for engine oil specification and capacity.

⚠ CAUTION

- If engine oil gets on your skin, it can irritate the skin and cause a skin condition.
Make sure to clean your skin with soap and water or hand cleaner.
- Make sure to cool down the engine sufficiently before draining oil.
Oil is very hot and can cause a burn if changing oil right after the engine is stopped.
- Check engine oil level after filling it.

▶ TRANSMISSION OIL CHECK

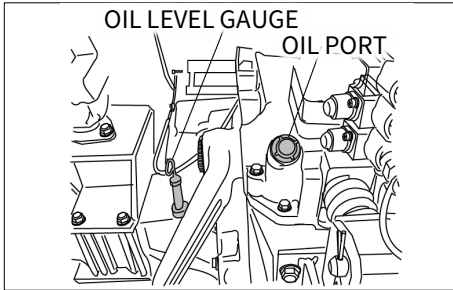

Follow the steps below to check transmission oil.

1. Ensure the engine is stopped.
2. Check transmission oil level with dip stick on top of transmission in rear of the seat.
3. If insufficient, add transmission oil through oil port.

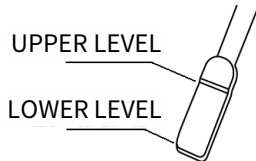

▶ TRANSMISSION OIL CHANGE

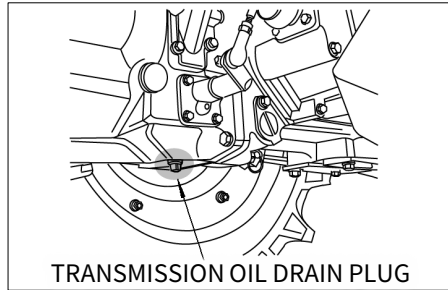

Follow the steps below to change transmission oil.

1. Unscrew the drain plug on the lower section of the transmission to drain contaminated transmission oil.
Since hot oil flows out of the engine first, be careful not to get burnt.
2. After draining oil, tighten the drain plug.
3. Add specified amount of transmission oil through the filling hole.
Filling hole(oil port) is located in rear of the seat.

 IMPORTANT

- Do not add transmission oil over upper limit level.
- Check the transmission oil before start the engine or at least 5 min after the engine is stopped.
- When trying to use new oil from a different manufacture or oil with different viscosity, drain used oil completely before adding new oil.
- Please refer to 「APPENDIX」 chapter for transmission oil specification and capacity.

 CAUTION

- If transmission oil gets on your skin, it can irritate the skin and cause a skin condition.
Make sure to clean your skin with soap and water or hand cleaner.
- Make sure to cool down the engine sufficiently before draining oil.
Oil is very hot and can cause a burn if changing oil right after the engine is stopped.
- Check transmission oil level after filling it.



► FRONT AXLE OIL CHECK

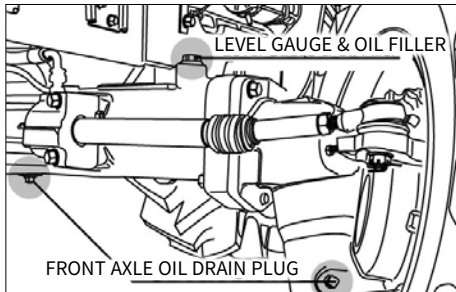

Follow the steps below to check front axle oil.

1. Park tractor on level surface, lower implements and shut off engine.
2. Remove front axle oil cap.
3. Wipe the dip stick on oil cap, dip and screw oil cap into front axle oil filling hole.
4. Unscrew oil cap and pull out.
5. Check the level with dip stick.
6. If the level is low, add more oil through filling hole.



► FRONT AXLE OIL CHANGE

Follow the steps below to change front axle oil.

1. Park the tractor on level surface.
2. Lower the implements and shut off the engine.
3. Remove front axle oil cap.
4. Remove the top plug (vent plug) from each final drive to vent air from final drives.
5. Remove the dip stick from the filter hole and add specified amount of front axle oil.
And allow time for the oil to drain into the final drives.
6. Check the oil level with the dipstick and replace the vent plugs on both final drives and tighten.

⚠ IMPORTANT

- Please refer to 「APPENDIX」 chapter for front axle oil specification and capacity.
- Some operators have found that when they fill with the correct amount of oil and dip it, the oil level on the dipstick is too high due to the fact that it takes a while for the oil to run into the final drives.
Opening the vent plugs helps to speed this up.

⚠ CAUTION

- Always ensure that you use the correct oil for topping up or oil changes.
- Check front axle oil level after filling it.

► AIR CLEANER DUST VALVE

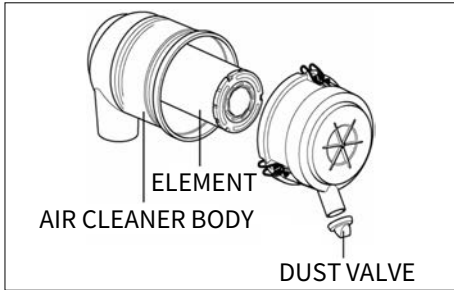

Pull out the valve with a hand and remove dust from its inside. If it is dirty or watery, wipe it with a dry rag thoroughly before fitting it again.

► AIR CLEANER ELEMENT

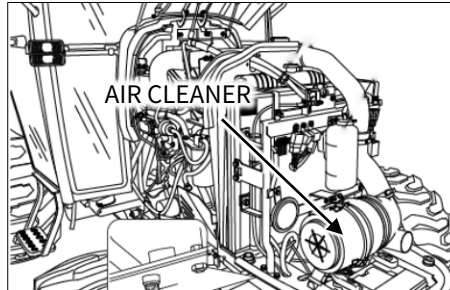

Follow the steps below to clean or change air cleaner element.

1. Remove the locking plate and split hose to separate air cleaner from the tractor.
2. Remove dust by blowing compressed air from the inside toward the outside of the element.
3. Keep proper distance between the air nozzle and element.

※ After cleaning the element 5 times or if it is damaged, replace with new element.

► CLEANING RADIATOR GRILLE

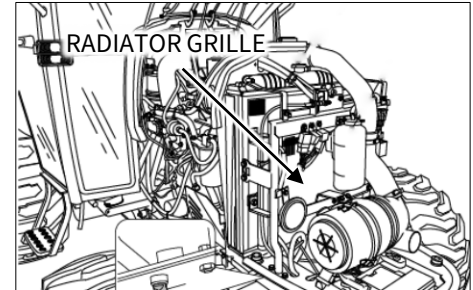

Follow the steps below to clean radiator grille.

1. Split and raise up rubber holder.
2. Raise up air cleaner hose.
3. Pull out radiator grille.
4. Gently clean radiator grille with air blower or tap water.

IMPORTANT

- Do not clean the radiator fin with water jet. It can deform the fin.



► ENGINE OIL FILTER CHANGE

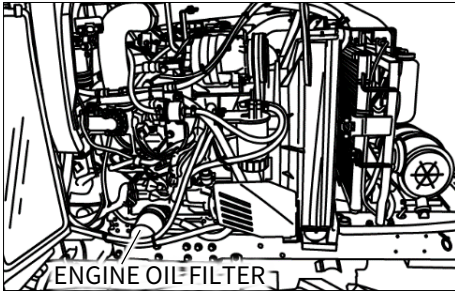

Follow the steps below to change engine oil filter.

1. Remove the oil filter using a filter wrench.
2. Smear lightly the rubber seal on the new filter with oil to ensure.
3. Turn the filter clockwise until the seal contacts the base and then turn it another 2/3 turn to tighten it.

► FUEL FILTER CLEANING

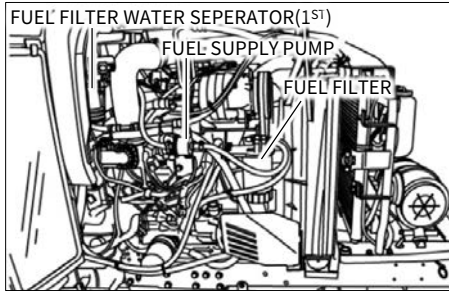

Fuel filter/water separator (if equipped) is not usually supplied by Yanmar.

The following test describes a typical fuel filter/water separator. Refer to the OEM information for further information in the fuel filter/water separator.

1. Turn fuel supply valve (if equipped) to OFF position before performing this maintenance.
2. Place a tray under fuel filter in order to catch any fuel that might spill.
3. Clean up any spilled fuel immediately.
4. Close fuel supply valve (if equipped).
5. Clean outside of fuel filter assembly.

• Note:

If fuel filter element is not equipped with a drain, remove cap. Remove nylon insert in order to reduce level of fuel in fuel filter element. A reduction in level of fuel in fuel filter element will help prevent fuel from being spilled when element is removed.

• Notice:

Do not use a tool in order to remove fuel filter. Attempting to remove fuel filter with a filter wrench or a filter strap could damage the locking ring.

6. Hold fuel filter and rotate quick release collar counterclockwise. Removed and discarded.

🚫 IMPORTANT

- Never use petrol (gasoline) thinner or similar inflammable material to wash the primary fuel filter.
- After replacing the filter always bleed the system.

► **BLEEDING FUEL SYSTEM**

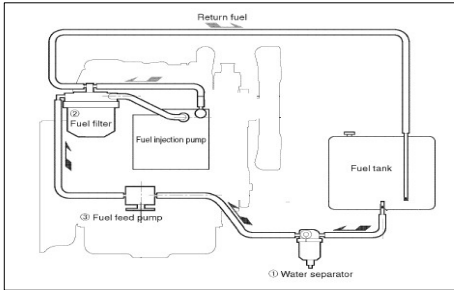

Follow next steps to bleed fuel system.

1. Fill the tank with fuel and turn the ignition key to on.
2. Loosen the air breather screw of the fuel filter two or three turns.
3. When fuel free from air flows (bubbles) from the air breather screw, tighten the Air breath screw.
4. The bleeding of the system is now finished.

► **HYDRAULIC OIL FILTER**

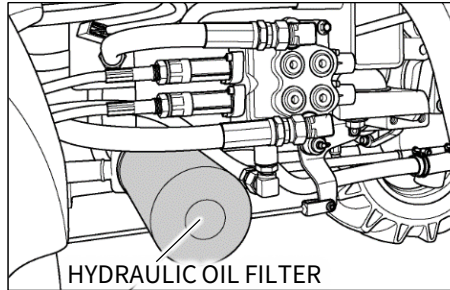

Follow next steps to check hydraulic filter.

1. Remove the filter with a filter wrench.
2. Apply oil or grease on the seal, fit by hand until seal contacts bare
3. Turn it 2/3rd turn further to tighten it check for leaks.

► **FUEL**

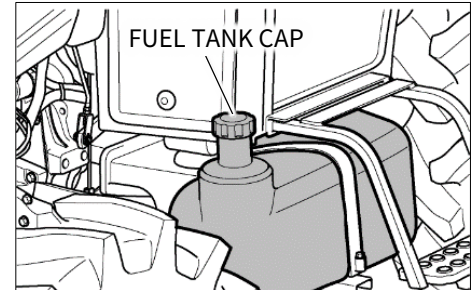

Use the fuel gauge to check the fuel level and top up if too low. It is a good practice to refill the tank immediately after use to avoid condensation.

 **CAUTION**

- As diesel fuel equipment is susceptible to contamination by dust or water. Ensure that all dust and water is kept well away from the fuel tank.



► FANBELT CHECK

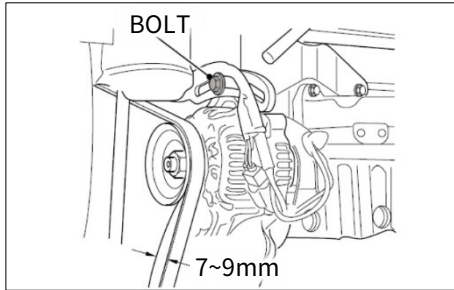

Check the fan belt tension regularly and adjust if required.

The correct tension is, if the center of the belt is pushed with a finger, that it moves in approx. 7 to 9 mm. under 6~7 Kgf.

To adjust the fan belt, loosen the top bolt on the alternator, move the alternator to the desired position and tighten the alternator pivot bolt and the link bolt to 22 N.m(16 lb ft) (1)

► ALTERNATOR INSPECT/ADJUST/REPLACE

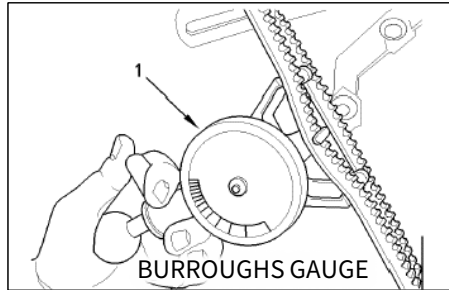

Yanmar recommends a scheduled inspection of alternator. Inspect alternator for loose connections and proper battery charging. Inspect ammeter(If equipped) during engine operation in order to ensure proper battery performance and/or proper performance of electrical system. Make repairs, as required. Check alternator and battery charger for proper operation. If batteries are properly charged, ammeter reading should be very near Zero. All batteries should be kept warm because temperature affects cranking power. If the battery is too cold, the battery will not crank the engine.

When engine is not run for long periods of time or if engine is run for short periods. Batteries may not fully charge. A battery with a low charge will freeze more easily than a battery with a full charge. For applications that require multiple drive belts, replace belts in matched sets. Replacing only one belt of a matched set will cause the new belt to carry more load because the older belt is stretched. The additional load on new belt could cause new belt to break. If belts are too loose, vibration causes unnecessary wear on belts and pulleys. Loose belt may slip enough to cause overheating. To accurately check belt tension, a suitable gauge should be used.

Fit the gauge(1) at center of the longest free length and check tension. Correct tension is 535N(120 lb). If tension of belt is below 250N(56 lb) adjust belt to 535 N (120 lb). If twin belts are installed, check and adjust the tension on the both belts.

► **AIR-CONDITIONER COMPRESSOR BELT ADJUSTMENT**

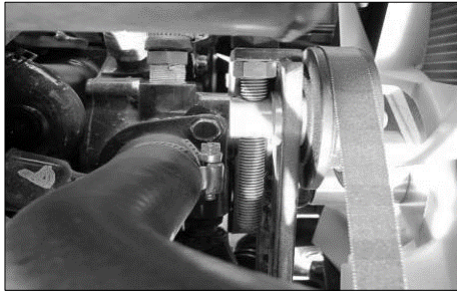

• **CHECK**

Check the compressor belt tension regularly and adjust if required. The correct tension is if the center of the belt is pushed with a finger it moves in approx. 10 mm (0.39 in) as shown in the picture.

• **ADJUST**

To adjust the belt, loosen the top bolt on the alternator, move the alternator to the desired position and tighten the bolt. Also ensure that the bottom alternator bolts are tight.

► **ADJUSTING BRAKES**

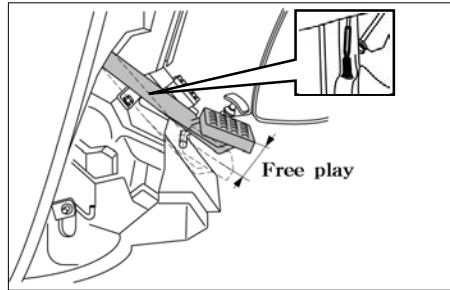

As is the case with the clutch, use of the brakes will change the pedal free play and the balance between the right and left pedal. The correct pedal free play is 3 ~ 4cm.

Follow the next steps to adjust.

1. Loosen the locknuts to adjust the brake.
2. Turning counterclockwise to increases the free play, or turning clockwise to decreases.
3. Tighten the locknut and confirm to fix the Nuts.
4. Check that the free play is correct and the same on both pedals to ensure even braking.

► **ADJUSTING THROTTLE LEVER, TOE-IN, HOSES AND LINES**

• **THROTTLE LEVER**

If this lever is either loose or difficult to move, please consult your workshop for rectification of the problem.

• **TOE-IN**

If the toe-in adjustment is incorrect it can cause severe shaking of both the steering wheel and the entire tractor. The correct toe-in is 2 ~ 6mm. (0.78 ~ 0.23 in.) We recommend that the adjustment is made by the workshop.

• **HOSES AND LINES**

The fuel lines, radiator hoses, hydraulic and rubber hoses are consumables, which deteriorate by age and use. Check them regularly and replace if faulty.

 **CAUTION**

- Damaged fuel lines leak and cause fires.
- Damaged radiator hoses can cause hot water burns and in severe cases seize the engine.



► TIRE PRESSURE

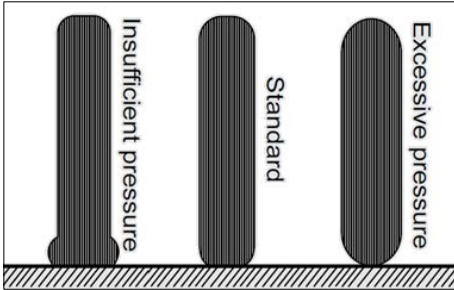

The air pressure used in the tires has a direct bearing on the life of the tire and its performance in the field.

Ensure that the tire pressures are correct.

To make a visual judgment, see drawing on top.

DANGER

- Excess tire pressure can cause accidents!

► TRACK ADJUSTMENT

As T455/T555NH models of TYM are front wheel assist the front track can be set in 2 positions. The rear track can be set in 5 positions as illustrated.

MODEL	DIVISION	TYRE	AIR PRESSURE (kg/cm ²)	TRACK ADJUSTMENT
T455, T555	FRONT	9.5-16 6PR	2.1	1,330mm
	REAR	13.6-26 8PR	1.5	1,264mm

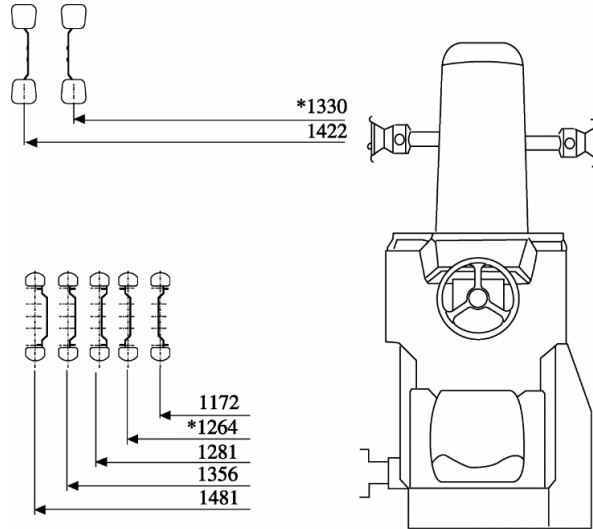

Unit : mm
(*) Marking is STANDARD

► **BATTERY CHECK**

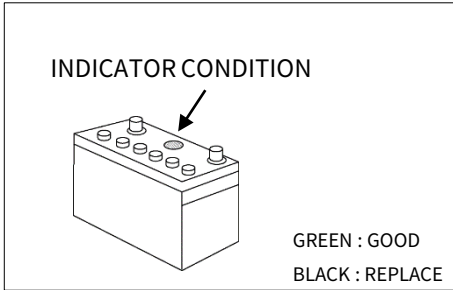

The original battery is maintenance free. But the water in the electrolyte can evaporate during use. So it needs to service for longer life.

The electrolyte level of the battery can evaporate during use thus lowering the level. Where it does so replace it with distilled water. Where a spillage has reduced the level, replace it with electrolyte.

 **CAUTION**

- Electrolyte contains acid and can cause serious burns.
- Any spillage on skin should be washed off by water immediately.

► **BATTERY MAINTENANCE**

- Low temperatures will affect the performance of batteries so take particular care of it in winter.
- For long-term storage of the tractor, remove the battery and keep it in a cool dry room.
If it is on the tractor while stored, disconnect the negative terminal.
- Batteries will self-discharge if left for a period of without use time.
- To keep them in good condition charge them once a month in summer and every second month in winter.
- When replacing the original battery, ensure that the replacement battery is the same size.
Failure to do so can cause problems with the electrical circuit.

 **IMPORTANT**

- Low electrolyte levels can cause premature battery failure and corrosion.

► **BATTERY JUMP START**

1. Turn off all electric devices.
2. Connect positive terminal of normal battery to the positive terminal of discharged battery with jump cable.
3. Connect the negative terminal of the normal battery to the engine body of the tractor for discharged battery with the jump cable.
4. Firstly, start the engine of the vehicle with the normal battery. Then, start the engine of the tractor with the discharged battery.
5. After the engine is started, disconnect the negative cable first. Then, disconnect the positive cable.
6. Charge the discharged battery for approx. 30 minutes after the engine is started.

 **CAUTION**

- Make sure to connect positive terminal first and connect negative terminal to the engine body of the tractor with the discharged battery.



► BATTERY DISCONNECTION KNOB



The function of the battery disconnection knob is to disconnect the power supply to the electrical system by interrupting the connection to the battery.

This has benefits for tractor safety and operation, in particular:

1. Protects the electrical system against short circuit.
2. Reduced battery self-discharge when the tractor left idle for prolonged periods.
3. Allows maintenance and repairs to be carried out in conditions of safety.

Turn the knob to “OFF” to disconnect the battery and back to “ON” to resume normal operation.

The battery disconnect knob is located on a bracket to the right of the battery. Putting the battery disconnect in safety condition.

The battery disconnect knob may be removed for safety purposes in the manner described following.



• REMOVAL OF THE KNOB

1. Turn the knob to the “off” position. The knob cannot be removed in this position.
2. Press the knob in and continue to turn it counter-clockwise as far as it will go.
3. Remove the knob.

• REFITTING THE KNOB

1. Refit the knob.
2. Press and turn the knob clock-wise, positioning it at 45°

► **HARNESS AND FUSES CHECK**

Loose wires make inferior connections and damaged wires can cause short circuits, fires burnt wiring or reduce efficiency of components. Replace or repair any faulty wiring or insulation. If a fuse burns out again after it has been replaced, do not replace it with wire or a high capacity fuse, find the cause and rectify it or get auto electrician to do so. Where insulation is chafed or peeled off, recover the area with a good quality insulation tape. Where wiring comes out of it's fitting replace it correctly with the standard fitting.

 **IMPORTANT**

- Incorrect wiring or fuses can cause fires to both the tractor and surrounding area so get the dealer to check it annually. Likewise fuel pipes and wiring age with use.
- Ask your dealer to check it at least once every 2 years and replace as required.

► **FUSE REPLACING**

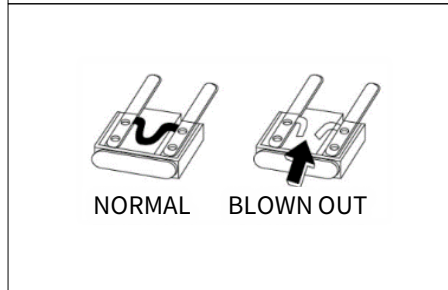

The circuit has blade type fuses in its wiring circuit. When a fuse has blown replace it with one of the same value. Using a large capacity fuse or wire burn out the wiring system. Use fuse tongs to replace fuses.

 **IMPORTANT**

- Always check the reason for a blown fuse otherwise the new fuse is also likely to blow.
- **NEVER EVER USE A WIRE** in place of correct grade fuse.

► **MAIN FUSES**

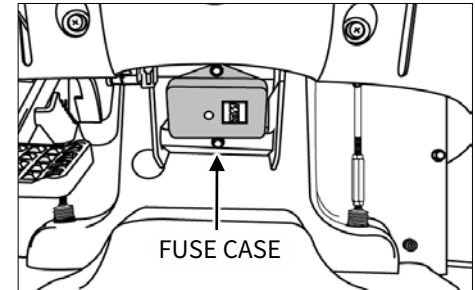

The wiring harness is equipped with main fuses whose function is to preserve the wiring. However when a main fuse blows the entire circuit is dead. Always check the reason & rectify before replacing the fuse of the same value. To indicate that the fuse is blown it will be discolored.



4. GREASING EACH PART

► GREASING THE TRACTOR

Grease the tractor according to the service schedule.

Ensure that grease nipples are cleaned well before any attempt is made to grease them.

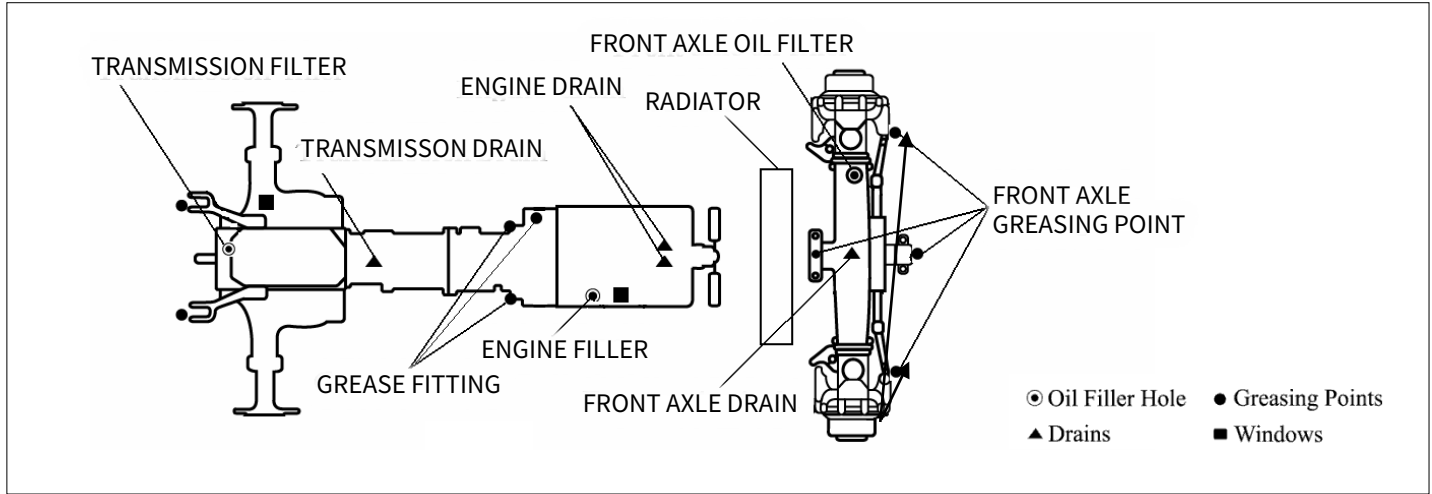

BRAKE AREA



LIFT ROD

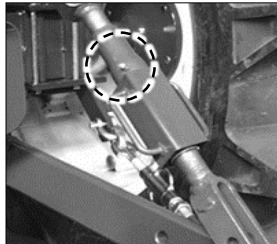

FRONT AXLE

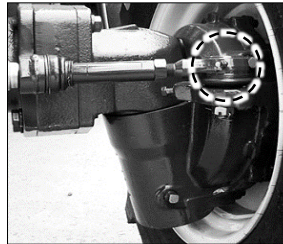

PIVOT METAL

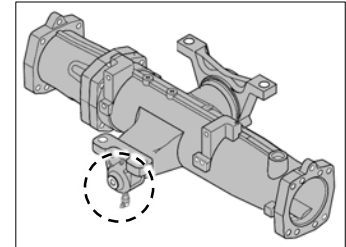

5. STORING THE TRACTOR

► SERVICE PRIOR TO DAILY AND SHORT TERM STORAGE

Wash the tractor and keep it clean.

Fill the tank to avoid condensation and rust.

Lower any attached implement to the ground before parking the tractor.

For long-term storage consult your dealer.

► FOR DAILY OR SHORT TERM STORAGE

Clean the tractor and remove all dirt from field work.

Fill the fuel tank to avoid condensation and rust.

Lower the implement to the ground. Keep it in a machinery shed or, if not available cover the unit if left outside.

In very cold conditions it is advisable to remove the battery and keep it inside in a warm environment.

This will ensure effective starting when the tractor is required.

When the outside temperature is below 0°C (32°F), replace the antifreeze completely or drain the coolant to protect the engine from damage from frozen coolant.

IMPORTANT

- When washing the tractor ensure that water does not get near electrical components or the oil filter points.
- To prevent short circuits remove the ignition key.
- Do not wash the tractor when the engine is running.



When the tractor will not be used for a long time carry out the cleaning as for short term storage.

Drain the oil and replace with new oil. Run the engine for approx. 5 min. to ensure that it has new oil throughout the engine.

Drain the coolant from the radiator and remove the ignition key.

Attach a tag both the key and the steering wheel saying 「No coolant」 . Lubricate all grease and oil points on the tractor.

Check the pressures and add a small amount of extra pressure.

Lower any implement to the ground or store in a shady dry place.

Place a piece of wood under each tire to preserve the tire.

IMPORTANT

- After refilling the engine with the coolant run the engine for approx. 5-10 min. at 1,500 ~ 2,000rpm every month as a corrosion prevention measure.
- Either removes the battery or the negative terminal as mouse damage to wiring can cause short circuits and fires.
- Remove the ignition key and store in a safe place.

▶ REUSE AFTER LONG TERM STORAGE

Carry out a full check of all oils and coolant.

Refit the battery and run the engine at idle for 30 min. to ensure optimum engine life.

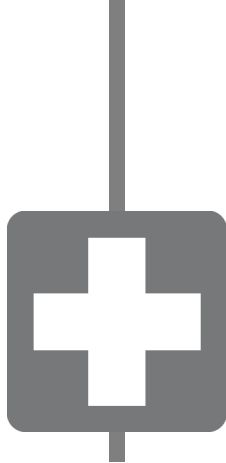

TROUBLESHOOTING

1. ENGINE TROULESHOOTING F - 2
2. BRAKE TROULESHOOTING F - 5
3. STEERING WHEEL & HYDRAULIC SYSTEM
TROULESHOOTING F - 6
4. ELECTRIC INSTRUMENTS TROULESHOOTING . . F - 7

1. ENGINE TROUBLESHOOTING

► ENGINE

	ISSUE	CAUSE	ACTION
ENGINE	The start motor does not rotate when the key switch is turned	<ul style="list-style-type: none"> • PTO switch is on 「ON」 position • Defective safety switch • Battery discharged • Loose terminal • Faulty key switch • Defective start motor 	<ul style="list-style-type: none"> • Set PTO switch into 「OFF」 position • Have it repaired or replaced by workshop • Charge battery • Check for looseness and corrosion Clean, tighten and apply grease • Have it repaired or replaced by workshop • Have it repaired or replaced by workshop
	The start motor runs, but its speed cannot be increased	<ul style="list-style-type: none"> • Weak battery • Poor ground • Incorrect viscosity of engine oil 	<ul style="list-style-type: none"> • Charge battery. • Clean contact and connect ground firmly • Change engine oil with proper viscosity
	The start motor runs, but engine cannot be started	<ul style="list-style-type: none"> • Air in fuel system • Clogged fuel filter • No fuel supply • Defective engine • Defective key stop unit 	<ul style="list-style-type: none"> • Bleed the system • Clean or replace the filter • Open the cock and add fuel • Have it repaired or replaced by workshop • Have it repaired or replaced by workshop
	Engine runs irregularly	<ul style="list-style-type: none"> • Air in fuel system • Clogged fuel filter • Clogged injection nozzle • Fuel leak from pipe • Poor fuel injection 	<ul style="list-style-type: none"> • Bleed the system • Clean or replace the filter • Have it repaired or replaced by workshop • Tighten clamp, replace pipe or machine surface of copper washer before installation • Have it repaired or replaced by workshop
	Engine stops at low speed	<ul style="list-style-type: none"> • Defective injection pump • Incorrect engine valve clearance • Low idle speed • Faulty nozzle 	<ul style="list-style-type: none"> • Have it repaired or replaced by workshop • Have it repaired or replaced by workshop • Adjust speed to the rated speed • Have it repaired or replaced by workshop

	ISSUE	CAUSE	ACTION
E N G I N E	The engine overruns	<ul style="list-style-type: none"> • Clogged governor by foreign material or dust • Oil increased 	<ul style="list-style-type: none"> • Have it repaired or replaced by workshop • Have it repaired or replaced by workshop
	The engine stalls suddenly	<ul style="list-style-type: none"> • Insufficient fuel • Faulty nozzle • Engine seizure by insufficient oil or poor lubrication 	<ul style="list-style-type: none"> • Add more fuel and bleed the system • Have it repaired or replaced by workshop • Have it repaired or replaced by workshop • Pull the fan belt. <p>If crank pulley is moved, it may indicate insufficient fuel and faulty nozzle</p>
	The engine is overheated	<ul style="list-style-type: none"> • Insufficient coolant amount • Loose or damaged fan belt • Clogged radiator • Insufficient engine oil 	<ul style="list-style-type: none"> • Add coolant • Adjust fan belt tension or replace it • Clean radiator • Inspect and replenish
	The engine produces white or black smoke	<p>White smoke</p> <ul style="list-style-type: none"> • Clogged air cleaner • Excessive engine oil amount • Insufficient fuel delivery amount <p>Black smoke</p> <ul style="list-style-type: none"> • Low quality fuel • Excessive fuel amount delivery • Insufficient nozzle pressure 	<p>White smoke</p> <ul style="list-style-type: none"> • Clean air cleaner element • Check and set the proper amount • Have it repaired or replaced by workshop <p>Black smoke</p> <ul style="list-style-type: none"> • Add specified fuel • Have it repaired or replaced by workshop • Have it repaired or replaced by workshop

	ISSUE	CAUSE	ACTION
E N G I N E	The engine power is insufficient	<ul style="list-style-type: none"> • Clogged or carbon on nozzle tip • Insufficient compression or gas leak from valve seat • Incorrectly adjusted valve clearance • Incorrect injection timing • Insufficient fuel • Clogged air cleaner • Urea supply shortage 	<ul style="list-style-type: none"> • Have it repaired or replaced by workshop • Have it repaired or replaced by workshop • Have it repaired or replaced by workshop • Have it repaired or replaced by workshop • Add more fuel • Clean the air cleaner element • Add more urea
	The oil warning lamp comes on during driving	<ul style="list-style-type: none"> • Low engine oil level • Low viscosity of engine oil • Faulty pressure switch • Defective oil pump • Oil filter element clogged 	<ul style="list-style-type: none"> • Add engine oil to specified level • Change oil with proper viscosity • Replace the switch • Have it repaired by workshop • Replace the element
	The charge warning lamp comes on during driving	<ul style="list-style-type: none"> • Defective wiring • Defective alternator • Defective battery or insufficient distilled water • Loose or damaged fan belt 	<ul style="list-style-type: none"> • Check for loose or missing terminal, short circuit and poor ground and repair as necessary • Have it repaired by workshop • Replace the battery or add distilled water • Adjust the tension or replace the belt

2. BRAKE TROUBLESHOOTING

► BRAKE

	ISSUE	CAUSE	ACTION
B R A K E	Brake does not operate or brake on one side operates only	<ul style="list-style-type: none"> • Excessive brake pedal free play • Worn or seized liner • Different play of left and right pedals 	<ul style="list-style-type: none"> • Adjust the free play • Have it repaired by workshop • Set the left and right free play to the same
	The brake pedal does not return to its original position properly	<ul style="list-style-type: none"> • Damaged brake return spring • No grease on sliding part 	<ul style="list-style-type: none"> • Replace the spring • Remove rust and apply grease

3. STEERING WHEEL & HYDRAULIC SYSTEM TROUBLESHOOTING

► STEERING WHEEL

	ISSUE	CAUSE	ACTION
S T E E R I N G	The steering wheel feels heavy or The steering wheel vibrates	<ul style="list-style-type: none"> • Improper toe-in • Incorrect tire inflation pressure • Vibration from each connection 	<ul style="list-style-type: none"> • Adjust toe-in • Set left and right tires to same specified pressure • Tighten or replace connection
	The free movement of steering wheel is excessive	<ul style="list-style-type: none"> • Worn steering wheel shaft • Worn metal parts • Free play from each connection 	<ul style="list-style-type: none"> • Have it repaired by workshop • Have it repaired by workshop • Tighten free play of each connection

► HYDRAULIC SYSTEM

	ISSUE	CAUSE	ACTION
H Y D R A U L I C	Oil leaks from the pipe or hose	<ul style="list-style-type: none"> • Loose clamps • Cracked pipes 	<ul style="list-style-type: none"> • Tighten clamps • Have it replaced by workshop
	Hydraulic pressure won't be decreased	<ul style="list-style-type: none"> • Lowering speed control lever fixed • Defective valve • Damaged cylinder • Damaged and seized lift shaft rotating part 	<ul style="list-style-type: none"> • Set it to the lowering position • Have it repaired by workshop • Have it repaired by workshop • Have it repaired by workshop
S Y S T E M	The hydraulic pressure won't be increased	<ul style="list-style-type: none"> • Insufficient engine RPM • Insufficient transmission fluid • Air sucked into suction pipe • Clogged oil filter • Defective hydraulic pump • Defective valve • Damaged cylinder 	<ul style="list-style-type: none"> • Set the speed to 1,000 to 1,500 RPM • Add to the specified level • Tighten the connection. If any pipe or hose is cracked or O-ring is damaged, replace them. • Have it repaired by workshop • Have it repaired by workshop • Have it repaired by workshop

4. ELECTRIC SYSTEM TROUBLESHOOTING

► ELECTRIC SYSTEM

	ISSUE	CAUSE	ACTION
E L E C T R I C S Y S T E M	The battery won't be charged	<ul style="list-style-type: none"> • Blown fusible link • Defective wiring • Defective alternator • Loose or damaged fan belt • Defective battery function 	<ul style="list-style-type: none"> • Check the wiring and replace the fusible link • Check for loose or missing terminal, short circuit and poor ground and repair as necessary • Have it repaired by workshop • Adjust the tension or replace the belt • Check for loose or corroded terminal and insufficient electrolyte and take any necessary action
	The headlamp does not produce enough light	<ul style="list-style-type: none"> • Low charging level of battery • Contact failure in wiring 	<ul style="list-style-type: none"> • Charge • Check, clean and re-tighten the ground and terminal
	The headlamp does not come on	<ul style="list-style-type: none"> • Blown bulb • Blown fuse • Contact failure 	<ul style="list-style-type: none"> • Replace the bulb • Check the wiring and replace the fuse • Check and clean the ground and terminal
	The horn does not operate	<ul style="list-style-type: none"> • Defective horn switch • Defective wiring • Damaged horn 	<ul style="list-style-type: none"> • Replace • Repair • Repair or replace
	The turn signal lamp does not blink	<ul style="list-style-type: none"> • Blown bulb • Defective flasher unit • Poor contact 	<ul style="list-style-type: none"> • Replace the bulb • Replace • Check and clean the ground and terminal
	The work lamp does not come on	<ul style="list-style-type: none"> • Blown bulb • Contact failure 	<ul style="list-style-type: none"> • Replace the bulb • Check and clean the ground and terminal

F



STANDARD FOR FARMWORK

TO ENSURE SAFE AGRICULTURAL WORK, SAFETY PRECAUTIONS FOR USE OF AGRICULTURAL MACHINERY ARE SET BY THE NATIONAL INSTITUTE OF AGRICULTURAL ENGINEERING.

READ THIS INFORMATION THOROUGHLY ALONG WITH THE USER MANUAL TO ENSURE SAFE WORK.



1. STANDARD FOR FARMWORK

► SAFETY MARK

Always make sure to check the operating condition of the safety lamp (such as turn signal lamp) before operating the machine.

※ If any lighting system is removed※
It may lead to an unexpected accident because it is not possible to give signals to people or machine nearby.

► INSTRUCTION BEFORE USE

Operator must attend his/her health and should get enough rest.

Before using the machine, check it and repair if there is a malfunction.

- Check if the assembly of front and rear wheels is okay.
- Check the tightening of bolts and nuts in each unit.

Do not drive if you are mentally unstable, drunk, pregnant, under the age of 16, not trained, overworked, sick, under the influence of drugs, and any other reason that may affect normal operation of the machine.

Please wear the appropriate working clothing.

- Put on a hard hat to protect your head.
- Put on a hat and a working clothes, to prevent an injury such as being twined into the machine.

- Protective measures to prevent any injury on foot or slipping - Put on an appropriate non-slippery shoes to prevent a fall from the machine, scattering soil, and slippery surface.
- Measures against dust and toxic gas.
- Wear an appropriate protective gear.
- Measures against the herbicide : wear protective gear to protect respiratory system, eyes and skin.
- Measures against noise : wear a protective gear to protect your ears.
- Handling protective gear : do neither let children get on the machine nor get close to the machine.

If it is not possible to park the agricultural machine on a road either due to a breakdown or any other reason, operator must take an action such as moving the equipment to a place other than a road.

Also, put a signal that there is a broken car, 100m behind and 200m at night in accordance with Automobile Regulation Article 23.

When starting to drive, make sure to check around carefully.

- Do not let anyone such as a child get close to the machine, keep them away and then drive the machine.

Do not load flammable, explosive material (diesel, gasoline , etc) on the machine.

When getting on and off a truck, have a helper give you signal and follow his/her lead.

Refer to chapter A in user's manual regarding the decals on the machine.

▶ CHECKUP LIST FOR OPERATION

Before using the machine, check it and repair if there is a malfunction.

Check engine oil.

- Pull out level gauge, wipe off any fuel leak, put it back in, and pull it out again to see if the oil level is between 「upper limit」 and 「lower limit」 .

Before any operation, check for any foreign materials caught on the engine, muffler, battery, and the fuel tank. Remove them immediately.

Covers that are removed during the maintenance work should be reinstalled to their original positions.

- Attach the cover correctly and firmly.

▶ CAUTIONS DURING THE WORK

Do not load anything that can interfere driving.

- Always keep the driver's seat clean.

Always buckle up when driving.

Opening radiator cap when heated can spring out the steam to have the operator burned.

Open the cap after it is sufficiently cooled down.

Do not drive with depressing the differential gear pedal.

Prohibit anyone to get on the machine.

- Prohibit anyone to get on the machine other than the designated place.
- Even though there are some designated place, do not let people more than capacity get on the machine.



- Never let any passenger mount on the machine.
Also, do not put any object on the machine.
Keep people away from the machine.
- Do not jump on/off the operating machine except for emergency.

Be cautious not to let anyone touch the belt .

Always check the connected area of belt. When two people are working collaboratively, exchange signals each other.

Prevent injury.

- Do not touch power transmission gear, rotating unit, and other dangerous parts.
- Pay special attention if you are working with the machine with blade or sharp projection.
- Be careful not to injure from the work where soils and stones are scattered around.

Safety in inspection, adjustment, etc.

- Make sure to stop the motor and carry out the work in a safe environment.
- When leaving the machine for a break, or other reason, leave the machine in a safe place and descend the working unit to keep them in a safe stopped state.

Removing and installing should be carried out in a safe place and with a safe method.

Do neither stay nor insert foot under the working units.

► CAUTIONS WHEN DRIVING ON FARM ROAD

Driving on roads

- Drive safely observing the relevant regulation.
- Drive at safe speed.
- Be careful not to disturb other drivers.
- When driving a machine with sharp blade or bump, put on a warning sign or detach in advance to prevent any injury.
- Do not drive fast particularly on winding roads with projecting rocks.
- When driving at night, do not detach lighting device. (headlight, turn indicator, work light, brake light, etc.)
- Do not drive fast, abrupt starting, abrupt acceleration, sudden stop, and quick turning.
- When driving at high speed, do not slam on the brake. Never slam on the brake especially when turning at high speed.

When loading/unloading the machine

- Choose a place with a leveled and safe ground.
- Drive at low speed.
- Use a ramp with anti-slippery.

When entering paved road

- Use a ramp to cross a ditch or a bank.
- Make sure to use a ramp to enter/exit a high footpath. Be careful with fall and not to overturn.
- Check the safety around the surrounding before starting to drive.

When driving on a slope

- Drive at the minimum speed, lower the operating machine as low as possible and low the center position.

► INSTRUCTION AFTER USE

When the work is completed, stop the engine on a leveled ground, check the machine to clean. (remove any foreign materials)

- Remove straws, dirt, etc. and clean around the engine, silencer, and fuel tank.

Lay a cover on the transplanter (equipment) after the muffler and engine cool down.

Get a regular inspection after the season is over.

- When discarding a part (battery, oil, etc.) or scrap a machine, consult to a dealer and proceed accordingly.

For long-term storage, remove the battery from the machine and store it or disconnect the negative battery cable.

► CAUTIONS FOR INSPECTION & MAINTENANCE

Do not refuel either when the engine is still hot or while driving.

Measures against a fire: Every working place with a risk of fire should be provided with a fire extinguisher. Prevent a fire by taking measures such as making a smoking area.

Always wipe off the leaked fuel.

Be seated in the cab when starting the engine.

After refueling, tighten the fuel cap and check if there is any fuel leakage from tank or pipe.

When opening a cap to supply water to radiator, be careful because steam or boiling water may spray due to overheating.



► TRACTOR

When getting off the cab, turn off the engine, lock the parking brake and remove the ignition key.

If it is inevitable to park on a slope, choke the wheels.

Park on a leveled and safe ground safely.

Check if the wiring code is in contact with other parts, peeled, loose or having spacing.

Manage PTO

- Stop PTO before stopping the engine.
- Do not remove the PTO protective cover or protective panel for operating machine.
- Do not use PTO adaptor in order to extend the PTO coupler or universal joint to outside of PTO protective cover.

To repair, secure the wheel width, or changing the wheel under either tractor or trailer, with the tractor or trailer raised, choke the wheels that are on the ground.

Do not use hydraulic jack for operating machine or tractor. Instead, use block or stand.

Safety frame

- Do neither weld nor drill a hole on the attached safety frame. Also do not modify it.
- Replace the damaged safety frame with a new one.

- If the safety frame was removed for specialized work, restore it immediately.

Be careful to touch dangerous area such as power transmission gear, rotating unit, etc. Put on a protective cover.

Do neither modify nor remove the safety device.

When checking and replacing the blade to plow the ground

- Stop the engine.
- Prevent the rotary from falling by turning the fall adjusting handle to stop hydraulic pressure.
- Apply the parking brake.
- Do not stand between tractor and rotary.

When working with rotary

- Do not put your hands near the rotating part such as blade axle and universal joint.

- Do not ride on the rotary.
- When driving backward or turning quickly with the rotary raised up, make sure to check behind the machine.
- Adjust the rear cover.

► OTHER PRECAUTIONS

The following items can affect the tractor performance and safety.

Therefore, Repair of these items should be done by your workshop.

- Injection pump, nozzle, engine valve clearance, hydraulic valve, hydraulic pump and evaporator.

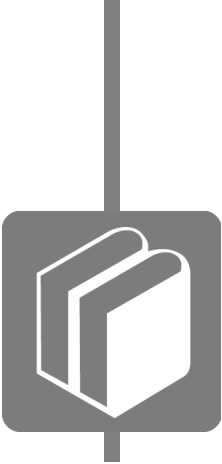

APPENDIX

1. SPECIFICATION	H - 2
2. TRAVELING SPEED	H - 4
3. FUSE BOX	H - 4
4. MASS AND TIRE	H - 5
5. DIESEL FUEL	H - 6
6. ENGINE COOLANT	H - 10
7. NOISE LEVEL	H - 13
8. VIBRATION REFERRED TO THE OPERATOR POSITION	H - 14

1. SPECIFICATION

SPECIFICATION		T455NH/SH	T555NH/SH	
ENGINE	MANUFACTURER	YANMAR	YANMAR	
	MODEL	4TNV88C-K	4TNV86CT-K	
	TYPE	LINE, WATER-COOLED DIESEL	LINE, WATER-COOLED DIESEL TURBO CHARGED	
	RATED OUTPUT	Kw(PS)	46 (34.3) @ 2,800	55.9 (41.1) @ 2,800
	NUMBER OF CYLINDER		4	4
	DISPLACEMENT	cm ³	133.6(2,189)	133.6(2,189)
	MAX TORQUE	N-m@rpm	146@1,820	175@1.820
ELECTRIC SYSTEM	BATTERY	12V80AH	12V80AH	
	ALTERNATOR	12V70A	12V70A	
DRIVE TRAIN	TRANSMISSION TYPE	HST	HST	
	NUMBER OF SPEEDS	Infinite/3 Range	Infinite/3 Range	
	BRAKES	Wet Disc	Wet Disc	
	STEERING	Hydrostatic	Hydrostatic	
HYDRAULIC SYSTEM	PUMP CAPACITY (MAIN)	L/MIN	9.5(36.1)	9.5(36.1)
	PUMP CAPACITY (POWER STEERING)	L/MIN	5.0(19.0)	5.0(19.0)
	NUMBER OF STANDARD REMOTE CONTROL VALVE (OPTION)		2	2
3 POINT LINKAGE	TYPE	Category 1	Category 1	
	LIFT CAPACITY (Lift Point)	kg (lbs)	1,503 (3,313)	1,503 (3,313)
	LIFT CAPACITY (24 in behind)	kg (lbs)	1,336 (2,945)	1,336 (2,945)
	LIFT CONTROL TYPE		POSITION / DRAFT	POSITION / DRAFT

SPECIFICATION		T455NH/SH	T555NH/SH
PTO	TYPE	Independent	Independent
	CONTROL	Electric/Hydro	Electric/Hydro
	MID (OPTION) RPM	N/A	N/A
	REAR RPM	540 / 1,000	540 / 1,000
	SHAFT DIAMETER mm	1 3/8 (35), 6 Splines	1 3/8 (35), 6 Splines
OIL CAPACITY	FUEL TANK liter(gallon)	60 (15.85)	60 (15.85)
	COOLANT liter(gallon)	5.5 (1.45)	5.5 (1.45)
	ENGINE OIL (with filter) liter(gallon)	4.3 (1.13)	4.3 (1.13)
	TRANSMISSION OIL liter(gallon)	43 (11.35)	43 (11.35)
	FRONT AXLE liter(gallon)	10 (2.64)	10 (2.64)
DIMENSION	OVERALL LENGTH mm (inch)	3,590 (1,413)	3,590 (1,413)
	OVERALL WIDTH mm (inch)	1,620 (637)	1,620 (637)
	OVERALL HEIGHT mm (inch)	ROPS:2,594 (1,021) / CABIN:2,530 (996)	ROPS:2,594 (1,021) / CABIN:2,530 (996)
	WHEELBASE mm (inch)	1,935 (761)	1,935 (761)
	MIN. GROUND CLEARANCE mm (inch)	350 (137)	350 (137)
	MIN. TURNING RADIUS mm (inch)	3,820 (1,503)	3,820 (1,503)
WEIGHT WITH ROPS OR CABIN kg (lbs)	ROPS:1,730 (3,813) / CABIN:1,920 (4,232)	ROPS:1,730 (3,813) / CABIN:1,920 (4,232)	
TIRE	FRONT Agri. / Turf / Industrial	9.5-16 / 12-16.5 / 12-16.5	9.5-16 / 12-16.5 / 12-16.5
	REAR Agri. / Turf / Industrial	13.6-16 / 17.5L-24 / 17.5L-24	13.6-16 / 17.5L-24 / 17.5L-24

- Consult your TYM dealer to purchase recommended oils and coolant.

2. TRAVELLING SPEED

SUB SHIFT	FORWARD	REVERSE	Km/H
L	0 ~ 6.198	0 ~ 6.198	
M	0 ~ 10.042	0 ~ 10.042	
H	0 ~ 29.439	0 ~ 29.439	

3. FUSE BOX

► DRAWING FOR FIXING POSITION OF THE FUSE

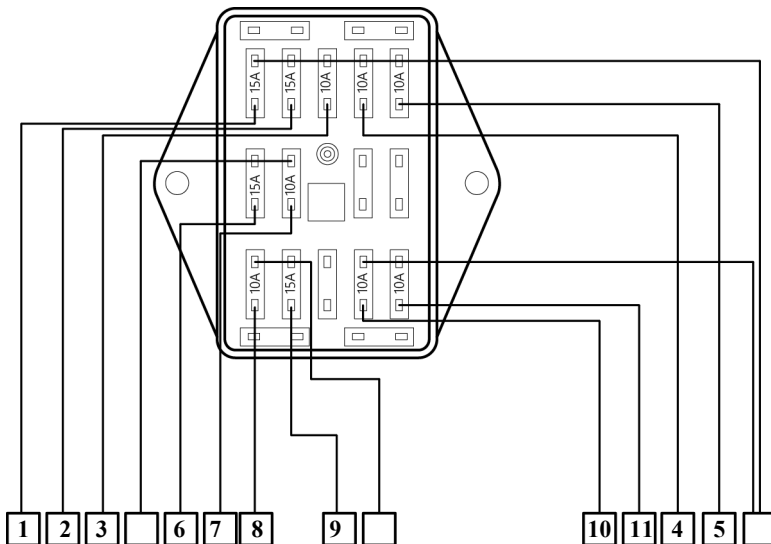

NO	ITEM	SPEC.
1	PANEL	15A
2	LIGHT, HORN	15A
3	WORKING LIGHT	10A
4	STOP LAMP	10A
5	TURN SIGNAL	10A
6	CONTROLLER	15A
7	ENGINE STOP	10A
8	FUEL PUMP	10A
9	COUPLER	15A
10	AUTO ROLLING	10A
11	QUICK TURN	10A

4. MASS AND TIRE

No.	Axle No	Tyre dimension including load capacity index and speed category symbol	Rolling Radius (mm)	Tire load Rating per tire [kg]	Maximum Permissible mass per axle [kg]	Maximum permissible mass of the vehicle [kg]	Permissible vertical load on the coupling point [kg]	Track width (mm)	
								Min.	Max.
1	F	9.5-16 6PR 96 A6 R-1	383	710	1400	T455, T555 ROPS : 3,150 T455, T555 CABIN : 3,325	T-CD11 : 500 Scharmüller 3,200/3,201 : 2,000 ~ 2,500	1330	1422
	R	13.6-26 8PR 123 A6 R-2	585	1550	1925			1264	1481
2	F	240/70 R16 104 A8 R-1	348	900	1400			1330	1422
	R	320/70 R24 116 A8 R-1	512	1250	1925			1264	1481
3	F	12-16.5 10PR 144 A2 R-3	376	2800	1400			1320	1320
	R	17.5L-24 8PR 139 A8 R-3	563	2430	1925			1370	1370
4	F	305/70-16.5 130 A2 R-4	375	1900	1400			1320	1320
	R	17.5L-24 6PR 132 A6 R-4	549	2000	1925			1370	1370
5	F	305/70-16.5 145 A2 R-4	375	2900	1400			1320	1320
	R	445/70-24 148 A8 R-4	549	3150	1925			1370	1370
6	F	260/70 R16 109 B R-1W	358	1030	1400			1330	1422
	R	320/85 R24 122 B R-1W	536	1500	1925			1264	1481
7	F	260/70 R16 109 B R-1W	358	1030	1400			1330	1422
	R	340/85 R24 125 B R-1W	552	1650	1925			1264	1481
8	F	280/70 R16 112 B R-1W	371	1120	1400			1330	1422
	R	380/85 R24 131 B R-1W	584	1950	1925			1264	1481
9	F	280/70 R16 112 B R-1W	371	1120	1400	1330	1422		
	R	360/70 R28 125 B R-1W	584	1650	1925	1264	1481		

5. DIESEL FUEL

► DIESEL FUEL SPECIFICATIONS

Diesel fuel should comply with the following specifications. The table list several worldwide specifications for diesel fuels.

DIESEL FUEL SPECIFICATION	LOCATION
ASTM D975 NO. 1D S15 NO. 2D S15	USA
EN590:96	EU
ISO 8217 DMX	INTERNATIONAL
BS 2869-A1 OR A2	UK
JIS K2204 GRADE NO.2	JAPAN
KSM 2610	S. KOREA
GB252	CHINA

► ADDITIONAL TECHNICAL FUEL REQUIREMENTS

- The fuel cetane number should be equal to 45 or higher.
- The sulfur content must not exceed 0.5% by volume. Less must not exceed 0.5% is preferred. For electronically controlled EGR engine, use fuel with sulfur content of less than 0.1%. A higher sulfur content fuel may cause sulfuric acid corrosion in the cylinders of the engines. Especially in U.S.A. and Canada, Ultra Low Sulfur fuel must be used.
- Bio-Diesel fuels. See Bio-diesel fuels on next page.
- Never mix kerosene, used engine oil or residual fuels with the diesel fuel.
- Water and sediment in the fuel should not exceed 0.05% by volume.
- Keep the fuel tank and fuel-handling equipment clean at all times.
- Poor quality fuel can reduce engine performance and/or cause engine damage.
- Fuel additives are not recommended. Some fuel additives may cause poor engine performance. Consult your YANMAR representative for more information.
- Ash content not to exceed 0.01% by volume.
- Carbon residue content not to exceed 0.35% by volume. Less than 30% is preferred.
- PAH(polycyclic aromatic hydrocarbons) content should be below 10% by volume.
- Metal content of Na, Mg, Si and Al should be equal to or lower than 1 mass ppm. (Test analysis method JPI-5S-44-95)
- Lubricity: Wear mark of WS 1.4 should be Max. 0.018 in. (460 μm) at HFRR test.

► BIO-DEISEL FUELS

1. Bio-diesel is a renewable, oxygenated fuel made from agricultural and renewable resources such as soybeans or rapeseeds. Bio-diesel is a fuel comprised of methyl or ethyl ester-based oxygenates of long chain fatty acids derived from the transesterification of vegetable oils, animal fats, and cooking oils. It contains no petroleum-based diesel fuel but can be blended at any level with petroleum-based diesel fuel. In case it is not blended with petroleum-based diesel fuel such bio-diesel is referred to as “B 100”, which means that it consists of 100%(pure) bio-diesel. However, most common bio-diesel is blended with conventional (petroleum-based) diesel fuel. The percentage of the blend can be identified by its name. The most common blends are “B 7” (consisting of 7% bio-diesel and 93% conventional petroleum-based diesel fuel) and “B 20” (a blend of 20% bio-diesel fuel) and “B 20” (a blend of 20% bio-diesel and 80% conventional diesel). Raw pressed vegetable oils are not considered to be bio-diesel.
2. Advantages of bio-diesel.
 - Bio-diesel produces less visible smoke and a lower amount of particulate matter.
 - Bio-diesel is biodegradable and non-toxic.
 - Bio-diesel is safer than conventional diesel fuel because of its higher flash point. Following the increased interest in the reduction of emissions and the reduction of the use of petroleum distillate based fuels; many governments and regulating bodies encourage the use of bio-diesel.
3. Disadvantages of bio-diesel: Concentrations that are higher than 7% of bio-diesel (higher than B 7) can have an adverse affect on the engine’s performance, its integrity and/or durability. The risk of problems occurring in the engine increases as the level of bio-diesel blend increases. The following negative affects are exemplary and typical for the usage of high concentrated bio-diesel blends:
 - Bio-diesel can accelerate the oxidation of Aluminum, Brass, Bronze, Copper and Zinc.
 - Bio-diesel damages, and finally seeps through certain seals, gaskets, hoses, glues and plastics.
 - Certain natural rubbers, nitride and butyl rubbers will become harder and more brittle as degradation proceeds when used with bio-diesel.
 - Bio-diesel typically creates deposits in the engine.

- Due to its natural characteristic, bio-diesel will decrease the engine output by approximately 2 percent (in case of B 20) comparing to conventional (petroleum-based) diesel fuel.
- The fuel consumption ratio will increase by approximately 3 percent (in case of B 20) comparing to conventional diesel fuel.

► APPROVED ENGINES

All of the following engine series of YANMAR can be operated with bio-diesel with concentrations up to B 20. In case of using bio-diesel fuel up to B 7 concentrations, no special preparations etc. have to be made and the original operating conditions and service intervals as stated in the operating manuals apply.

In case of running below indicated engine with bio-diesel concentrations above B 8 up to B 20, the required operating conditions (see below Conditions for the operation with bio-diesel (B 8 through B 20)) have to be observed.

Other than the following listed engines cannot be run with bio-diesel:

1. 3TNM74F, 3TNV74F, 3TNV80F and 3TNV88F Tier 4

► APPROVED FUEL

In case of using bio-diesel (only concentrations up to B 20) such fuel should comply with the below recommended standards.

However, raw pressed vegetable oils are not considered to be bio-diesel and are not acceptable for use as fuel in any concentration in YANMAR engines.

1. EN14214 (European standard) and/or ASTM D-6751 (American standard).
2. All applicable engines can be operated with bio-diesel fuel up to B 20 (20 % bio-fuel blend) as a maximum concentration. (For your information: In Japan, the legally allowed maximum concentration for on-road applications is B 5.)

► CONDITIONS FOR THE OPERATION WITH BIO-DIESEL B 8 THROUGH B 20

When operating your applicable YANMAR engine with bio-diesel blends concentrated above B 5, we seriously recommend observing the following operation, service and maintenance conditions:

1. The original service interval of the below stated services as indicated in the respective YANMAR engine standard operation manual, the application manual and the service manual should be halved (please refer to your own manuals for the each service interval):
 - Replacement interval of engine oil filter, engine oil and the fuel filter.
 - Cleaning interval of the water separator
 - Drain interval of the fuel tank.
2. It is required to inspect, clean and adjust the fuel injector every 1000 operating hours.
3. Replacement of the following parts before using the recommended bio-diesel:
 - Fuel hose
 - Fuel feed pump (diaphragm type)
 - If not already installed, a water separator needs to be built in
 - 0-ring of fuel filter
 - 0-ring of water separator
Please refer to the attached list of exchange parts for details.
4. Please use only bio-diesel fuel that is appropriate to the intended operation environment of the engines. This especially applies if the operating ambient temperature falls below 0 degree centigrade.
5. Operation with bio-diesel requires daily maintenance as follows:
 - Please daily check the engine oil level.
If the oil level rises above the oil level of the previous day, the engine oil needs to be immediately replaced.
 - Please daily check the water level of the water separator.
If the water level rises above the "max" indicator, an immediate drain of the water separator is required.
6. Bio-diesel blends up to B 20 can only be used for a limited time of up to 3 months of the date of bio-diesel manufacture.
Therefore bio-diesel needs to be used at latest within 2 months from the time of filling the tank or within 3 months from the time of production by the fuel supplier, whichever comes first.
7. Before a long-term storage without operating the engine, the bio-diesel needs to be drained out completely and the engine has to be run for 5 hours with conventional diesel fuel as indicated in your operation manual.

6. ENGINE COOLANT

► ENGINE COOLANT

The heat generated by combustion process radiates to neighboring engine components.

If the cooling system is inadequate, the cylinder head, combustion chamber, pistons and exhaust valves overheat and their materials lose strength, leading to component failures and shorter engine service life.

Inadequate cooling also causes the engine oil to degrade prematurely which reduces its lubrication efficiency. This may result in abnormal component wear and seizure.

If the engine coolant temperature is too low, the engine's thermal efficiency is lowered, causing poor combustion. This may also cause cylinder bores to rust or corrode.

Corrosion results from reaction between carbon monoxide and sulfur dioxide generated in the combustion process and the water which condenses out of the exhaust gases.

► CHARACTERISTICS OF WATER

The following discussion does not imply that plain water can be used as an engine coolant. It is for illustrative purposes only.

Always use an engine coolant that is specified by YANMAR.

Without any measures to increase its boiling point or reduce its freezing point, water boils at 100 °C (212 °F) and freezes at 0°C (32 °F). To expand its temperature range, the following measures are taken:

- To increase boiling point of water, the cooling system is pressurized. A radiator cap helps to maintain the cooling system pressure. For example, if the cooling system pressure is 0.9 kg/cm², the boiling point can be raised to approximately 118 °C (244 °F).
- To lower the freezing point, anti-freeze, also called Long Life Coolant "LLC", is used. The specific freezing point depends on the concentration of anti-freeze used.

- Note: Plain water is not suitable as an engine coolant. Pure water leaves deposits and rust that have very low thermal conductivity. This results in the lack of cooling performance and causes damage to internal engine components.

A YANMAR standard engine coolant switch is activated at $110 \pm 3^{\circ}\text{C}$ ($230 \pm 37^{\circ}\text{F}$) as an overheat alarm.

Therefore the engine coolant needs to be within the specified limits under all working conditions.
Water quality needed to prepare engine coolant.

► **RECOMMENDED WATER QUALITY STANDARDS AND MAJOR TROUBLES FROM PRO WATER QUALITY**

NO	ITEM	RECOMMENDED VALUE	DESCRIPTION	MAJOR TROUBLE	
				CORROSION	SCALE
1	Ph 25°C(77°F)	6.3 ~ 8.5	Expresses hydrogen ion concentration in an aqueous solution Used as the measure of neutrality (pH = 7), acidity (pH < 7) or alkalinity (pH > 7). Acidity increases corrosion and alkalinity increases scale generation. Generally, pH of natural water is between 6 and 8.	✓	✓
2	Electrical conductivity 25°C (77°F)	< 0.04 S/m	Indicates micro-mho per cm. High electrical conductivity means a high content of electrolytic ions and solids in the water, which increase corrosion and scale generation.	✓	✓
3	Total hardness (CaCO ₃)*	< 100 ppm	Indicates the quantity of Ca ions and Mg ions in the water by the corresponding calcium carbonate in ppm. High total hardness increases scale generation.	-	✓
4	M alkalinity (MaCO ₃)	< 150 ppm	Indicates whole alkaline content in the form of hydroxides, carbonates and bicarbonates by the corresponding calcium carbonate in ppm. High M alkalinity means dissolution of alkaline content, which increases scale generation.	-	✓
5	Chlorine ion content (Cl ⁻)	< 100 ppm	Indicates chlorine ion content. High chlorine ion content increases corrosiveness. The water supply of Japan contains approximately 10 to 40 ppm of chlorine ions	✓	-
6	Sulfate ion content (SO ₄ ²⁻)	< 100 ppm	Indicates the sulfate ion content in water. High sulfate ion content causes copper corrosion. If Ca ion content is also high, CaSO ₄ is generated by the reaction with Ca ²⁺ , which increases scale generation.	✓	✓
7	Total iron (Fe)	< 1.0 ppm	Indicates the iron content. When 0.3 ppm is exceeded, coloring by precipitation occurs. High iron content causes scale generation.	✓	✓
8	Silica (SiO ₂)	< 50 ppm	Indicates Silicon Dioxide content. Hard scale is generated by combination with Ca and M2. This is not a serious problem if the water hardness is low.	-	✓
9	Evaporation residue	< 400 ppm	Quantity of non-soluble substances obtained by evaporation. Large amounts of suspended solids increase electrical conductivity, which increases corrosion.	-	✓
10	Nitrate ion	< 5 ppm		✓	
11	Ammonium ion	< 0.05 ppm		✓	
12	Sulfur ion (S ²⁻)	< 1 ppm		✓	

Note: use soft water instead of hard water.

Water softness or hardness is determined by the amount of Ca (calcium) ion and Mg (magnesium) ion in the water.

H

► REQUIRED ENGINE COOLANT CHARACTERISTICS

mixture of LLC and water is commonly used as an engine coolant. The most commonly used LLC is made of Ethylene Glycol.

Engine coolant concentrate must provide adequate corrosion protection, lower the freezing point, and raise the boiling temperature of the engine coolant.

VOL% ANTI-FREEZE	FREEZING POINT	BOILING POINT
40	-24°C(-11°F)	106°C(223°F)
50	-37°C(-35°F)	108°C(226°F)
60	-52°C(-62°F)	111°C(232°F)

Note: Boiling point can be raised if the cooling system is pressurized.

A radiator pressure cap helps to maintain system pressure.

Commercially available premixed LLC and water is recommended to ensure good water quality.

► TYPICAL PROPERTIES OF LLC (YANMAR STANDARD)

1	Density 20 °C (68 °F), g/cm ³ (undiluted):	1.136
2	Boiling point, °C (° F), (undiluted):	171 (340)
3	Flash point, 0c (°F), (undiluted):	-
4	Foaming characteristics, ml, (30 %, solution):	0
5	Water, wt%, (undiluted):	-
6	Freezing point, °C (°F) (50 vol %, solution):	-37.1 (-34.8)
	(30 vol %, solution):	-
7	Reserve Alkalinity (undiluted):	8.2
8	pH (30 vol %, solution):	7.8
9	Corrosion, mg/cm ² (20 vol % solution, 88 °c (190 °F) x 336 hrs)	
	Aluminum:	-0.02
	Iron:	-0.10
	Steel:	0.00
	Brass:	-0.03
	Solder:	-0.05
	Copper:	0.00

If YANMAR standard LLC is not available, YANMAR recommends using a LLC that conforms to the following specifications.

- JIS K-2234 (Japanese Industrial Standard)
- SAE J814 (Engine Coolants)
- SAE J1 034 (Automotive and Light Truck Engine Coolant Concentrate)
- ASTM D3306 (Specification for Ethylene Glycol Base Engine Coolant)

6. NOISE LEVEL

The tractor is approved in accordance with the applicable EC Directives.

To avoid increased noise levels proceed as follows:

- After maintenance operations or repairs refit all the sound-deadening panels and materials correctly
- Do not make changes to the tractor that may lead to an increase in noise emissions.
- Beware of any anomalous noise or vibration if you notice anomalous noise or vibration, park the tractor in a safe position and perform the stopping procedure. Inform maintenance personnel of the situation. Avoid prolonged operation.

Reference standards for the measurement of noise levels:

- The maximum driver-perceived noise level, with the engine at normal operating temperature and measured in accordance with the test method described in the European Directive 2009/76EC

MODEL	NOISE LEVELS	
	Driver-perceived sound level [dB(A)]	
	Cab(openings closed)	Roll bar
T455 / T555NC		85
T455 / T555ST	82	

- The maximum noise level measured with the tractor in motion and the tractor stationary, measured in accordance with the method described in European directive 2009/63/EC.

MODEL	NOISE LEVELS			
	Maximum external noise level With tractor moving, db(A)		Maximum external noise level With tractor stationary, db(A)	
	Cab	Roll bar	Cab	Roll bar
T455 / T555NC	-	83.5	-	83.2
T455 / T555ST	81	-	76.5	-



7. VIBRATION REFERRED TO THE OPERATOR POSITION

The value is referred to the amount of mechanical vibration transmitted by the tractor to WHOLEBODY as defined by UNI ISO2631-1:2008.

Said value must be utilized for assessment of the vibration exposure risk, but it cannot cover all the possible conditions of use of the tractor since it may vary in accordance with parameters that are not always related to the tractor (terrain, implements, etc.) If the risk assessment cannot be considered to be exhaustive or if the risk may exceed the values defined in 2002/44/EC, the use of a vibration mater s prescribed.

In order to minimize the vibration transmitted to the whole-body the following best practice rules should be observed:

- Use the most suitable implement for the tractor and the task in hand
- Adjust the seat to suit your weight and stature
- Periodically check the condition of the cab suspensions and renew them if damaged
- Check tire inflation pressure
- Use front axle suspensions, if fitted
- During transfers, adjust tractor speed in order to minimize the vibration level.

The seat vibration values, as obtained from the seat approval in compliance with 78 /764/EEC (amended by 1999/57/EC) are shown in the following table.

Technical data:

Input vibration : Category A, Class I ,II and III

Ambient temperature : 23°C

SEAT	DRIVER TYPE	CORRECTED VIBRATION LEVEL ON SEAT
W09SSS	LIGHT DRIVER (59kg)	1.24m/sec ²
	HEAVY DRIVER (98kg)	1.12m/sec ²



INDEX

1. INDEX | - 2



NUMBERS

4WD LEVER C-13

A

A/C, HEATER SYSTEM C-25

ABOUT THIS MANUAL A-6

ADDITIONAL TECHNICAL FUEL

REQUIREMENTS H-6

ADJUSTING BRAKES E-13

ADJUSTING THROTTLE LEVER, TOE-IN,

HOSES AND LINES E-13

ADJUSTMENT OF LIFT LINK ON LOWER

LINK C-19

ADJUSTMENT OF LOWER LINK C-19

ADJUSTMENT OF TOP LINK C-18

AIR CLEANER DUST VALVE E-9

AIR CLEANER ELEMENT E-9

AIR CLEANING SYSTEM D-21

AIR CONDITIONING SYSTEM C-27

AIR FILTER CONTAMINATED LAMP C-10

AIR-CONDITIONER COMPRESSOR BELT

ADJUSTMENT E-13

ALTERNATOR

INSPECT/ADJUST/REPLACE E-12

ALWAYS USE SAFETY LIGHTS AND

DEVICES B-5

ANTI-FREEZE E-5

APPENDIX H-1

APPROVED ENGINES H-8

APPROVED FUEL H-8

AUDIO SYSTEM C-29

AUTO THROTTLE SWITCH C-4

AUTOMATIC REGENERATION D-9

AVOID HIGH PRESSURE FLUIDS B-6

B

BACK SIDE OF THE TRACTOR A-4

BATTERY CHARGING D-13

BATTERY CHECK E-15

BATTERY DISCONNECTION B-8

BATTERY DISCONNECTION KNOB E-16

BATTERY JUMP START E-15

BATTERY MAINTENANCE E-15

BIO-DEISEL FUELS H-7

BLEEDING FUEL SYSTEM E-11

BRAKE D-22

BRAKE PEDALS C-12

BRAKE TROUBLESHOOTING F-5

C

CABIN C-20

CABIN AIR INTAKE FILTER C-28

CABIN CEILING C-23

CABIN IN GENERAL C-21

CAUTIONS FOR DRIVING ON ROAD D-6

CAUTIONS FOR DRIVING INTO OR OUT

OF FIELD D-6

CHARACTERISTICS OF WATER H-10

CHARGE WARNING LAMP C-9

CHECK REFRIGERANT CHARGE C-30

CHECKING AIR CONDITION SYSTEM C-29

CHECKS & SERVICING EACH PART E-5

CHECKS DURING DRIVING D-13

CLEANING RADIATOR GRILLE E-9

COMBINATION SWITCH C-3

COMPRESSOR BELT ADJUSTMENT C-27

CONDITIONS FOR THE OPERATION

WITH BIO-DIESEL B 8 THROUGH B 20 H-9

CONNECTION TO IMPLEMENTS D-10

CONTROL INSTRUMENTS C-11

COOLANT CHANGE E-5

COOLANT CHECK E-5

COOLANT TEMPERATURE D-14

COOLANT TEMPERATURE WARNING

LAMP C-9

COOLING SYSTEM D-24

CRUISE CONTROL LAMP C-10

CRUISE CONTROL SWITCH C-5

CRUISE SPEED CONTROL SWITCH C-5

CUP HOLDER, POWER SOCKET C-29

D

DAMAGE OF ROPS A-11

DECALS ON CHASSIS B-25

DESCRIPTION A-8

DIAGNOSING MALFUNCTIONS OF A/C C-31

DIESEL FUEL H-6

DIESEL FUEL SPECIFICATIONS ····· H-6
 DIFFERENTIAL LOCK PEDAL ····· C-14
 DISCONNECTION FROM IMPLEMENTS ··· D-10
 DON'Ts – FOR SAFE OPERATION ····· B-23
 DOORS ····· C-21
 DOs – FOR BETTER PERFORMANCE ··· B-22
 DOs & DON'Ts ····· B-22
 DRAFT CONTROL LEVER ····· C-15

E

ELECTRIC SYSTEM TROUBLESHOOTING ··· F-7
 EMERGENCY EXITS ····· B-9
 ENGINE ····· D-21
 ENGINE COOLANT ····· H-10
 ENGINE IDLING ····· D-3
 ENGINE OIL CHANGE ····· E-6
 ENGINE OIL CHECK ····· E-6
 ENGINE OIL FILTER CHANGE ····· E-10
 ENGINE TROUBLESHOOTING ····· F-2
 ENGINE WARNING LAMP ····· C-9
 ENSURE SAFETY INFORMATION ····· B-2
 EXTERIOR VIEW ····· A-2

F

FALLING OBJECT PROTECTIVE
 STRUCTURE (FOPS) ····· B-13
 FANBELT CHECK ····· E-12
 FIGURE OF CABIN ····· C-20
 FIGURE OF DASHBOARD ····· C-2

FIGURE OF DIAGRAM OF ELECTRIC
 INSTRUMENTS ····· H-5
 FIGURE OF MONITOR PANEL ····· C-7
 FIGURE OF THREE POINT LINKAGE ····· C-17
 FIGURE OF TRACTOR CONTROLS ····· C-11
 FOR DAILY OR SHORT TERM STORAGE ··· E-18
 FOR SAFE LOADER WORK ····· D-19
 FRONT AXLE OIL CHANGE ····· E-8
 FRONT AXLE OIL CHECK ····· E-8
 FUEL ····· E-11
 FUEL FILTER CLEANING ····· E-10
 FUEL GAUGE ····· C-8
 FUEL GAUGE ····· D-14
 FUEL WARNING LAMP ····· C-8
 FUSE BOX ····· H-4
 FUSE REPLACING ····· E-17

G

GENERAL IMPLEMENT ····· D-15
 GENERAL INFORMATION ····· A-1
 GENERAL INFORMATION OF DECALS ··· B-24
 GLOW LAMP ····· C-9
 GREASING EACH PART ····· E-18
 GREASING THE TRACTOR ····· E-18

H

HANDLE FUEL SAFELY AVOIDING FIRES ··· B-5
 HARNESS AND FUSES CHECK ····· E-17
 HAZARD WARNING SWITCH ····· C-3

HOURLY METER ····· C-8
 HOW TO CHECK A/C SYSTEM WITH
 NEEDLE OF HIGH LOW GAUGE ····· C-30
 HOW TO START ENGINE ····· D-2
 HYDRAULIC OIL FILTER ····· E-11

I

IDLING IN COLD WEATHER ····· D-3
 IMPLEMENTS ····· D-10
 INDEX ····· I-2
 INSIDE OF CABIN ····· C-24
 INTERIOR LAMP ····· C-25
 INTRODUCTION & DESCRIPTION ····· A-7
 INTRODUCTION OF A TRACTOR ····· A-7

J

JOYSTICK LEVER ····· C-16

K

KEEP RIDERS OFF TRACTOR ····· B-4
 KEY SWITCH ····· C-3

L

LEFT SIDE OF THE TRACTOR ····· A-3
 LIGHT LAMP ····· C-8
 LOADER ····· D-19
 LOADING TO OR UNLOAD FROM TRUCK ··· D-6
 LOWERING SPEED CONTROL KNOB FOR
 3 POINT LINKAGE ····· C-14



LUBRICATING OIL ······ D-22

M

MAIN FUSES ······ E-17

MAINTENANCE ······ E-1

MAINTENANCE SCHEDULE ······ E-2

MONITOR PANEL & GAUGES ······ C-7

MOUNTING AND DEMOUNTING

IMPLEMENTS ······ B-17

MOUNTING IMPLEMENTS ······ D-10

O

OIL PRESSURE ······ D-13

OIL PRESSURE WARNING LAMP ······ C-9

OIL SYSTEM ······ D-22

OPENING COVERS ······ E-4

OPENING HOOD ······ E-4

OPENING SIDE COVER ······ E-4

OPERATING PTO ······ D-7

OPERATING TRACTOR ······ D-4

OPERATION ······ D-1

OPERATION OF DPF ······ D-9

OPERATION OF PTO ······ D-7

OPERATION TIPS ······ D-21

OPERATOR PROTECTIVE STRUCTURE

(OPS) ······ B-13

OTHERS ······ D-24

OWNER ASSISTANCE ······ A-9

P

PARK TRACTOR SAFELY ······ B-4

PARKING BRAKE LAMP ······ C-10

PARKING BRAKE LEVER ······ C-12

PARKING THE TRACTOR ······ D-5

PERIODICAL CHECK AND SERVICE

TABLE ······ E-2

POSITION LEVER ······ C-15

PRACTICE SAFE MAINTENANCE ······ B-6

PRECAUTION TO AVOID TIPPING ······ B-4

PRECAUTIONS FOR HANDLING

IMPLEMENTS ······ D-15

PREVENT ACID BURNS ······ B-7

PREVENT BATTERY EXPLOSION ······ B-7

PRINCIPLE OF AUTO PREHEATING

SYSTEM ······ D-2

PROTECT CHILDREN ······ B-3

PTO LAMP ······ C-9

PTO MODE SWITCH ······ C-4

PTO MONITOR LAMP ······ D-7

PTO ON/OFF SWITCH ······ C-4

PTO ROTATION TABLE ······ D-8

PTO SHIFT LEVER ······ C-18

R

READ SAFETY INSTRUCTION ······ B-2

REAR WINDOW ······ C-22

REARVIEW MIRRORS ······ C-23

RE-CIRCULATION INLETS FULLY

CLOSED ······ C-27

RECOMMENDED WATER QUALITY

STADARDS AND MAJOR TROUBLES FROM

PRRO WATER QUALITY ······ H-11

REGEN DISABLE SWITCH ······ C-6

REGEN REQ. SWITCH ······ C-6

REGENERATION ACTIVATE ······ D-9

REMOTE CONTROL LEVER ······ C-16

REQUIRED ENGINE COOLANT

CHARACTERISTICS ······ H-12

REUSE AFTER LONG TERM STORAGE ······ E-20

RIGHT SIDE OF THE TRACTOR ······ A-2

ROOF HATCH ······ C-28

ROPS ······ A-10

S

SAFE OPERATION OF YOUR TRACTOR ······ B-15

SAFETY DECALS ······ B-24

SAFETY INSTRUCTIONS ······ B-2

SAFETY PRECATIONS ······ B-1

SAFETY PRECATIONS WHEN USING

LOADER ······ B-10

SAFETY START ······ B-9

SAFETY TIPS DURING MAINTENANCE ······ B-16

SEAT ADJUSTMENT ······ A-12

SEAT BACK ANGLE, CUSHION STRENGTH

ADJUSTMENT ······ A-12

SEAT SLIDING ······ A-12

SENSITIVITY MODE SWITCH ······ C-5

SERVICE & PARTS ······ A-5



SERVICE PRIOR TO DAILY AND SHORT TERM STORAGE	E-19	TILT LEVER	C-14	USE OF TRACTOR WITH ROPS LOWERED CAN CAUSE FATAL INJURIES	A-10
SERVICE TRACTOR SAFELY	B-8	TIPS FOR DRIVING ON SLOPE	D-5		
SHIFTING AND DRIVING	D-4	TIRE PRESSURE	E-14	V	
SIGNAL SIGNS	B-2	TOWING SAFELY	B-12	VENTILATION	C-26
SPECIFICATION	H-2	TOWING THE TRACTOR	D-11		
SPEED CONTROL PEDAL (F/R)	C-12	TOWING WITH ENGINE OFF	D-12	W	
STANDARD FOR FARMWORK	G-2	TOWING WITH ENGINE RUNNING	D-11	WARRANTY OF THE PRODUCT	A-5
START & STOP OF ENGINE	D-2	TRACK ADJUSTMENT	E-14	WATER IN FUEL WARNING LAMP	C-10
START ON STEEP SLOPE	D-5	TRACTOR IDENTIFICATION	A-5	WINTER OPERATION WITH DIESEL FUEL	D-24
STARTING OFF	D-4	TRACTOR INSTRUMENTS	C-1	WIRING DIAGRAM OF THE ELECTRIC INSTRUMENTS	H-5
STAY CLEAR OF ROTATING SHAFTS	B-5	TRACTOR RUNAWAY	B-9	WORK IN VENTILATED AREA	B-8
STEERING WHEEL & HYDRAULIC SYSTEM TROUBLESHOOTING	F-6	TRAILER SOCKET	D-14	WORK PROCEDURES	D-15
STOPPING ENGINE	D-3	TRANSMISSION OIL CHANGE	E-7	WORKING LAMP, WIPER, WASHER CONTROL PANEL	C-25
STORING THE TRACTOR	E-19	TRANSMISSION OIL CHECK	E-7	WORKING LAMPS	C-22
SUB SHIFT LEVER	C-13	TRANSPORT TRACTOR BY TRUCK	B-12		
SWITCHES	C-2	TRAVELING SPEED	H-5		
		TROUBLESHOOTING	F-1		
T		TURN SIGNAL LAMPS	C-8		
TACHO METER	C-8	TURNING IN FIELD	D-4		
TELESCOPIC STABILIZERS		TYPE OR NUMBER OF ENGINE & CHASSIS	A-5		
ADJUSTMENT	C-18	TYPICAL PROPERTIES OF LLC (YANMAR STANDARD)	H-12		
THE FOLLOWING PRECAUTIONS ARE SUGGESTED TO HELP PREVENT ACCIDENTS	B-18				
THREE POINT LINKAGE	C-17	U			
THROTTLE LEVER	C-13	UNIVERSAL SYMBOLS	B-29		
		USE OF HAZARDOUS SUBSTANCES	B-13		
		USE OF ROPS AND SEAT BELT	B-3		



T455 / T555 (NH, SH)

OPERATOR'S MANUAL FOR TYM TRACTORS

⚠ ALL INFORMATION, ILLUSTRATIONS AND SPECIFICATIONS IN THIS MANUAL ARE BASED ON LATEST INFORMATION AVAILABLE AT THE TIME OF PUBLICATION. THE RIGHT IS RESERVED TO MAKE CHANGES AT ANY TIME WITHOUT A NOTICE.

221124

PART NO.
1177-940-001-0