





FOREWORD

- █ Thank you very much for purchasing our tractor which will give you many years of reliable service.
- █ The introduction in this manual sets out the correct manner of operating, maintaining and checking the tractor to ensure long-term durability.
- █ Please ensure correct operation of the tractor as incorrect can cause substantial mechanical damage as well as cause accidents with the associated injuries.
- █ Please note that in some cases differences can exist between this manual and your tractor due to the manufacture's policy of constant product improvement.
- █ In the event that you encounter a problem not covered by this manual, please contact your nearest dealer who will assist you in resolving your problem.

**TYM**

WARNING SIGNS

The following warning signs in this manual draw additional attention to items of importance for the safe and correct operation of the tractor.

SIGNS	MEANING OF THE SIGN
	This indicates that a condition may result in harm, serious injury or death to you or other persons if the warning is not heeded. Follow the advice provided with the warning signs.
	Hazard or unsafe practice that can lead to severe injury or death.
	Hazard or unsafe practice that can lead in injury or death.
	Instructions for the correct operation of the machine which, if followed, will ensure that it performs at its best.

All information, illustrations and specifications in this manual are based on latest information available at the time of publication. The right is reserved to make change at any time without a notice.

TABLE OF CONTENTS

A. GENERAL INFORMATION

A

B. SAFETY PRECAUTIONS

B

C. TRACTOR INSTRUMENTS

C

D. OPERATION

D

E. MAINTENANCE

E

F. TROUBLESHOOTING

F

G. STANDARD FOR FARMWORK

G

H. APPENDIX

H

I. INDEX

I

TABLE OF CONTENTS

A GENERAL INFORMATION

1. EXTERIOR VIEW A – 2
2. TRACTOR IDENTIFICATION A – 9
3. ABOUT THIS MANUAL A – 10
4. INTRODUCTION & DESCRIPTION A – 11
5. OWNER ASSISTANCE A – 13
6. ROPS (ROLL OVER PROTECTIVE
STRUCTURES) A – 14
7. SEAT ADJUSTMENT A – 16

B SAFETY PRECAUTIONS

1. SAFETY INSTRUCTIONS B – 2
2. SAFE OPERATION OF TRACTOR B – 15
3. DOs & DON'Ts B – 22
4. SAFETY DECALS B – 24
5. UNIVERSAL SYMBOLS B – 30

C TRACTOR INSTRUMENTS

1. SWITCHES C – 2
2. MONITOR PANEL & GAUGES C – 6
3. CONTROL INSTRUMENTS C – 13
4. THREE POINT LINKAGE C – 24
5. CABIN C – 29

D OPERATION

1. START & STOP OF ENGINE D – 2
2. OPERATING THE TRACTOR D – 4
3. OPERATION OF PTO D – 7
4. OPERATION OF DPF D – 9
5. IMPLEMENTS D – 11
6. TOWING THE TRACTOR D – 13
7. CHECKS DURING DRIVING D – 15
8. WORK PROCEDURES D – 17
9. OPERATION TIPS D – 23
10. HOW TO USE OF JACKS D – 28

E

MAINTENANCE

- 1. MAINTENANCE SCHEDULE..... E – 2
- 2. OPENING COVERS E – 4
- 3. CHECKS & SERVICING EACH PART..... E – 5
- 4. GREASING EACH PART E – 21
- 5. STORING THE TRACTOR E – 22

F

TROUBLESHOOTING

- 1. ENGINE TROUBLESHOOTING F – 2
- 2. CLUTCH TROUBLESHOOTING F – 5
- 3. BRAKE TROUBLESHOOTING F – 5
- 4. STEERING WHEEL TROUBLESHOOTING · F – 6
- 5. HYDRAULIC SYSTEM
TROUBLESHOOTING F – 6
- 6. ELECTRIC INSTRUMENTS
TROUBLESHOOTING F – 7
- 7. AIR CONDITIONER TROUBLESHOOTING · F – 8

G

STANDARD FOR FARMWORK

- 1. STANDARD FOR FARMWORK..... G – 2

H

APPENDIX

- 1. SPECIFICATIONS H – 2
- 2. MAJOR CONSUMABLES H – 6
- 3. NOISE LEVELS H – 7
- 4. VIBRATION REFERRED TO THE
OPERATOR POSITION H – 8

TABLE OF CONTENTS

I INDEX

1. INDEX.....	- 2
---------------	-----



A. GENERAL INFORMATION

1. EXTERIOR VIEW ······ A – 2
2. TRACTOR IDENTIFICATION ······ A – 9
3. ABOUT THIS MANUAL ······ A – 10
4. INTRODUCTION & DESCRIPTION ······ A – 11
5. OWNER ASSISTANCE ······ A – 13
6. ROPS (ROLL OVER PROTECTIVE
STRUCTURES) ······ A – 14
7. SEAT ADJUSTMENT ······ A – 16

1. EXTERIOR VIEW

▶ RIGHT SIDE OF THE TRACTOR (REAR ROPS)



▶ LEFT SIDE OF THE TRACTOR (REAR ROPS)



A

▶ **RIGHT SIDE OF THE TRACTOR (FRONT ROPS)**



▶ LEFT SIDE OF THE TRACTOR (FRONT ROPS)

A



► **RIGHT SIDE OF THE TRACTOR (CABIN)**



▶ LEFT SIDE OF THE TRACTOR (CABIN)

A



► **BACK SIDE OF THE TRACTOR (CABIN)**

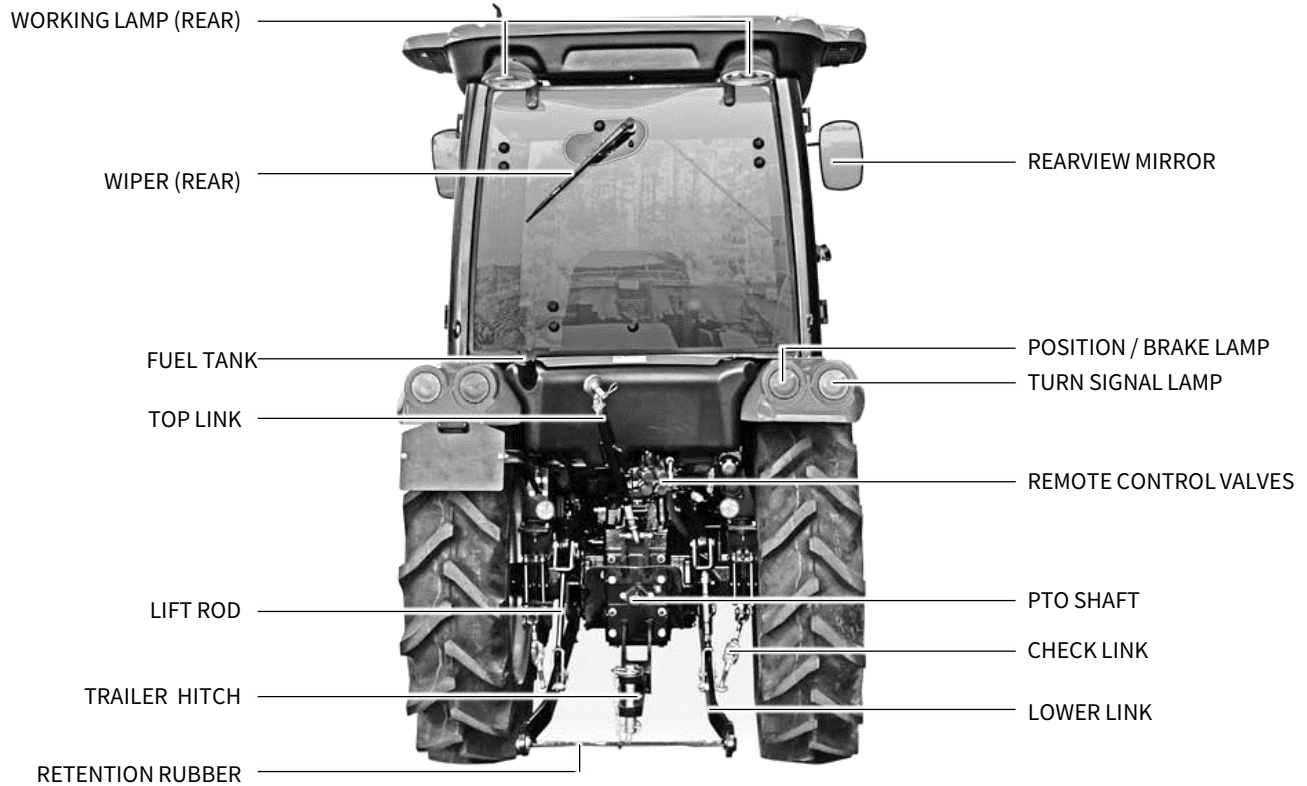

2. TRACTOR IDENTIFICATION

▶ TYPE OR NUMBER OF ENGINE & CHASSIS

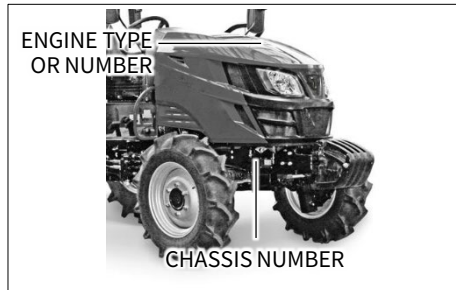

The engine and chassis number are stamped as shown in the drawing above.

▶ WARRANTY OF THE PRODUCT

The manufacturer warrants this product and full details of the warranty are provided on a separate warranty schedule.

▶ SERVICE & PARTS

• SERVICE

Service is available from any TYM dealer in the country.

• PARTS

To obtain spare parts please contact your nearest dealer and give him the details listed below.

- Tractor model
- Tractor serial number
- Tractor engine number
- Part number and description
- Quantity required

A



3. ABOUT THIS MANUAL

This manual has been prepared to assist you in following/adopting the correct procedure for running-in operation and maintenance of your new TYM CO., LTD tractor.

Your tractor has been designed and built to give maximum performance, with good fuel economy and ease of operation under a wide variety of operating conditions.

Prior to delivery, the tractor was carefully inspected, both at the factory and by your TYM Dealer/Distributor, to ensure that it reaches you in optimum conditions.

To maintain this condition and ensure trouble free performance, it is important that the routine services, as specified in this manual, are carried out at the recommended intervals.

Read this manual carefully and keep it in a convenient place for future reference.

If at any time you require advice concerning your tractor, do not hesitate to contact your authorized TYM dealer / distributor.

He has trained personnel, genuine parts and necessary equipment to undertake all your service requirements.

Manufacturer's policy is one of continuous improvement, and the right to change prices, specifications or equipment at any time without notice is reserved.

All data given in this book is subject to production variations.

Dimensions & weight are approximate only and the illustrations do not necessarily show tractors in standard condition.

For exact information about any particular tractor, please consult your TYM dealer / distributor.

4. INTRODUCTION & DESCRIPTION

The word, 'tractor' has been derived from 'traction' which means pulling. A tractor is required to pull or haul an equipment, implement or trolley which are coupled to the tractor body through suitable linkage.

A tractor can also be used as a prime mover as it has a power outlet source which is also called Power Take or PTO shaft.

In this book the operating, maintenance and storage instructions for all models of TYM diesel tractors has been complied. This material has been prepared in detail to help you in the better understanding of maintenance and efficient operation of the machine.

If you need any information not given in this manual, or require the services of a trained mechanic, please get in touch with the TYM dealer / distributor in your locality.

Dealer / distributors are kept informed of the latest methods of servicing tractors.

They stock genuine spare parts and are backed by the company's full support.

Through this manual, the use of the terms LEFT, RIGHT, FRONT and REAR must be understood, to avoid any confusion when following the introductions.

The LEFT and RIGHT means left and right sides of the tractor when facing forward in the driver's seat, reference to the FRONT indicates the radiator end of the tractor, while the REAR, indicates the drawbar end.

When spare parts are required, always specify the tractor and engine serial number when ordering these parts. This will facilitate faster delivery and help ensure that the correct parts for your particular tractor is received.

The tractor serial number is punched on a plate attached to the left hand side of the engine body.

For easy reference, we suggest you to write the number in the space provided in the owner's personal data.

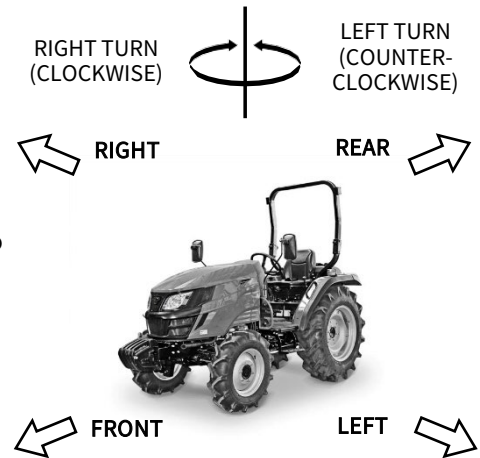



► DESCRIPTION

• GENERAL CONSTRUCTION

The transmission case, clutch, clutch housing, engine and front axle support are bolted together to form a rigid unit.

• FRONT AXLE & WHEEL

The 4WD front axle is a center-pivot, reverse eliot type.

The front wheel drive mechanism is incorporated as a part of the axle.

The front wheel drive power is taken off the rear transmission and transmitted to the differential in the front axle where the power is divided into right and left and to the respective final cases.

In the final cases, the transmitted revolution is reduced by the level gears to drive the front wheel.

The 4WD mechanism with level gears provides wider steering and greater durability.

• ENGINE

The tractors are fitted with vertical, water-cooled 4-cycle and spherical chamber type YANMAR ENGINES.

• CLUTCH AND TRANSMISSION

A single plate dry clutch (8.86" diameter) is used on these tractors.

Tractor with IPTO (Independent Power Take Off) are fitted with hydraulic Clutch Assy.

The transmission Gear box has Twelve forward speeds & Twelve reverse speeds with high-low selector lever, presently, TYM tractors are fitted with partial synchro-mesh type gears.

• BRAKES

TYM tractors are provided with independent disc brakes operated by two brake rods' movement.

Use parking brake lever in case of parking the tractor.

• REAR AXLE & WHEELS

This is mounted on ball bearings and is enclosed in removable housing which are bolted to the transmission case.

The rim & disc fitted with rear tires are bolted to the outer flange of rear axle.

• HYDRAULIC SYSTEM & LINKAGES

TYM tractors are fitted with live independent, very touch of hydraulic system.

Three point linkages can be used for category 1 type of implements.

• STEERING

It consists of hydrostatic power steering system, which has a hydraulic cylinder and tandem type hydraulic pump.

5. OWNER ASSISTANCE

• ELECTRICAL SYSTEM

A 12 volt lead acid propylene battery is used to activate the engine through the starter motor and the electrical system comprising horn, head lamp. Side indicator lamps, plough lamp, brake light, gauge lamp, hazard lamp. Generator or alternator, fuse box also from part of the electrical system.

WARNING

- When operating the tractor at high speed, do not attempt to make sharp turns by using the brakes. This may result in overturning of the tractor causing serious injury or death.

We at TYM and your TYM dealer / distributor want you to be completely satisfied with your investment.

Normally any problems with your equipment will be handled by your dealer / distributor's service departments, however, misunderstanding can occur.

If you feel that your problem has not been handled to your satisfaction, we suggest the following.

Contact the owner or general manager of the dealership, explain the problem, and request assistance.

When additional assistance is needed, your dealer / distributor has direct access to your office.

If you cannot obtain satisfaction by doing this, contact the TYM office and provide us with;

- Your name, address and telephone number
- Model and tractor serial number
- Dealer / distributor name & address
- Machine purchase date and Hours used
- Nature of problem

Before contacting TYM office, be aware that your problem will likely to be resolved in the dealership using the dealer's / distributor's facilities, equipment and personnel.

So it is important that your initial contact be with the dealer / distributor.

6. ROPS (ROLL OVER PROTECTIVE STRUCTURE)

► ROPS

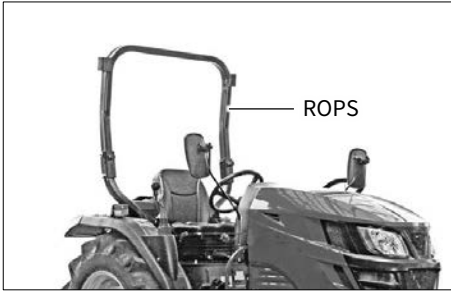

TYM tractors are equipped with a frame for the protection of operators. In the case of cab tractors the frame is incorporated in the cab structure. The objective of the frame or cab structure is to protect the operator in the event of a roll over and they are designed to support the entire weight of the tractor in that event.

Each TYM ROPS frame or cab structure is designed and has been tested to meet industry and or government standards. Included in these tests were all mounting bases and bolts or other fasteners.

On some models the ROPS frame has a fold down feature, which can be used to enter low buildings etc.

Take care when lowering the upper section of the ROPS frame and take extreme care while driving the tractor with the ROPS frame lowered.

Do not wear the seat belt with the ROPS lowered and please remember that the fold down facility is for special circumstances only and must not be lowered for general use.

DANGER

- For ROPS frames to be effective and protect the operator, the seat belt provided must be worn in order to keep operators within the ROPS protected area in the event of a roll over. Failure to use the seat belt can still cause serious injury or death.

► **USE OF TRACTOR WITH ROPS LOWERED CAN CAUSE FATAL INJURIES**

As the ROPS frame or cab together with the seat belt was designed to meet certain standards, they must be maintained in good order and condition. To achieve this objective, both the structure and the seat belt should be inspected on a regular basis. (Every time the tractor is serviced)

In the event that the seat belt is damaged or frayed, it should be replaced and in the event that the ROPS frame or any part of the mounting structure is damaged or cracked, the faulty component must be replaced with a new unit.

Such a unit must meet all of the test criteria of the original unit. Fitment of an inferior item or items affects the certification of the entire ROPS structure and the effectiveness of the structure in the event of an accident. Drilling or welding of the ROPS is forbidden.

► **DAMAGE OF ROPS**

If the tractor has rolled over or the ROPS has damaged (such as striking an overhead object during transport), it must be replaced to provide the original protection.

After an accident, check for damages to

- **ROPS**
- **SEAT**
- **SEAT BELT & SEAT MOUNTINGS**

Before you operate a tractor, replace all damaged parts.

 **WARNING**

- Do not weld, drill or straighten the ROPS.
- Always wear your seat belt if the tractor is equipped with ROPS.

 **WARNING**

- If the ROPS is removed or replaced, make certain that the proper hardware is used to replace the ROPS and the recommended torque values are applied to the attaching bolts.

 **WARNING**

- Never attach chains, ropes to the ROPS for pulling purposes. This will cause the tractor to tip backwards. Always pull from the tractor drawbar.
- Be careful when driving through door opening or under low overhead objects. Make sure there is sufficient overhead clearance for the ROPS fatal injuries.

 **WARNING**

- Always wear your seat belt if the tractor is equipped with ROPS.

► **ROPS (REAR)**



A

► **ROPS (FRONT)**



7. SEAT ADJUSTMENT

▶ SEAT SLIDING

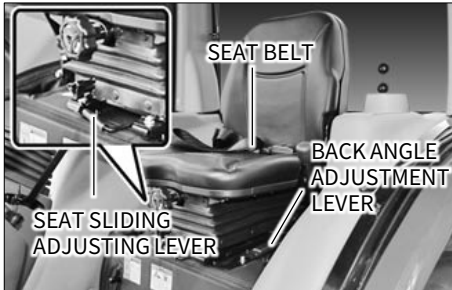

Before operating a tractor it is important to adjust the seat to the most comfortable position & check whether it is properly locked in its position.

⚠ IMPORTANT

- Do not use solvents to clean the seat. Use warm water with a little detergent added.

⚠ WARNING

- Do not put a hand between the seat and the slides when adjusting the seat position. You can get injured unexpectedly.

To select seat position, move adjusting lever and slide seat closer to or away from dash panel and controls.

⚠ DANGER

- Check whether the seat properly locked in its position before driving the tractor.
- Always use the seat belt when the ROPS is installed.
- Do not use the seat belt if a foldable ROPS is down or there is no ROPS. Check the seat belt regularly and replace if frayed or damaged.

▶ CUSHION STRENGTH ADJUSTMENT

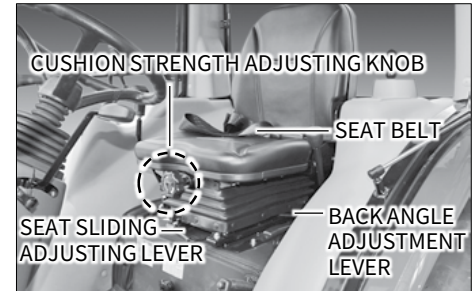

The seat cushion can be adjusted according to the weight of the driver.

Turning the cushion adjustment knob counterclockwise to the 50kg position makes the cushion lighter, and turning the lever clockwise to the 130kg position makes the cushion heavier.

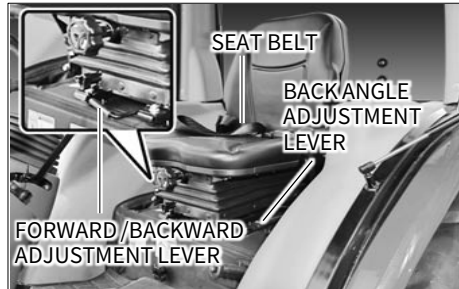
▶ SEAT BACK RECLINING

To change the seatback angle, raise The lever on the left of the seat.

Then, adjust the seatback angle with The lever pulled. Release the lever

After adjustment . Make sure that the Lever is returned and the seat is firmly fixed after adjustment.

A

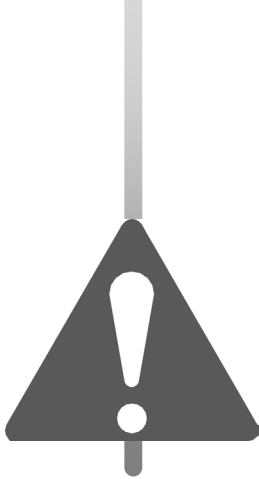

B. SAFETY PRECAUTIONS

1. SAFETY INSTRUCTIONS B – 2
2. SAFE OPERATION OF TRACTOR B – 15
3. DOs & DON'Ts B – 22
4. SAFETY DECALS B – 24
5. UNIVERSAL SYMBOLS B – 30

SAFETY PRECAUTIONS

1. SAFETY INSTRUCTIONS

► ENSURE SAFETY INFORMATION



This symbol means

‘Attention! Your safety is involved.’

The message that follows the symbol contains important information about safety.

Carefully read the message.

► SIGNAL SIGNS



The signal signs

‘DANGER, WARNING or CAUTION’

are used with safety alert symbol.

DANGER identifies the most serious hazards.

Safety symbols with signal signs ‘DANGER or WARNING’ are typically near specific hazards.

General precautions are listed on CAUTION safety signs.

► READ SAFETY INSTRUCTION

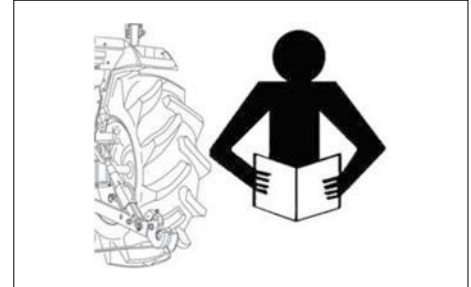

Carefully read all safety instructions given in this manual for your safety.

Tempering with any of the safety devices can cause serious injuries or death.

Keep all safety signs in good condition. Replace missing or damaged safety signs.

Keep your tractor in proper condition and do not allow any unauthorized modifications to be carried out on the tractor, which may impair the function / safety and affect tractor life.

► PROTECT CHILDREN



Keep children and others away from the tractor while operating.

Before you reverse

- Look behind tractor for children.
- Do not let children to ride on tractor or any implement.

► USE OF ROPS AND SEAT BELT



The Roll Over Protective Structure (ROPS) has been certified to industry and / or government standard.

Any damage or alternation to the ROPS, mounting hardware or seat belt voids the certification and will reduce or eliminate protection for the operator in the event of a roll-over.

The ROPS, mounting hardware and seat belt should be checked after the first 100 hours of use and every 500 hours thereafter for any evidence of damage, wear or cracks.

In the event of damage or alternation, the ROPS must be replaced prior to further operation of the tractor.

The seat belt must be worn during machine operation when the machine is equipped with a certified ROPS.

Failure to do so will reduce or eliminate protection for the operator in the event of a roll-over.

▶ PRECAUTION TO AVOID TIPPING

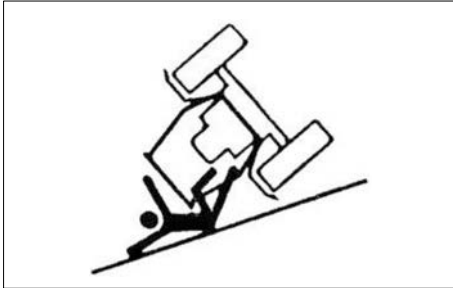

Do not drive where the tractor could slip or tip.
Stay alert for holes and rocks in the terrain and other hidden hazards.

Slow down before you make a sharp turn.

Driving forward out of a ditch or mired condition could cause tractor to tip over backward.

Back out of these situations if possible.

▶ PARK TRACTOR SAFELY

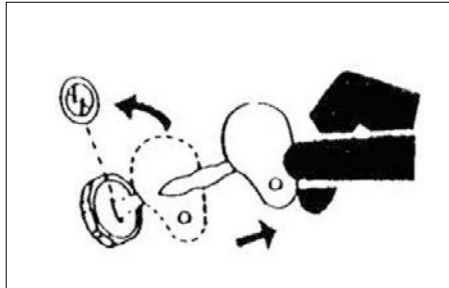

Before working on the tractor:

- Lower all equipment to the ground.
- Stop the engine and remove the key.

▶ KEEP RIDERS OFF TRACTOR



Do not allow riders on the tractor.

Riders on tractor are subject to injury such as being stuck by foreign objects and being thrown off of the tractor.

▶ HANDLE FUEL SAFELY TO AVOID FIRE



Handle fuel with care.
It is highly flammable.

Do not refuel the tractor while smoking or near open flame or sparks.

Always stop engine before refueling tractor.

Always keep your tractor clean of accumulated grease and debris.
Always clean up spilled fuel.

▶ STAY CLEAR OF ROTATING SHAFTS



Entanglement in rotating shaft can cause serious injury or death.

Keep PTO shield in place at all the time.

Wear fitting clothing.

Stop the engine and be sure PTO drive is stopped before making adjustments, connections or cleaning out of PTO driven equipment.

▶ ALWAYS USE SAFETY LIGHTS AND DEVICES

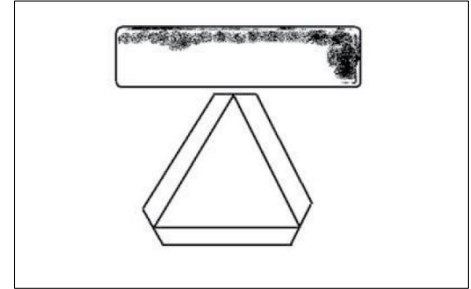

Use of hazard warning lights and turn signals are recommended when towing equipment on public roads unless prohibited by state or local regulations.

Use slow moving vehicle(SMV) sign when driving on public road during both day& night time unless prohibited by law.

► PRACTICE SAFE MAINTENANCE



Understand service procedure before doing work.

- Keep the surrounding area of the tractor clean and dry.
- Do not attempt to service tractor when it is in motion.
- Keep body and equipment to the ground.
- Stop the engine.
- Remove the key.
- Allow tractor to cool before any work repair is caused on it.
- Securely support any tractor elements that must be raised for service work.

- Keep all parts in good condition and properly installed.
- Replace worn or broken parts.
- Replace damaged / missing decals.
- Remove any build-up of grease or oil from the tractor.
- Disconnect battery ground cable ⊖ before making adjustments on electrical systems or welding on tractor.

► AVOID HIGH PRESSURE FLUIDS



Escaping fluid under high pressure can penetrate the skin causing serious injury.

Keep hands and body away from pin holes and nozzle which eject fluids under high pressure.

If any fluid is injected into the skin, consult your doctor immediately.

▶ PREVENT BATTERY EXPLOSION

Keep sparks, lighted matches and open flame away from the top of battery. Battery gas can explode.

Never check battery charge by placing a metal object across the poles.

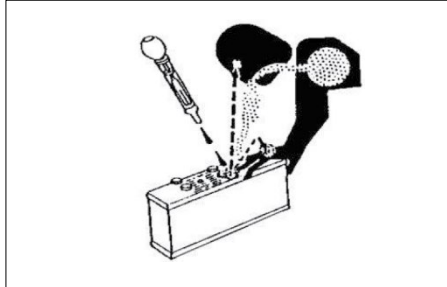
▶ PREVENT ACID BURNS

Sulfuric acid in battery electrolyte is poisonous. It is strong enough to burn skin, cause holes in clothing and cause blindness if found entry into eyes.

For adequate safety always:

- Fill batteries in a well-ventilated area.
- Wear eye protection and acid proof hand gloves.
- Avoid breathing direct fumes when electrolyte is added.
- Do not add water to electrolyte as it may splash off causing severe burns.

If you spill acid on yourself:

1. Flush your skin or eyes with water for 10 ~ 15 minutes.
2. Get medical attention immediately.

▶ BATTERY DISCONNECTION

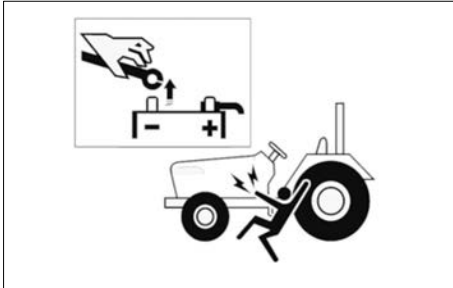

When working with your tractor electrical components, you must first disconnect the battery cables.

To ensure that there are no accidents from sparks, you must first disconnect the negative battery cable.

▶ SERVICE TRACTOR SAFELY

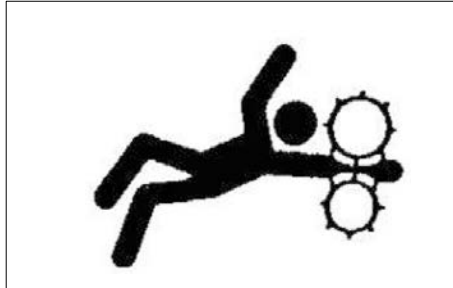

Do not wear a necktie, scarf or loose clothing when you work near moving parts.

If these items were to get caught, severe injury could result.

Remove rings and other jewelry to prevent electrical shorts and entanglement in moving parts.

▶ WORK IN VENTILATED AREA

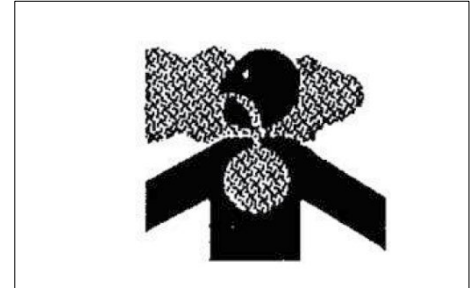

Do not start the tractor in an enclosed building unless the doors & windows are open for proper ventilation as tractor fumes can cause sickness or death.

If it is necessary to run an engine in an enclosed area remove the exhaust fumes by connecting exhaust pipe extension.

► **TRACTOR RUNAWAY**

Engine start with transmission engaged can cause tractor to runaway resulting serious injury to the people standing nearby the tractor.

For additional safety keep the pull to stop knob (fuel shut off control) in fully pulled out position.

Transmission in neutral position, foot brake engaged and PTO lever in disengaged position while attending to Safety Starter Switch or any other work on tractor.

► **SAFETY START**

1. Clutch operated safety switch is provided on all tractors which allow the starting system to become operational only when the clutch pedal is fully pressed.
2. Do not by-pass this safety starter switch or work on it. Only authorized dealers are recommended to work on safety starter switch.
3. On some models safety starter switch is provided on transmission high-low shifter lever and in PTO shifter lever. The tractor can be started only if high-low shifter lever is in neutral position.

 **CAUTION**

- Safety Starter Switch is to be replaced after every 2,000 hours/4 years, whichever is earlier.

► **EMERGENCY EXITS**

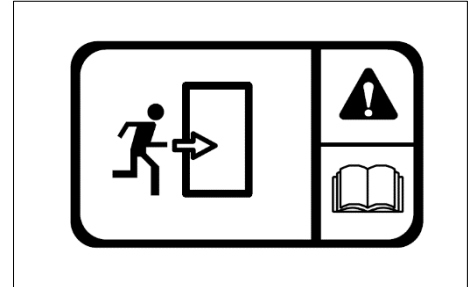

If exit from the cab side doors is blocked (following an accident or vehicle overturn) the alternative safety exits are indicated by decals.

The possible safety exits are:

- Rear window hatch (All tractors)
- Front window (for versions with openable front window).

► SAFETY PRECAUTIONS WHEN USING LOADER

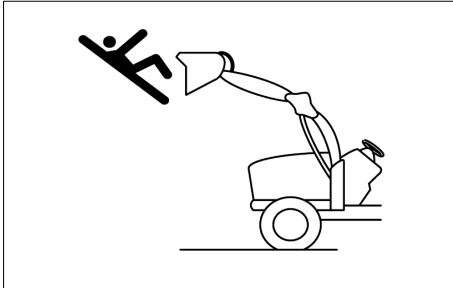

Never let anyone get in the loader and use the loader as a workbench. Otherwise, it may lead to a fatal injury or even death.

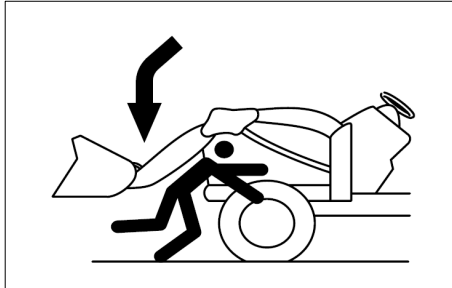

Do not stand under the lifted loader or get close to it. Also, lower the loader arm onto the ground before leaving the tractor. Otherwise, it may lead to a fatal injury or even death.

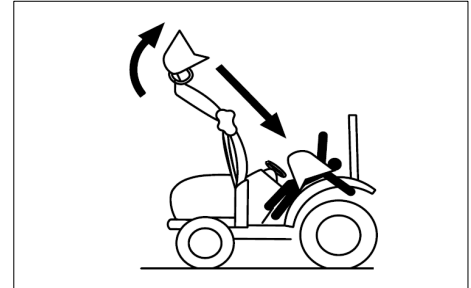

When attaching or detaching the loader, fix all parts which are connected to the bucket and boom. The bucket or boom can be accidentally dropped down, leading to an injury or even death.



Be careful of objects falling from loader.

+ **IMPORTANT**

- ROPS (Roll Over Protective Structure), sun canopy or cabin are not a FOPS (Falling Object Protective Structure). It never can protect the riders against falling objects. Avoid driving the vehicle into a dangerous area such as falling rocks zone.

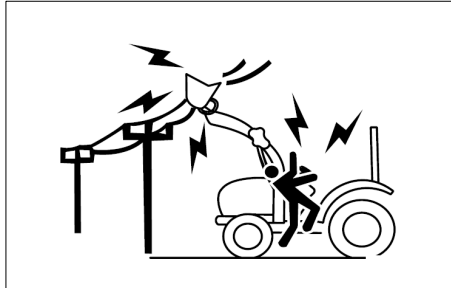

Do not allow loader arms or attachment to contact electrical power lines. Electrocutation will cause serious injury or death.

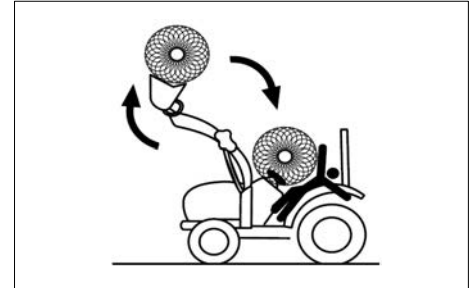

Never carry a big object with the loader unless a proper implement is attached.

Keep a carried object low during driving.

Otherwise, it may lead to an injury or even death.

► TOWING SAFELY

For the maximum towable loads, refer to the 'TIRE AND MASS' section in appendix chapter if available. Maintain a suitable speed taking into account the weight of the trailed load and the gradient, remembering that braking distances will be greater than with just the tractor. Trailled loads with or without brakes that are too heavy for the tractor or that towed at too high speed may cause the operator to lose control of the tractor. Always take into consideration the total weight of the implements and their loads. When trailers are hitched to the tractor, before you leave the operator seat remember to put all the controls in neutral, apply the handbrake, switch off the engine, engage first gear (with mechanical transmissions) and remove the ignition key. Always chock both the tractor and the trailer wheels. The best way to transport a tractor that has broken down is to transport it on a low loader.

Always secure the tractor to the loader bed with chains. Before transporting the tractor on a low loader or on a railway wagon, make sure that the engine hood, doors, openable roof (if present) and windows are all closed and securely fastened. Never tow the tractor at speeds in excess of 10 km/h. An operator must stay in the operator position to steer and brake the tractor.

CAUTION

- When a trailer is hitched to the tractor, before you leave the driving seat remember to put all the controls in neutral, apply the handbrake, switch off the engine, engage first gear (if the tractor has a mechanical transmission) and remove the key from the starter switch. If the tractor is not parked on level ground, always place chocks under the wheels of both the tractor and the trailer. For further information on safe working procedures, refer to the chapter "Parking the tractor" in the safe section of this manual.

► TRANSPORT TRACTOR BY TRUCK

Always secure the tractor to the loader bed with chains.

Before transporting the tractor on a low loader or on a railway wagon, make sure that the engine hood, doors, openable roof (if present) and windows are all closed and securely fastened.

Never tow the tractor at speeds in excess of 10 km/h.

An operator must stay in the operator position to steer and brake the tractor.

► FALLING OBJECT PROTECTIVE STRUCTURE (FOPS)

The term FOPS refers to structure installed on the tractor intended to reduce the risk to the operator of injury from falling objects during normal use of the vehicle

⊕ IMPORTANT

- This tractor is not equipped with a FOPS.
- The energy level of drop test is 1365J.

► OPERATOR PROTECTIVE STRUCTURE (OPS)

The term OPS refers to a protective structure installed on a tractor in order to minimize risk of operator injury caused by objects penetrating into the operator position area.

⚠ DANGER

- This tractor is not equipped with an OPS. If work must be performed in areas subject to the risk of the penetration of objects into the operator position, consult your dealer before starting work so that the tractor can be equipped with an appropriate protective structure.

► USE OF HAZARDOUS SUBSTANCES

European standard EN 15695-1 is applicable to the cabs of agricultural or forestry tractors and self-propelled sprayers.

The purpose of the standard is to limit the exposure of the operator (driver) to hazardous substances when applying plant protection products and liquid fertilizers.

In accordance with the stipulations of EN 15695-1 regarding cab classification, measurement of the internal positive pressure differential must be carried out in conformance with ISO 14269-5:

- The engine operating at nominal speed;
- The maximum quantity of air drawn from outside the cab (recirculation closed);
- Fan set to maximum speed.

The following terms and definitions are applied:

- Hazardous substances: substances such as dust, vapours and aerosols, with the exception of fumigants which can be dispersed during the application of plant protection products and liquid fertilizers, which may have a harmful effect on the operator.
- Dust general term identifying solid air-borne particles, finely divided and accumulated.
- Aerosol: suspension of solid, liquid or solid and liquid particulate in a gaseous medium with a negligible fall rate (generally less than 0.25 ms⁻¹)
- Vapour: gaseous phase of a substance whose liquid or solid state is stable at 20°C and 1 bar (absolute).
This cab, even when closed, does not protect against the inhalation of hazardous substances.

If the manufacturer's instructions for using these substances recommend personal protective equipment, wear the equipment even in the cab.

Cabs are classified as follows:

- Category 1: the cab does not provide protection against hazardous substances.
- Category 2: the cab provides protection exclusively from dust.
- Category 3: the cab provides protection from dust and aerosol.
- Category 4: the cab provides protection from dust, aerosol and chemical vapours.

The classification category, as stipulated

by ISO 14269-5, of the cab installed on this range of tractors is given below:

- the engine operating at nominal speed
- the maximum quantity of air drawn from outside the cab (recirculation closed) with fan at maximum speed.

Table 2 – Technical data

CABIN / ROPS	CATEGORY
Hazardous substances protection category	1

DANGER

- Use all the personal protective equipment suitable for the tasks in hand and relative substances, in compliance with the requirements of statutory legislation in your country.

2. SAFE OPERATION OF YOUR TRACTOR

The manufacturer of your tractor has made every effort to make it as safe as is humanly possible.

Beyond this point it is the responsibility of the operator to avoid accidents and we ask that you read and implement our suggestions for your safety.

Ensure that only trained and competent operators use this tractor and ensure that they are fully conversant with the machine and aware of all its control and safety features.

Operators should not operate the tractor or associated machinery while tired or untrained.

To avoid accidents please ensure that the operator wears clothing which will not get entangled in the moving parts of the tractor or machine and protect him or her from the elements.

When spraying or using chemicals, please ensure that clothing and protective equipment is worn which prevents respiratory or skin problems.

For full details consult the manufacturer of the chemicals.

To avoid lengthy exposure to noise ensure that ear protection is worn.

If adjustment to the tractor or machinery need to be made ensure the tractor or machine are turned off beforehand.

Use of certified Roll Over Protection Structure (ROPS) is a must while operating a tractor.

Use of seat belt is a must while operating a tractor.

In summary, ensure at all times that the safety of the operator and any other worker is paramount.

Ensure no one is between the tractor and a towed vehicle (trailer or implement).

► SAFETY TIPS DURING MAINTENANCE

1. At least on a daily basis check all oil levels. Water level in the radiator and electrolyte level in the battery and perform services according to the service schedule.
2. Ensure tire pressure are even and the correct pressure for the job being done is maintained.
3. Check to ensure that the all controls and preventative mechanisms of the tractor and implement work correctly and effectively.
4. Ensure that an adequate set of the correct tools is available for maintenance and minor repairs.
5. Ensure that all service work and repairs are carried out on a flat area with a concrete or similar floor. Do not carry out service work on a tractor until it is switched off, and the parking brake applied and wheels chocked. Where a tractor is started in a confined area, ensure that the area is well ventilated as exhaust gases are very harmful, and can cause death.
6. Do not work under raised implements.
7. When changing wheels or tires ensure that a suitable wheel stand is placed under the axle prior to removing the wheel and the wheels are chocked.
8. Where guards or shields need to be removed to perform a service or repair, ensure that the guard or shield is correctly reinstalled before starting the tractor.
9. Never refuel near a naked flame or with an overheated engine. Ensure to turn off Engine before refueling.
10. The cooling system operates under pressure, take care when removing the radiator cap on a hot engine to prevent being scalded by steam or hot water. Do not add water in the radiator when the engine is hot. Add water to the radiator only after the engine cools down completely.
11. To prevent fires keep the tractor including the engine clean and free from inflammable material and well away from fuels and other inflammable material.

► MOUNTING AND DEMOUNTING IMPLEMENTS

1. Ensure that all mounting and removal of implements is done on safe flat ground. Ensure no one is between the tractor and implement and do not get under the implement to avoid accidental injuries.
2. After mounting the implement, ensure that all sway chains are correctly adjusted and, where PTO shafts are used that the shaft is fitted and secured correctly.
3. Where heavy implements are used, ensure that the combination is well balanced or use proper ballast to achieve balance.
4. Before leaving the tractor at any time, lower the implement, stop the PTO shaft where applicable, set the parking brake and switch off the engine.
5. While operating the implements with the PTO keep all bystanders away from any moving parts and do not attempt to make adjustments while the machine is running.
6. Only the driver should ride on the tractor with the ROPS frame fitted and with the seat belt properly fastened.
7. Where young children are present, particular care should be taken and the tractor should not be moved until the whereabouts of all children is known.
8. Only trained operators should operate the tractor and so taking care to ensure that other workers are not injured. In particular they should take care during dusty operations, which will reduce visibility substantially.
9. Never start the tractor unless the transmission is out of gear, the operator is in the seat and all round safety has been checked.
10. Only operate the tractor seated in the driver's seat and never turn or brake suddenly at high speed as this can cause a roll-over and serious injury or death.
11. When traveling on a public road ensure that the tractor and driver both meet all laws relating to safety and licensing. When traveling with wide implements use red flags on the extremities and observe all legal including escort requirements.
12. When operating under adverse conditions, hilly terrain or on bad ground adjust the speed of the tractor to suit the conditions, safety

comes first.

Never drive down-hill at high speed or with the transmission in neutral. Use of the braking capacity of the engine as well as the service brakes. Do not try to change gear going up or down a steep slope, select the correct gear before starting.

13. Take care when traveling uphill with a heavy implement to ensure that it does not overbalance and tip up the front end.
14. Never remove or modify the seat belt.
15. Never remove, modify or repair the ROPS frame.

Please remember that a little bit of extra care can prevent serious injury or death and avoid damage to your tractor.

► THE FOLLOWING PRECAUTIONS ARE SUGGESTED TO HELP PREVENT ACCIDENTS

A careful operator is the best operator.

Most accidents can be avoided by observing certain precautions.

Read and take the following precautions before operating the tractor to prevent accidents.

Tractor should be operated only by those who are responsible and properly trained to do so.

<THE TRACTOR>

1. Read the operator's manual carefully before using the tractor. Lack of operating knowledge can lead to accidents.
2. Use an approved rollover bar and seat belt for safe operation. Overturning of a tractor without a rollover bar can result in death or injury.
3. Do not remove ROPS (Roll Over Protective Structure). Always use the seat belt.
4. Fiberglass canopy does not give any

protection.

5. To prevent falls, keep steps and platform clear of mud and oil.
6. Do not permit anyone but the operator to ride on the tractor. There is no safety place for extra riders.
7. Replace all missing, illegible or damaged safety signs.
8. Keep safety signs clean of dirt and grease.

<SERVICING THE TRACTOR>

1. keep the tractor in good operating condition for your safety. An improperly maintained tractor can be hazardous.
2. Stop the engine before performing any service on the tractor.
3. The cooling system operates under pressure, which is controlled by the radiator cap. It is dangerous to remove the cap while the system is hot.

First turn the cap slowly to stop and allow the pressure to escape before removing the cap entirely.

4. Do not smoke while the refueling the tractor.
Keep away any type of open flame.
5. The fuel in the injection system is under high pressure and can penetrate the skin.
Unqualified persons should not remove or attempt to adjust a pump, injector, nozzle or any part of the fuel injection system.
Failure to follow these instructions can result in serious injury.
6. Keep open flame away from battery or cold weather starting aids to prevent fire or explosions.
7. Do not modify or alter or permit anyone else to modify or alter this tractor or any of its components or any tractor functions.

<OPERATING THE TRACTOR>

1. Before starting the tractor apply the parking brake, place the PTO (Power Take Off) lever in the “OFF” position, the position control levers in the downward position, the hydraulic control levers in the neutral position (If fitted) and the transmission in neutral.
2. Do not start the engine or controls while standing beside the tractor. Always sit on the tractor seat when the engine or operating controls.
3. Safety start:
In order to prevent the accidental starting of the tractor, a safety switch has been provided. The starting system of the tractor is connected through this switch. On some models shuttle shifter lever and PTO button should also be in neutral position for completing the starting circuit. Do not bypass the safety switch. Consult your TYM tractor

distributor / dealer if safety switch malfunctions.

4. Avoid accidental contact with the gear shifter lever while the engine is running.
Unexpected tractor movement can result from such contact.
5. Do not get off or climb the tractor while it is in motion.
6. Shut off the engine, remove the key and apply the parking brake before getting off the tractor.
7. Do not operate the tractor in an enclosed building without adequate ventilation.
Exhaust fumes can cause death.
8. Do not park the tractor on a steep slope.
9. If power steering or Engine seizes to operate, stop the tractor immediately.
10. Pull only from the swinging draw bar or the lower link drawbar in the down position. Use only a drawbar pin that locks in place.

Pulling from the tractor rear axle carriers or any point above the rear axle may cause the tractor's front end to lift.

11. If the front end of the tractor tends to rise when heavy implements are attached to the three point linkage, install front end or front wheel weights.
Do not operate the tractor with a light front end.
12. Always use hydraulic position control lever when attaching equipment / implement and when transporting equipment.
Be sure that the hydraulic couplers are properly mounted and will disconnect safely in case of accidental detachment of implement.
13. Do not leave equipment/implement in the raised position.
14. Use the flasher / turn signal lights and Slow Moving Vehicle (SMV) signs when driving on public roads

during both day and night time, unless prohibited by law.

15. Dim tractor lights when meeting a vehicle at night.
Be sure the lights are adjusted to prevent the blinding on the eyes of coming vehicle operator.
16. Emergency stopping instruction; If tractor fails to stop even after application of brakes.
Pull the knob of fuel shut off control rod.

<DRIVING THE TRACTOR>

1. Watch where you are going especially at row ends, on roads, around trees and low hanging obstacles.
2. To avoid upsets, drive the tractor with care and at speeds compatible with safety, especially when operating over rough ground, crossing ditches or slopes, and when turning at corners.

3. Lock the tractor brake pedals together when transporting on roads to provide proper wheel braking.
4. Keep the tractor in the same gear when going downhill as used when going uphill.
Do not coast or free wheel down hills.
5. Any towed vehicle and/or trailer whose total weight exceeds that of the towing tractor, must be equipped with its own brakes for safe operation.
6. When the tractor is stuck or tires are frozen to the ground, back out to prevent upset.
7. Always check overhead clearance, especially when transporting the tractor.

<OPERATING THE PTO>

1. When operating PTO driven equipment, shut off the engine and wait until the PTO stops before getting off the tractor and disconnecting the equipment.
2. Do not wear loose clothing when operating the power take-off or near rotating equipment.
3. When operating stationery PTO driven equipment, always apply the tractor parking brake and block the rear wheels from front and rear side.
4. To avoid injury, always move down flip part of PTO.
Do not clean, adjust or service PTO driven equipment when the tractor engine is running.
5. Make sure the PTO master shield is installed at all times and always replace the PTO shield cap when the PTO is not in use.

<DIESEL FUEL>

1. Keep the equipment clean and properly maintained.
2. Under no circumstances should gasoline, alcohol or blended fuels be added to diesel fire or explosive hazard.
Such blends are more explosive than pure gasoline. In a closed container, such as a fuel tank. **DO NOT USE THESE BLENDS.**
3. Never remove the fuel cap or refuel the tractor with the engine running.
4. Do not smoke while refueling or when standing near fuel.
5. Maintain control of the fuel filler pipe when filling the tank.
6. Do not fill the fuel tank to capacity. Allow room for expansion.
7. Wipe up spilled fuel immediately.
8. Always tighten the fuel cap securely.
9. If the original fuel tank cap is lost, replace it with genuine cap. A none approved cap may not be safe.

10. Do not drive equipment near open fire.
11. Never use fuel for cleaning purpose.
12. Arrange fuel purchases so that winter grade fuel are not held over and used in the spring.
13. Use ultra-low sulfur fuel only.

⊕ IMPORTANT

- It is suggested that after repairs if any of the safety decals or signs are peeled or defaced, the same may be replaced immediately in interest of your safety.

SAFETY PRECAUTIONS

3. DOs & DON'Ts

► DOs – FOR BETTER PERFORMANCE

- DO** - Ensure that safety shields are in place and in good condition.
- DO** - Read all operating instructions before commencing to operate tractor.
- DO** - Carry out all maintenance tasks without fail.
- DO** - Keep the air cleaner clean.
- DO** - Ensure that the correct grade of lubricating oils is used and that they are replenished and changed at the recommended intervals.
- DO** - Fit new sealing rings when the filter elements are changed.
- DO** - Watch the oil pressure gauge or warning light and investigate any abnormality immediately.
- DO** - Keep the radiator filled with clean water and in cold weather use anti-freeze mixture. Drain the system only in an emergency and fill before starting the engine.
- DO** - Ensure that the transmission is in neutral before starting the engine.
- DO** - Keep all fuel in clean storage and use a filter when filling the tank.
- DO** - Attend to minor adjustments and repairs as soon as necessity is apparent.
- DO** - Allow the engine to cool before removing the radiator filler cap and adding water, remove the radiator cap slowly.
- DO** - Shift into low gear when driving down steep hills.
- DO** - Latch the brake pedals together when driving on a highway.
- DO** - Keep draft control lever fully down when not in use.

► DON'Ts – FOR SAFE OPERATION

DON'T - Run the engine with the air cleaner disconnected.

DON'T - Start the tractor in an enclosed building unless the doors and windows are open for proper ventilation.

DON'T - Operate the tractor or engine while lubricating or cleaning.

DON'T - Allow the tractor to run out of diesel fuel otherwise it will be necessary to vent the system.

DON'T - Temper the fuel injection pump, if seal is broken the warranty becomes void.

DON'T - Allow the engine to run idle for a long period.

DON'T - Run the engine if it is not firing on all cylinders.

DON'T - Ride the brake.

This will result in excessive wear of the brake lining.

DON'T - Use the independent brakes for making turns on the highway or at high speeds.

DON'T - Refuel the tractor with the engine running.

DON'T - Mount or dismount from the right side of the tractor.

DON'T - Temper the hydraulic control levers' upper limit stops.

DON'T - Use draft control lever for lifting of implements.

DON'T - Start the engine with the PTO engaged.

DON'T - Use the throttle lever while driving on roads.

DON'T - Move the hydraulic levers rearward.

4. SAFETY DECALS

► GENERAL INFORMATION OF DECALS

- In order to work with the machine safely, safety decals should be placed on the machine.
- Make sure to read and follow the following directions.

■ **KEEP THE WARNING LABELS CLEAN AND NOT DAMAGED AT ALL TIMES.**

If a decal on the machine is dirty, wash it with soapy water and wipe it off with a soft cloth. Never use solution such as thinner or acetone because these can erase characters or pictures.

■ **IF WASHED WITH HIGH PRESSURED WATER, A DECAL MAY BE PEELED OFF.**

Do not apply high pressured water directly onto decals.

■ **IF A SAFETY DECAL IS DAMAGED OR LOST, ORDER A NEW ONE IMMEDIATELY AND PLACE IT ON THE MACHINE.**

When putting a new decal, wipe off the place to post the decal thoroughly and wait till it is dried. Then post the decal.
Each decal has a part number on the bottom.

■ **WHEN REPLACING A PART ATTACHED WITH A DECAL WITH A NEW PART, REPLACE THE DECAL AS WELL.**

► SAFETY DECALS ON CHASSIS

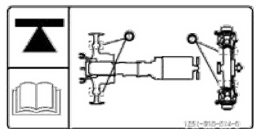
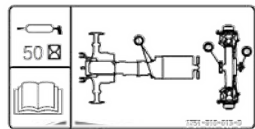
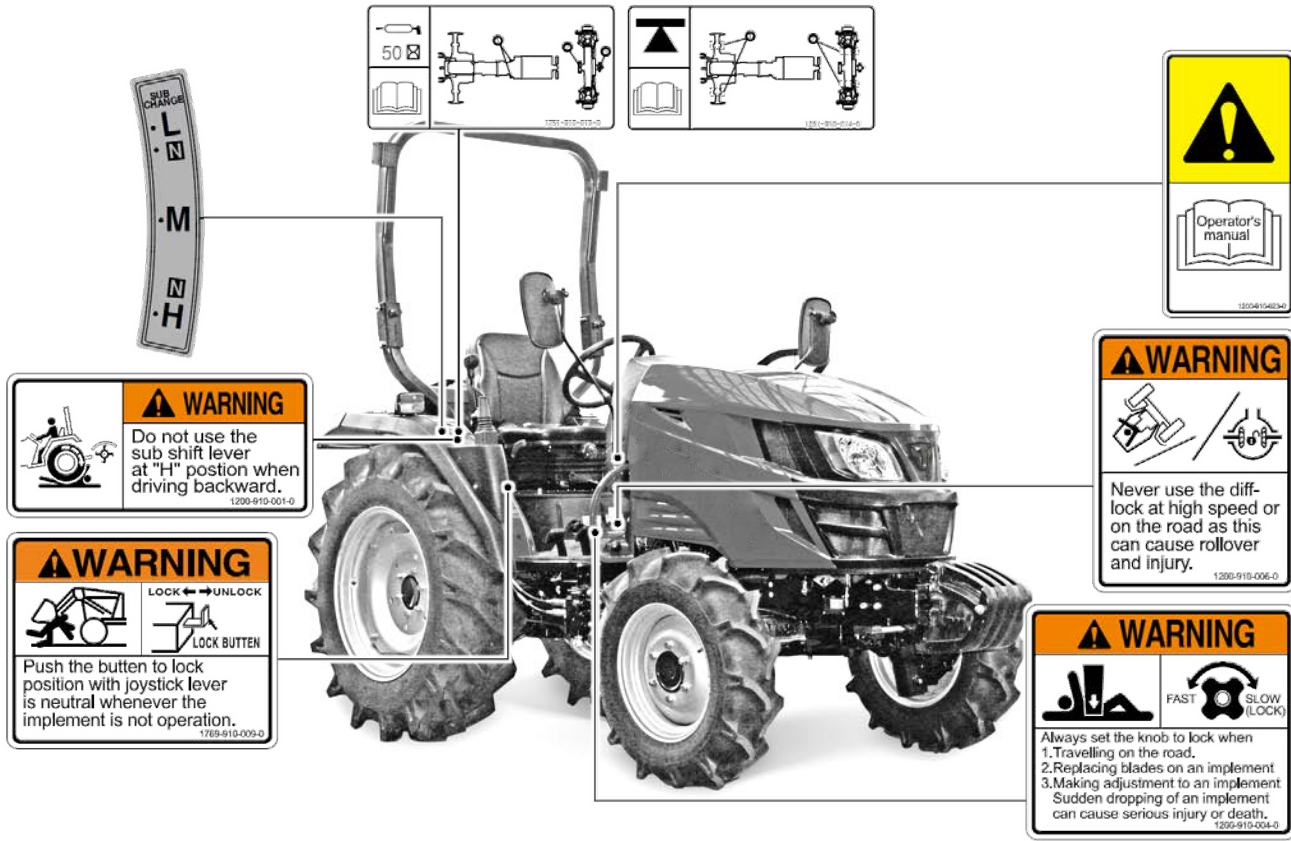

Operator's manual

1820-910-042-0

WARNING

Do not use the sub shift lever at "H" position when driving backward.

1200-910-001-0

WARNING

Never use the diff-lock at high speed or on the road as this can cause rollover and injury.

1200-910-006-0

WARNING

LOCK → UNLOCK
LOCK BUTTEN

Push the button to lock position with joystick lever is neutral whenever the implement is not operation.

1769-910-009-0

WARNING

FAST SLOW (LOCK)

Always set the knob to lock when

1. Travelling on the road.
2. Replacing blades on an implement
3. Making adjustment to an implement

Sudden dropping of an implement can cause serious injury or death.

1259-910-004-0

! SAFETY PRECAUTIONS

! WARNING



Do not remove radiator cap while engine is hot. Hot steam will injure you.

1200-910-015-0

! WARNING

- Start engine only from operators seat. If safety start switch is bypassed engine can start with transmission in gear.
- Do not connect or short across terminal on starter solenoid.
- Attach booster cables as shown on battery decal and operators manual.

Starting in gear causing runaway can result in serious injury.

! CAUTION



Do not touch while the system is hot. It cause serious burns

1200-910-024-0



! DANGER



Rotating driveline contact can cause death. KEEP AWAY! Keep all drive line. Tractor and equipment shields in place during operation.

1200-910-013-0

! WARNING



Attach implements and trailers to the tractor only using the prescribed drawbar or hitch.

1200-910-014-0

! DANGER



Do not ride except operator.



1200-910-016-0

! WARNING



Work in ventilated Area.

1200-910-003-0

ON



↓



OFF

1788-920-005-0

WARNING



Do not use the sub shift lever at "H" position when driving backward.

1200-910-001-0

WARNING



LOCK → UNLOCK
LOCK BUTTEN

Push the button to lock position with joystick lever is neutral whenever the implement is not operation.

1789-910-009-0

WARNING



Stay clear of raised Boom and bucket.



WARNING



Always fasten Your seat belt.

1200-910-019-0



1200-910-006-0

WARNING



Never use the diff-lock at high speed or on the road as this can cause rollover and injury.

1200-910-006-0

SAFETY PRECAUTIONS

WARNING



Do not remove radiator cap while engine is hot. Hot steam will injure you.



1200-910-019-0

Inner/Outer air Ventilation

- When grills of rear and both sides are opened, inner air will ventilate in.
- For effective use, open it when operate heater or air conditioner and close when ventilate fresh air.

1220-904-122-1

DANGER



Periodic ventilation should be made to avoid suffocation while heating an air conditioning is used. Sleeping in the cab is prohibited.

WARNING



Work in ventilated Area.

1200-910-003-0

CAUTION



Keep hands and clothing away from rotating fan and belts to prevent serious injury.

1200-910-012-0



DANGER



Do not ride except operator.



5300-910-016-0

WARNING

- Start engine only from operators seat, if safety start switch is by passed engine can start with transmission in gear.
- Do not connect or short across terminal on starter solenoid.
- Attach booster cables as shown on battery decal and operators manual.

Starting in gear causing runaway can result in serious injury.

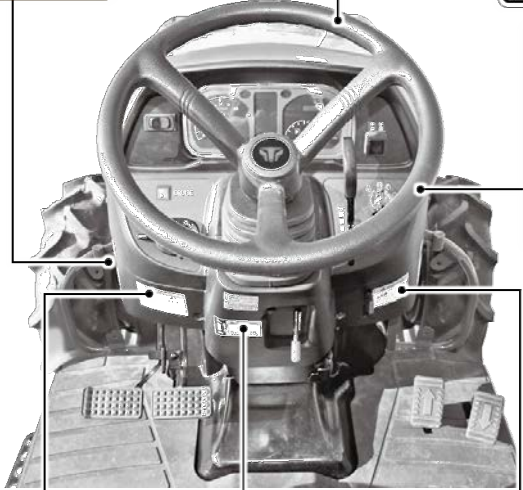

WARNING



Do not use the accelerator lever except working on the field.

1200-910-0214-C

!

Operator's manual

1200-910-0214-C

WARNING



Brake pedals must always be locked together when traveling on the highway. This will ensure uniform braking and provide maximum stopping ability sharp turns must only be made at slow speeds.

1200-910-0212-C

WARNING



Do not adjust the tilt handle when traveling.

1200-910-0210-B

WARNING



Always apply the park brake when parking. Failure to do so can cause accidents and damages.

1200-910-0202-C

WARNING



Do not refuel the tractor while smoking or near naked flame or sparks, always stop engine before refueling tractors.

1200-910-0205-C

WARNING



Attach implements and trailers to the tractor only using the prescribed draw-bar or hitch.

1200-910-014-C



DANGER



Rotating driveline contact can cause death. KEEP AWAY! Keep all drive line. Tractor and equipment shields in place during operation.































1200-910-0203-B

B

SAFETY PRECAUTIONS

5. UNIVERSAL SYMBOLS

Some of the universal symbols have been shown below with an indication of their meaning.

DESCRIPTION	SYMBOL	DESCRIPTION	SYMBOL	DESCRIPTION	SYMBOL
ENGINE SPEED (REV/MIN X 100)		PRESSURED, OPEN SLOWLY		CORROSIVE SUBSTANCE	
HOURS, RECORDED		CONTINUOUS VARIABLE		SLOW OR MINIMUM SETTING	
ENGINE COOLANT TEMPERATURE		HAZARD WARNING, CAUTION		FAST OR MAXIMUM SETTING	
FUEL LEVEL		HAZARD WARNING		TRANSMISSION OIL PRESSURE	
ENGINE STOP CONTROL		NEUTRAL		TURN SIGNAL	
LIGHTS		FAN		TRANSMISSION OIL TEMPERATURE	
HORN		POWER TAKE OFF ENGAGED		PARKING BRAKE	
ENGINE OIL PRESSURE		POWER TAKE OFF DISENGAGED		WORKING LAMP	
AIR FILTER CONTAMINATED		RAISE LIFT ARM		DIFFERENTIAL LOCK	
BATTERY CHARGE		LOWER LIFT ARM		REFER TO OPERATOR'S MANUAL	



C. TRACTOR INSTRUMENTS

1. SWITCHES C – 2
2. MONITOR PANEL & GAUGES C – 7
3. CONTROL INSTRUMENTS C – 13
4. THREE POINT LINKAGE C – 24
5. CABIN C – 29

1. SWITCHES

► FIGURE OF SWITCHES (ROPS)

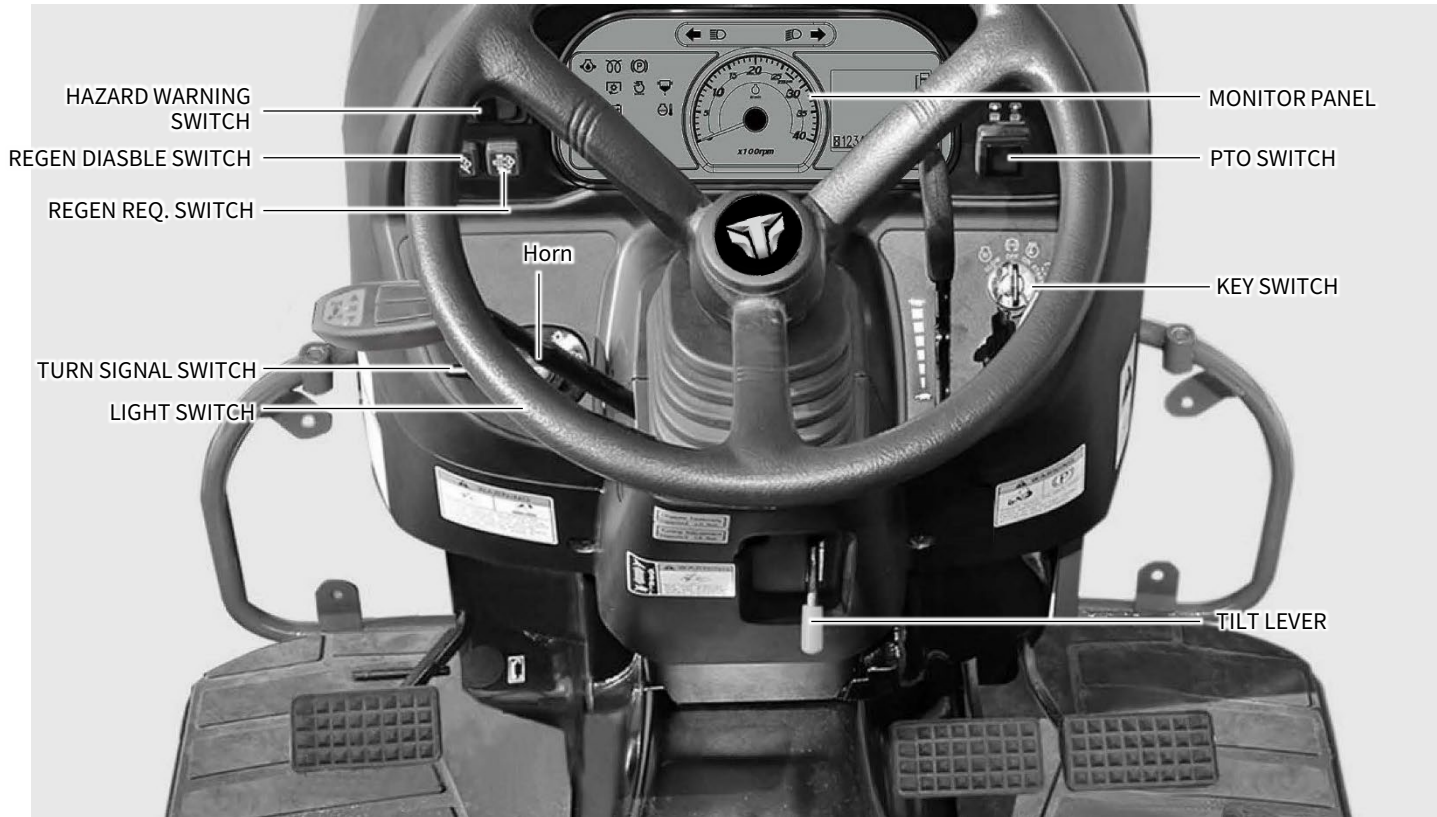

► FIGURE OF SWITCHES (CABIN)

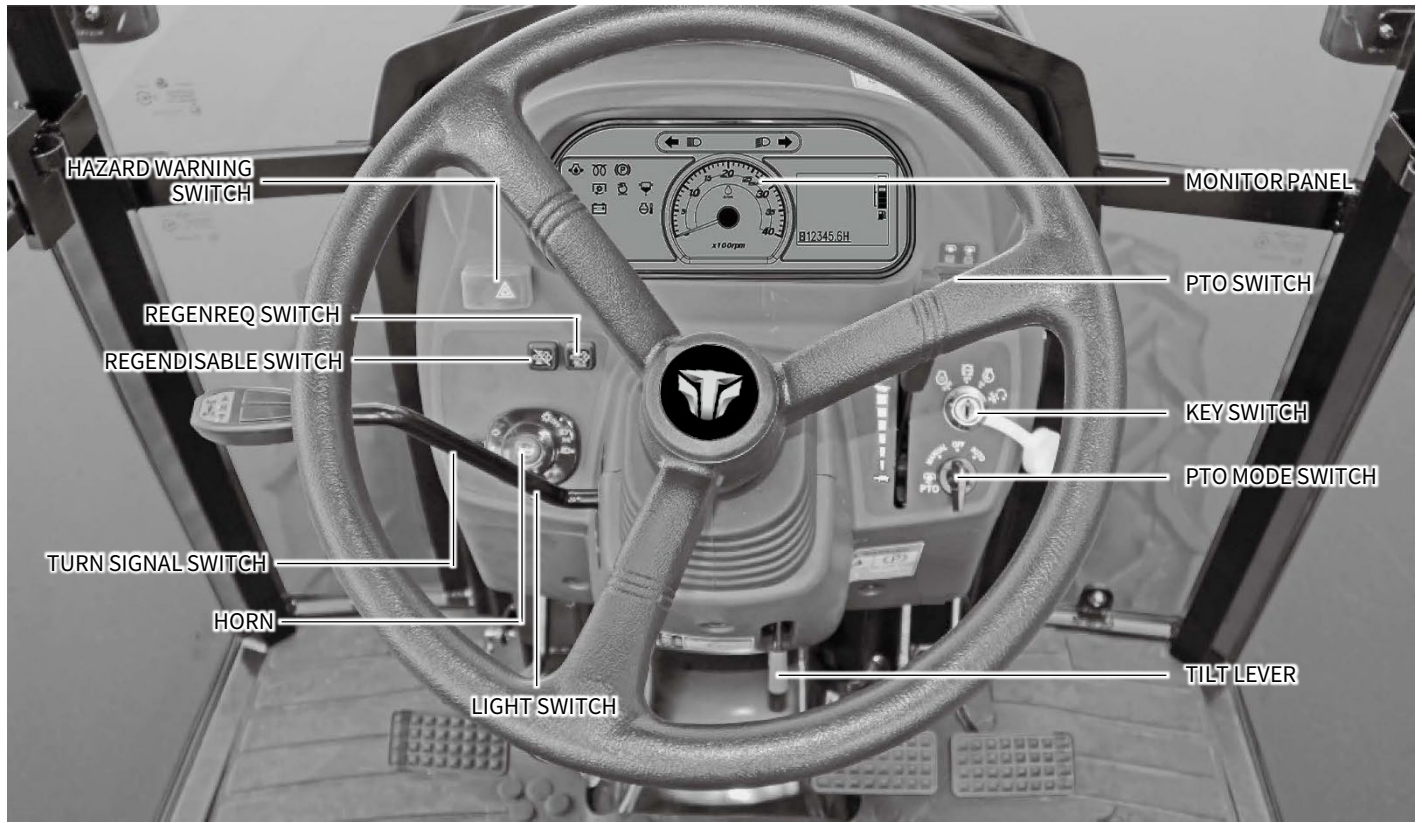

▶ KEY SWITCH



It is used to start and stop the engine.

- "OFF" position
The ignition key can be inserted and removed in this position.
When turning the switch to OFF position with the engine running, the engine is stopped.
- "ON" position
The engine is kept running and the switch is energized in this position.
- "START" position
The engine can be started in this position. When releasing the key, the switch is returned to ON position.
- "GLOW" position
The engine's combustion chamber is pre-heated in this position.

▶ COMBINATION SWITCH

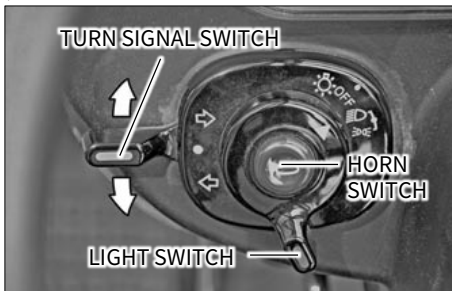

<Light switch operation>

The light switch can be operated with the key switch in the "ON" position.

- 「OFF」 - All light OFF
- ☹️ - Instrument lamp, tail lamp and low beam lamp ON.
- ☹️☹️ - Instrument lamp, tail lamp and high beam lamp ON.

<Turn signal lamp operation>

The turn signal lamps can be operated with the key switch in the "ON" position.

- Left turn - Turn the turn signal switch counterclockwise.
Then, the left turn signal lamp and the left turn signal indicator on the instrument cluster blink.

- Right turn - Push the turn signal switch clockwise.
Then, the right turn signal lamp and the right turn signal indicator on the instrument cluster blink.

<Horn>

The horn can be operated with the key switch in the "ON" position regardless of the light switch.

- Operating - Press the switch sounds the horn.

⚠️ WARNING

- The high beam can obstruct the view of other drivers coming in the opposite direction on a road, leading to an unexpected accident.

🚫 IMPORTANT

- This lever is not automatically returned to the neutral position. Therefore, set it back to the neutral position after turn.

► HAZARD WARNING SWITCH

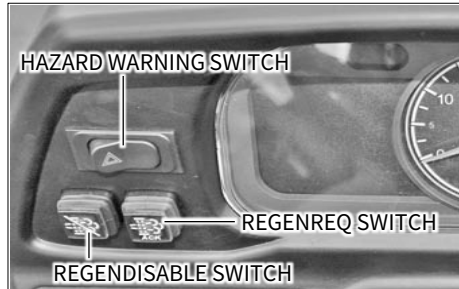

This switch can be used to warn other vehicles when malfunction occurs in the tractor while driving on a public road. When pressing the switch once, the left and right hazard warning lamps blink. Pressing the switch again turns off the lamps.

► PTO SWITCH

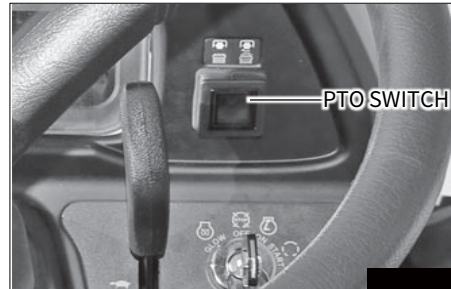

Positions of the PTO switch are as follows :

- 「ON」
When pressing the switch, the red lamp comes on and the PTO shaft rotates.
- 「OFF」
When pressing the switch again, the lamp goes off and the PTO shaft stops rotating.

► PTO MODE SWITCH

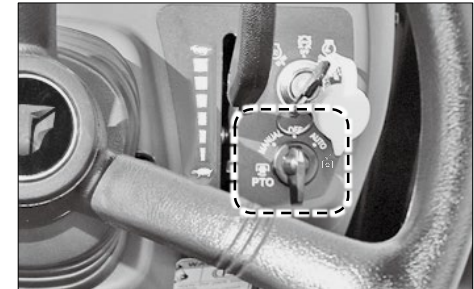

Operation of PTO mode switch are as follows :

- 「OFF」 - The PTO shaft is stopped.
- 「Automatic」 - When the implement is lifted to the preset height, the PTO shaft is automatically stopped.
- 「Manual」 - The rotating status of the PTO shaft can be controlled by operating the PTO switch to the ON/OFF position manually.
- 「INTENTION」 - If PTO switch is on, PTO shaft rotates whether operator is on the seat or not.

C

2. MONITOR PANEL & GAUGES

▶ FIGURE OF MONITOR PANEL

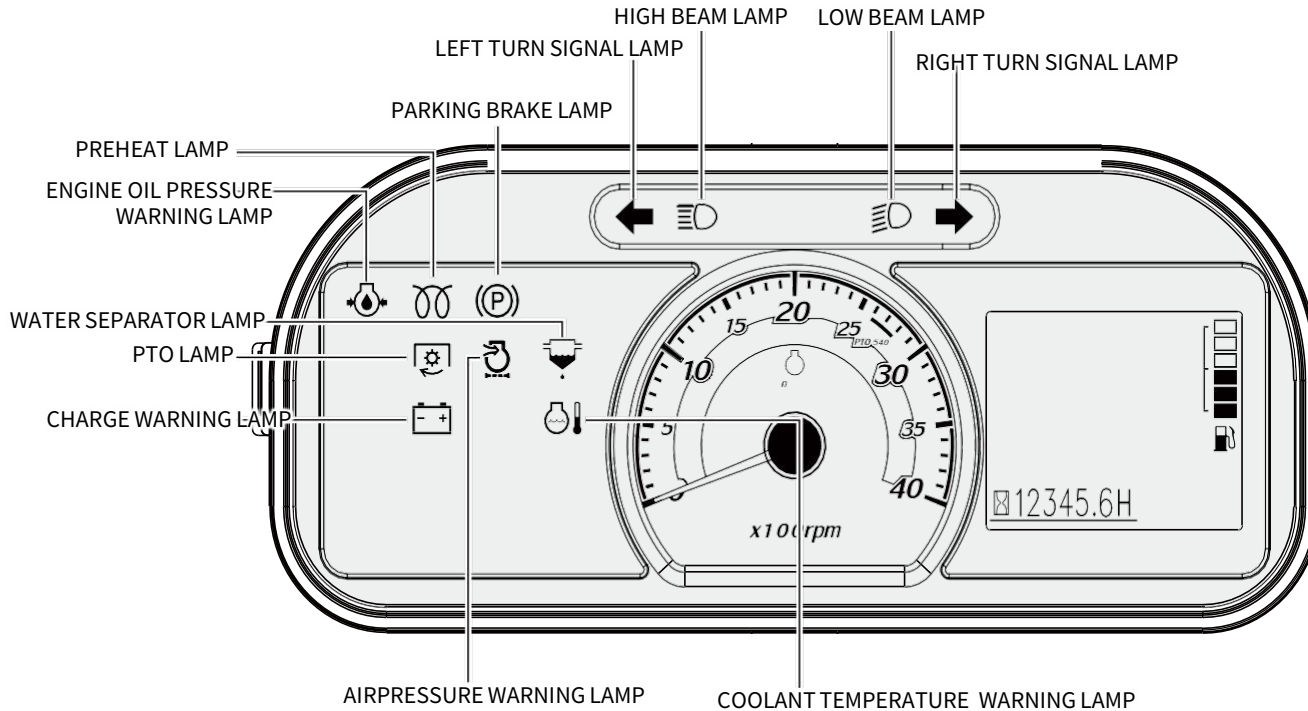

▶ TACHO METER

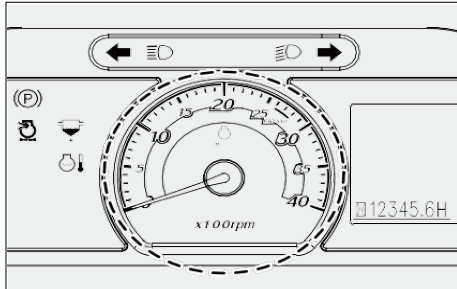

It displays the revolution of the engine or PTO shaft per minute.

▶ HOUR METER

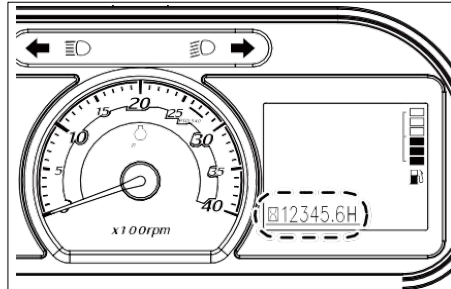

It indicates the total time of use. The last digit indicates one tenth hours. (decimal place) While the hour meter on the leftmost section is in operation, the lamp below it blinks.

▶ FUEL GAUGE

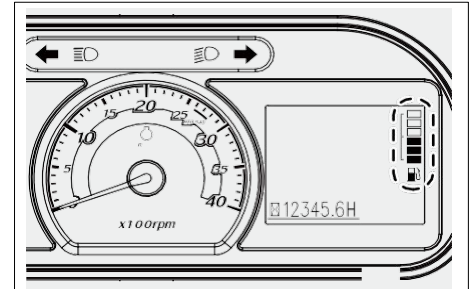

This indicates the amount of fuel while the key switch is in the ON position.

- F – Full
- E – Empty

 IMPORTANT

- Poor fuel quality can damage the engine. Make sure to use only the specified genuine diesel fuel.
- Use fuel for winter season in winter to enhance engine starting performance.

C

▶ COOLANT TEMPERATURE WARNING LAMP

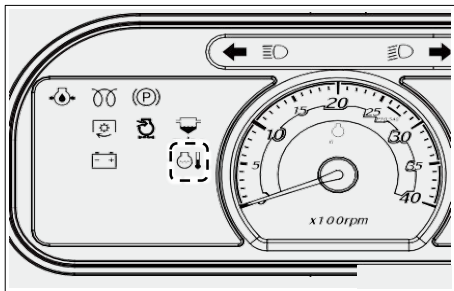

If this lamp comes on, coolant is overheated.

If the lamp is on, the coolant is overheated. In this case, stop driving and take any necessary action according to the troubleshooting instructions.

IMPORTANT

- When the coolant temperature warning lamp comes on, coolant is overheated so check the coolant.

▶ TURN SIGNAL LAMPS

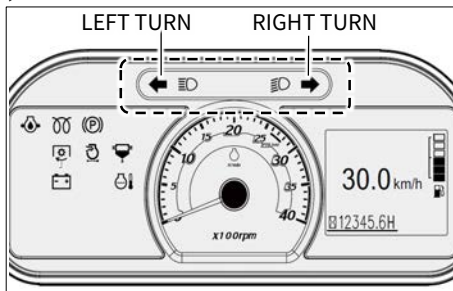

This lamp is used to indicate the intended turning direction of the driver. When pulling down the turn signal switch, the left turn signal lamp blinks. When pushing up the turn signal switch, the right turn signal lamp blinks. These lamps are operated when pressing the hazard warning lamp switch as well.

▶ HEADLIGHT LAMPS

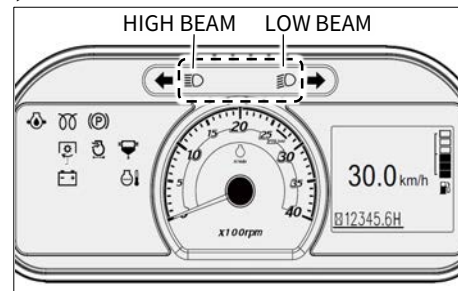

- High beam lamp
This comes on when the high beam is turned on.
- Low beam lamp
This comes on when the low beam is turned on.

▶ GLOW LAMP

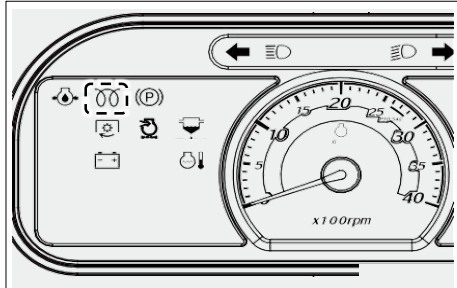

This comes on while the engine preheating function is activated. It goes off as soon as preheating is completed.

▶ PARKING BRAKE LAMP

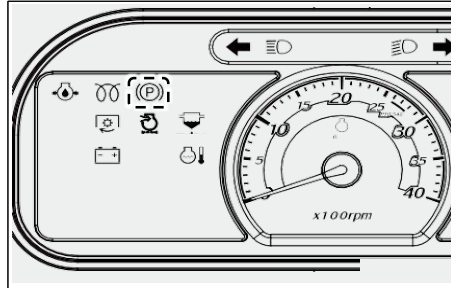

This comes on when the parking brake is applied.

▶ FUEL WARNING LAMP

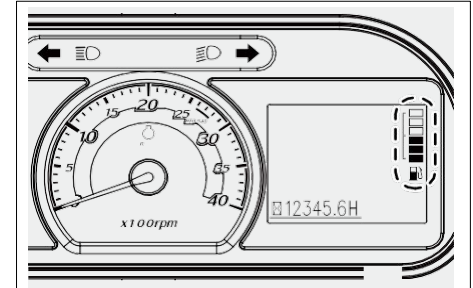

If keeping driving with the needle of the fuel gauge pointing at 'E,' the warning lamp comes on which means there is only approx. 5 liters of fuel left in the tank.

C

▶ **CHARGE WARNING LAMP**

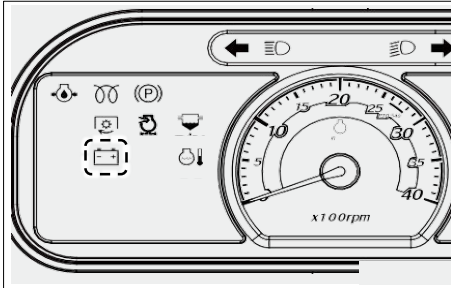

This comes on when the key switch is turned to the ON position, and goes off as soon as the engine is started.

+ **IMPORTANT**

- If the charge warning lamp comes on while driving, the battery is not properly charged. Therefore, turn off any unnecessary electrical devices and have your vehicle checked by your workshop immediately.

▶ **ENGINE OIL PRESSURE WARNING LAMP**

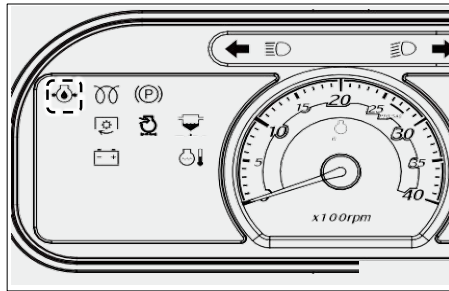

This is illuminated when the engine oil pressure or oil amount is insufficient during driving.

+ **IMPORTANT**

- When the oil pressure warning lamp comes on, this indicates malfunction of the lubrication system. Check the engine oil immediately and have your vehicle serviced by your workshop as necessary.

▶ **PTO LAMP**

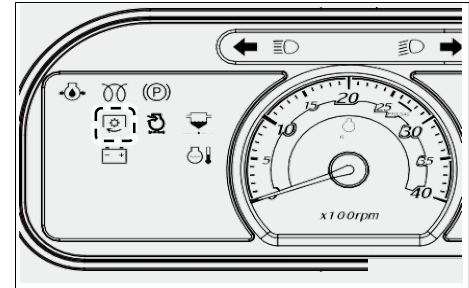

This indicates the state of PTO rotating.

- ON – The PTO shaft is rotating
- OFF – The PTO shaft is stopped.
- BLINK – The PTO shaft is stopped, but will start to rotate when a implement is lowered.

▶ **WATER SEPARATOR WARNING LAMP**

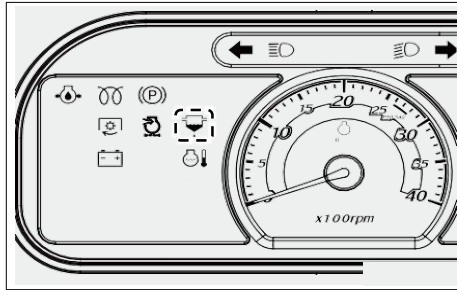

When a certain amount of water is collected in the filter of the oil-water separator, this lamp comes on.

IMPORTANT

- If the oil-water separator warning lamp comes on, drain water from the fuel filter as soon as possible.

▶ **AIR CLEANER FILTER CONTAMINATION LAMP**

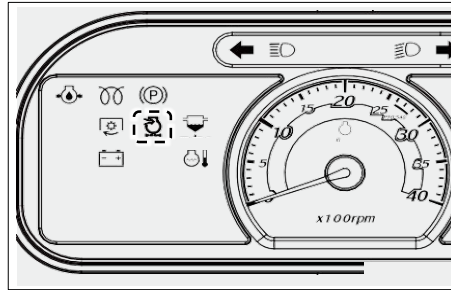

This comes on when the air cleaner is clogged by foreign materials. When this comes on, open the cover and clean the inside of the cleaner. Also, blow air through the filter in the direction of intake air to clean it or replace the filter with a new one.

IMPORTANT

- If keeping driving with this warning lamp illuminated, the engine power can be dropped.

▶ **DPF PROGRESS LAMP**

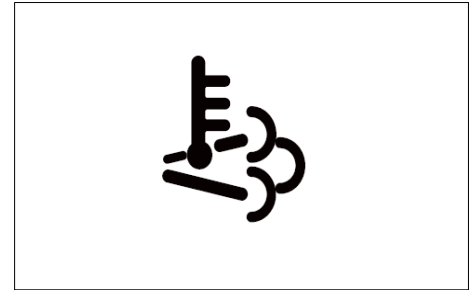

This lamp comes on when DPF regeneration is in progress.

IMPORTANT

- Do not perform other work during regeneration.

▶ **DPF WARNING LAMP**

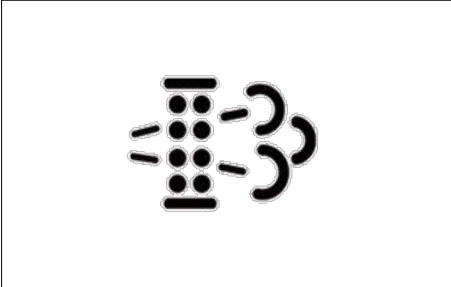

This lamp blinks when carbon is accumulated in the diesel particulate filter.

If this lamp blinks, press the regeneration button.

▶ **ENGINE WARNING LAMP**

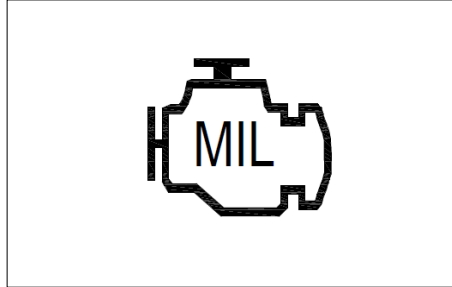

This lamp comes on when the engine is malfunctioning.

▶ **NCD LAMP**



This lamp comes on with MIL lamp when either EGR sensor or air temperature sensor doesn't function properly.

 **WARNING**

- Contact your dealer to repair immediately when engine warning lamp or NCD lamp com on.

3. CONTROL INSTRUMENTS

► FIGURE OF TRACTOR CONTROLS

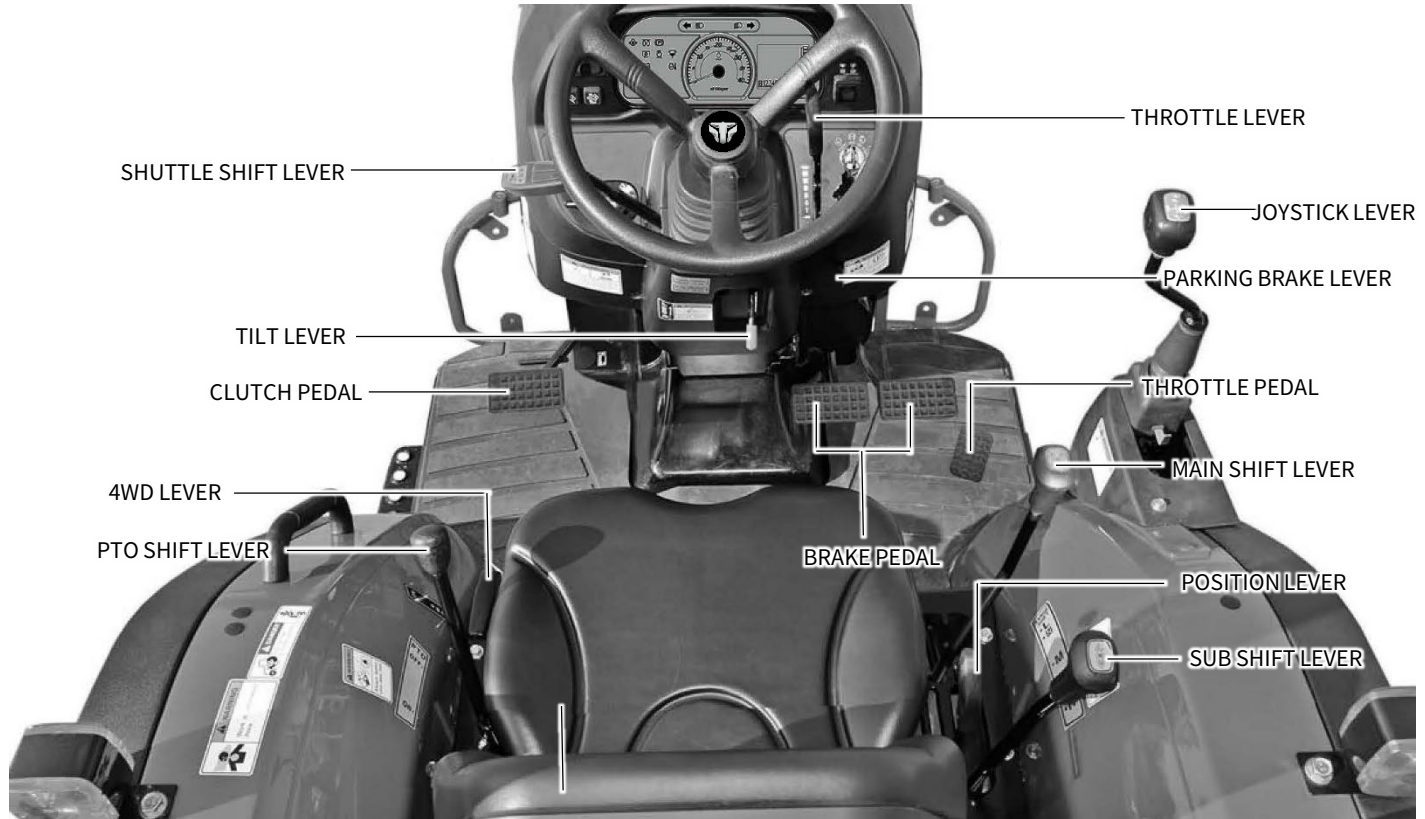

▶ BRAKE PEDALS

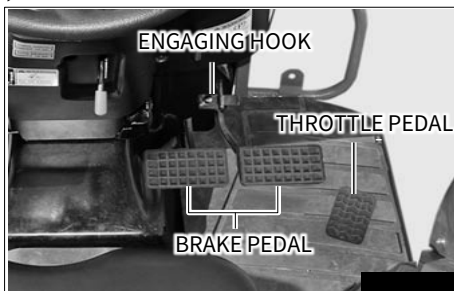

The brake is used to stop the vehicle forcibly.

This vehicle is equipped with separate brakes for its left and right sides. Therefore, it is possible to apply braking force only to one rear wheel. When the one side brake lever is released, the warning lamp is illuminated.

When the lever is engaged, the lamp is turned off.

There is an engaging hook for connecting the left and right brake pedals.

- **Driving on road** – Engage (both brake pedals operated together)
One-side brake warning lamp OFF
- **Working in field** – Disengage (One side brake pedal operated)
One-side brake warning lamp ON

⚠ WARNING

- Connect the left and right brake pedals while driving on a road, loading/unloading the vehicle or driving into/out of a field to avoid rollover and collision.
- Check the left and right brakes periodically so that they can be operated simultaneously.

▶ PARKING BRAKE LEVER



1. Lift brake handle up to set the park brake.
2. Lift parking brake handle slightly until parking brake release button can be depressed. Hold button in and lower parking brake handle all the way down to release the parking brake.

⊕ IMPORTANT

- The tractor does not move with buzzer sound when operating the shuttle shift lever with the parking brake applied. In this case, release the parking brake with the shuttle shift lever in the neutral position.

▶ **THROTTLE LEVER**

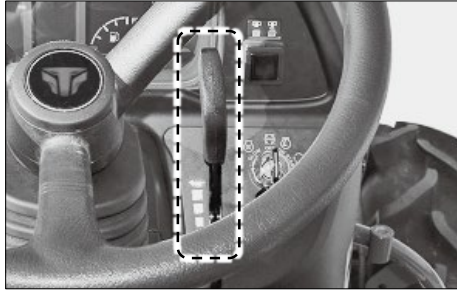

It is used to adjust the engine speed like the throttle pedal.



Pushing : increasing speed



Pulling : decreasing speed



WARNING

- Never use it unless working in a field. It can lead to speeding and an accident.

▶ **CLUTCH PEDAL**

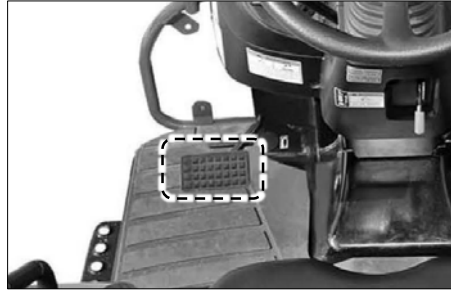

Depressing the clutch pedal disengages the clutch.

With the clutch pedal depressed, move the main, sub or shuttle shift lever into the desired position and release the pedal.

Then, the clutch is engaged.

▶ **SHUTTLE SHIFT LEVER**

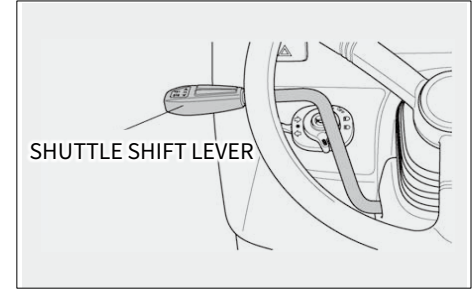

This control allows shifting from forward to reverse & reverse to forward. When stationary set the lever to "N" for neutral.

Push the lever away from the driver engages forward.

Pulling the lever towards the driver engages reverse.



IMPORTANT

- Press clutch pedal fully before operating shuttle shift lever.

IMPORTANT

- When changing from forward to reverse or back to forward again while in high range make sure the tractor comes to a stop before changing direction. Failure to do so is likely to result in damage to the mechanism and place the driver at risk of injury.

CAUTION

- Operate the shuttle shift only while seated on the tractor.
- Do not use the shuttle shift lever to start the tractor for towing or traveling uphill, use the clutch instead.
- Always stop the tractor before getting off.

▶ **MAIN GEAR LEVER**



This lever can be shifted by using the clutch, both when the tractor is stationary or mobile. It is located on the R.H.S of the driver seat.

▶ **SUB SHIFT LEVER**



The driving direction can be selected between forward direction and reverse direction using the shuttle shift lever and range shift lever. Use the throttle lever to increase / decrease the engine speed.

WARNING

- When the range shift lever is placed in the position "H," the driving speed increased. Therefore, never put the range shift lever in the position "H" during driving backwards.

IMPORTANT

- Operate the range shift lever only after the tractor is completely stopped. Shifting the lever during driving can damage the gears.

▶ **TILT LEVER**



Adjust the inclination of the steering wheel to set it to the desired position.

▶ **DIFFERENTIAL LOCK PEDAL**



The differential lock is a device to lock the differential system in order to rotate the left and right wheels at the same speed.

This function can be used when the rear wheels slip or one wheel spins.



Engagement - Depressing pedal



Disengagement - Releasing pedal

C



<Examples of useful conditions of differential lock>

1. One wheel slips or tractor cannot be driven forward when moving into/out of a field.
2. A wheel slips during work requiring traction, such as plowing.
3. One wheel is stuck into a soft field and can't escape.

⚠ WARNING

- Never use the differential lock when driving on a road. A collision or rollover can occur.
- Make sure to release it during turning. Otherwise, it can lead to an injury or accident.

🛠 IMPORTANT

- When using the differential lock, run the engine at a low speed.
- If differential lock is still not disengaged after releasing the differential lock pedal, gently depress the left and right brake pedals alternately.

▶ 4WD LEVER



- 「ON」
Pull the shift lever to the "ON" position to engage 4WD.
- 「OFF」
Push the shift lever to the "OFF" position to disengage 4WD.

<Examples of useful conditions of 4WD>

The 4WD can be used under the following conditions

1. When cultivating in a field.
2. When traction is required on a slope, in a wet field or for towing a trailer.
3. When working in a wet or sandy field.

4. When cultivating on firm soil with a rotavator to prevent the tractor from being pushed forward.
5. When driving into/out of a field or going over a field bank.

🛠 IMPORTANT

- Before operating the 4WD lever, make sure to stop the tractor.
- If it is hard to engage the 4WD lever, do not apply excessive force to it. Instead, drive the tractor forward or backward slightly and try it again.
- Avoid using 4WD on public roads to reduce wear on tires.

► **HYDRAULIC LOWERING SPEED CONTROL KNOB**

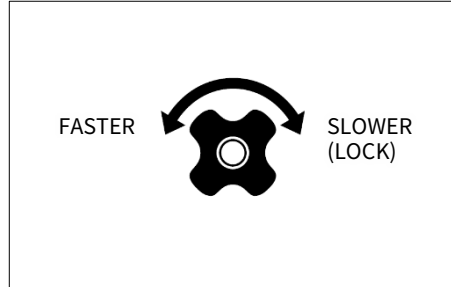

This can be used to adjust the lowering speed of the implement.

Adjust the lowering speed according to the implement type and working environment.

<Operation>

Rotavator - Slow the lowering speed.

Plow - Speed up the lowering speed.

- Decreasing lowering speed:
Turn the knob clockwise (slower).
- Increasing lowering speed:
Turn the knob counterclockwise (faster).
- Lock:
Turn the knob clockwise (slower) to its end.

⚠ WARNING

- Set it to the Lock position under the following conditions to prevent falling of the implement :
 - ✓ When driving on a public road
 - ✓ When replacing the rotavator blade or removing straws and grass
 - ✓ When servicing the implement

► **POSITION LEVER**

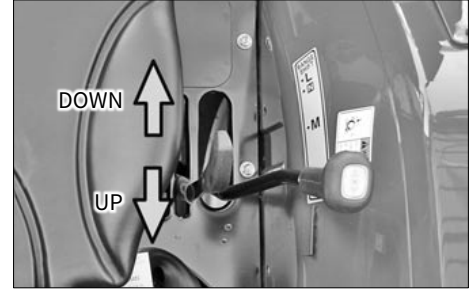

This lever is used to lift and lower an implement to a certain working height freely and maintain it.

<Operation>

- Lifting implement:
Pull the lever back to lift the implement.
- Lowering implement:
Push the lever forward to lower the implement.

⚠ WARNING

- When leaving the tractor, make sure to lower the implement and stop the engine.
Others may operate one of the controls, leading to a dangerous situation.

C

▶ **REMOTE CONTROL LEVER**

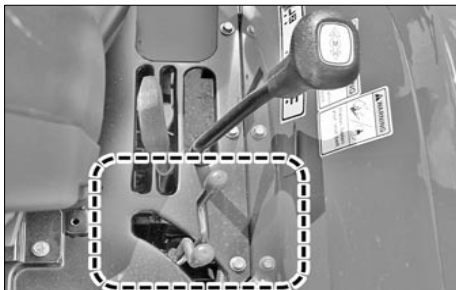

When using an attachment for an implement (rotavator, hydraulic plow, etc.), connect its hose to the proper port between the port A and B according to its use.

- Lever A operation - Hydraulic pressure applied to the port A of the external hydraulic valve coupler
- Lever B operation - Hydraulic pressure applied to the port B of the external hydraulic valve coupler

▶ **REMOTE CONTROL VALVE**

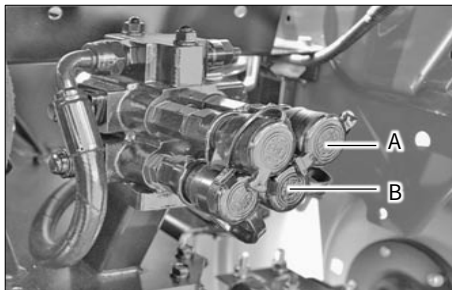

<How to engage coupler>

1. Clean the couplers on the tractor and implement thoroughly.
2. Remove the dust cover from the tractor side. Then, fit the male coupler on the implement side while moving its external ring backward slightly.
3. Pull the male coupler on the implement side backward slightly to check its firm engagement.

<How to disengage coupler>

1. Lower the implement on the ground to release pressure in the hydraulic hose.
2. Stop the engine and operate the remote hydraulic lever to remove any residual pressure in the hose.
3. Disconnect the male coupler on the implement side while moving its external ring on the tractor side backward slightly.
4. Wipe oil and dust from the coupler and plug the dust cover.

 **WARNING**

- To prevent a burn and skin damage, make sure to stop the engine before connecting or disconnecting the coupler.
- Do not use your hands to check for oil leakage.

▶ FRONT LOADER VALVE

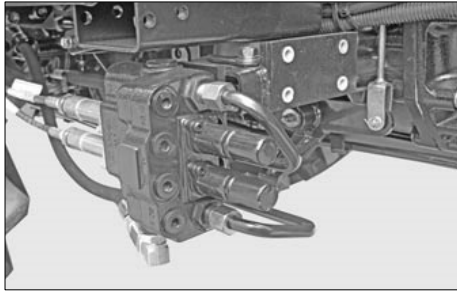

The loader valve is installed under the step on the right side and the joystick lever is installed on the right section in the cabin for easy installation and operation of a loader.



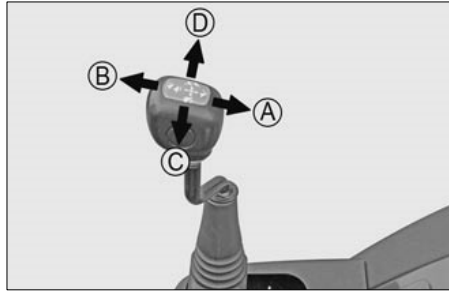

⚠ WARNING

- Abnormal operation of a loader can lead to an accident. Therefore, when connecting the hydraulic pipes, set the valve connection according to the operating directions specified on the label attached to the joystick lever.

▶ JOYSTICK LEVER



<Joystick lever operating directions>

-  - Boom down (B)
-  - Boom up (A)
-  - Bucket up (C)
-  - Bucket down (D)

⊕ IMPORTANT

- Do not operate the boom cylinder and bucket cylinder at the same time. A loader may malfunction due to insufficient oil flow.

▶ JOYSTICK LEVER SAFETY DEVICE

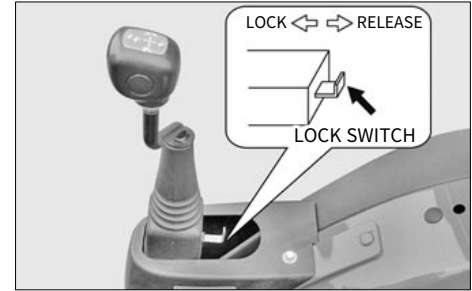

<Joystick lever safety device>

There is a switch to lock the operation of the joystick lever. Pulling it forwards unlocks the lever while pushing it backwards locks the lever.

⚠ WARNING

- Make sure to set the joystick lever in the neutral position and press the lock button to lock the lever in that position when the lever is not in use. Otherwise, an implement may fall accidentally by unintended operation of the lever.

C

▶ **PTO SHIFT LEVER**



- 「ON」
Pull the shift lever to the "ON" position to engage PTO.
- 「OFF」
Push the shift lever to the "OFF" position to disengage PTO.

PTO	RPM
PTO speed	540 rpm

IMPORTANT

- Operate the PTO shift lever only after setting the PTO ON/OFF switch to the OFF position.

▶ **MID PTO (OPTION)**

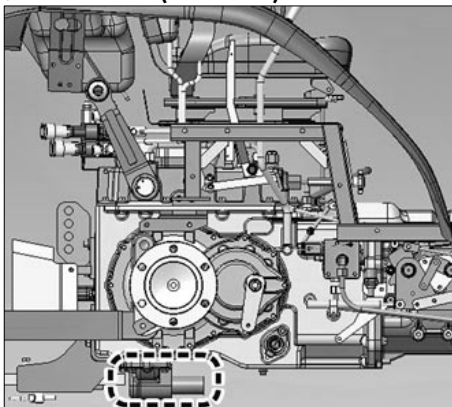

The mid PTO lever is used with the PTO shift lever and its setting speed is 2,000 rpm. Its operation is as follows according to its each shift position:

PTO	RPM
MID PTO	2,000

WARNING

- Do not operate the implement at a higher speed than the specified level.
- Before adjusting an implement, stop the engine to prevent a serious injury.

IMPORTANT

- Operate the PTO shift lever only after setting the PTO switch to the OFF position.

▶ **PTO SHAFT CAP**

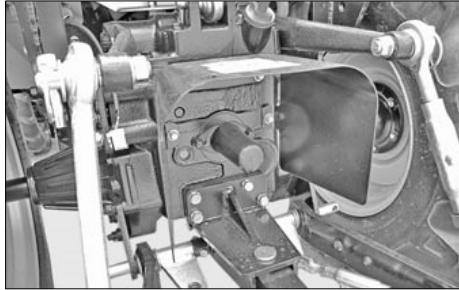

When the PTO shaft is not in use, grease the PTO shaft and install the cap to it.

 **DANGER**

- If caught by the PTO shaft, a severe injury or even death can occur.
- Stay out of the PTO shaft while it is rotating.
- When the PTO shaft is not in use, place the cap over it.
Also, never remove the PTO safety cover.

 **CAUTION**

- It is dangerous to use an implement at a high speed if it is designed to be operated at a low speed.
- Before using an implement, make sure to read its owner's manual.

▶ **SEAT AND SAFETY BELT**



<Seat sliding>

The seat can be adjusted by moving it forwards and backwards with the seat sliding lever on its front pushed to the left.

After adjustment, make sure that the seat is firmly secured.

<Seat belt>



Before driving, adjust the belt's length to fit to your body and insert it into its buckle.

When it is engaged properly, a clicking sound is heard.

4. THREE POINT LINKAGE

▶ FIGURE OF THREE POINT LINKAGE (ROPS)

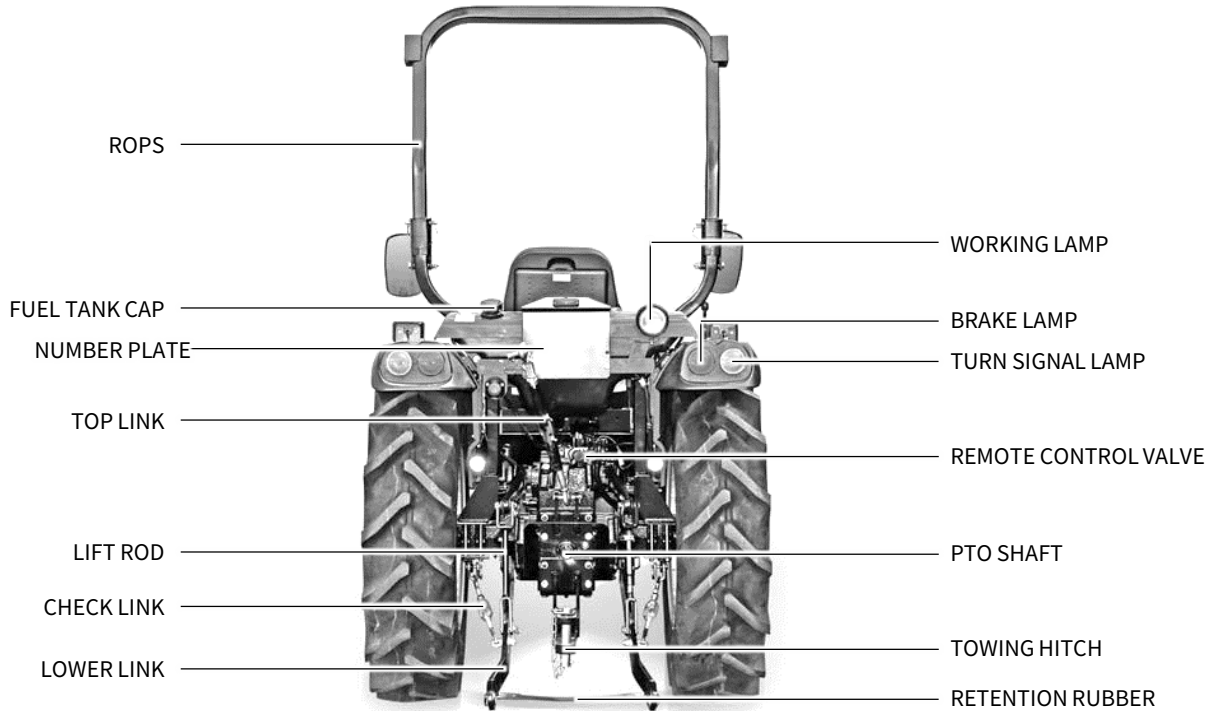

► FIGURE OF THREE POINT LINKAGE (CABIN)

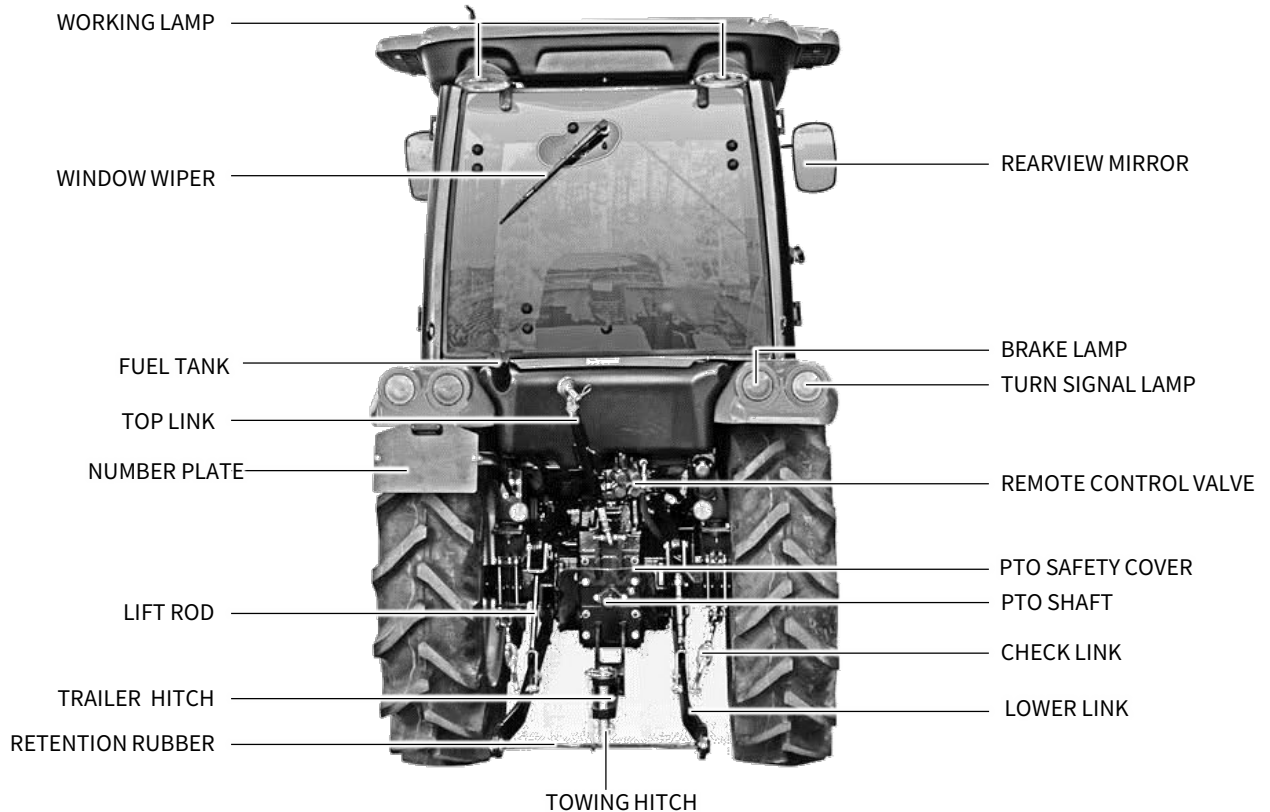

C

▶ **TOP LINK ADJUSTMENT**

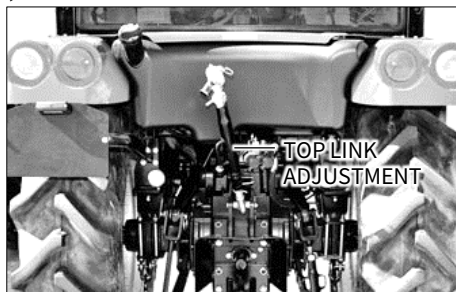

1. The angle of an implement can be adjusted by extending or retracting the top link.
2. After adjustment, fix the adjusting lever with its mounting nut.

▶ **CHECK LINK**

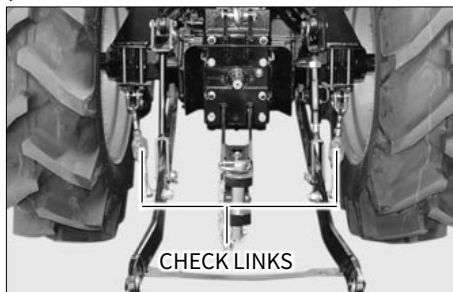

The check link can be adjusted to relieve vibration and shock of an implement.

▶ **LOWER LINK**

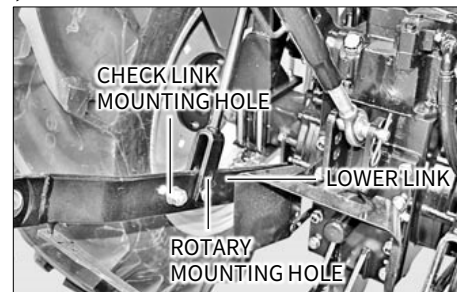

An implement can be attached to this. The installation type is Category I.

+ **IMPORTANT**

- When no implement is attached, fix the lower links with the left and right check links so that they do not touch the rear wheels.
- Engage the top link with the hook.

► TOWING DEVICES

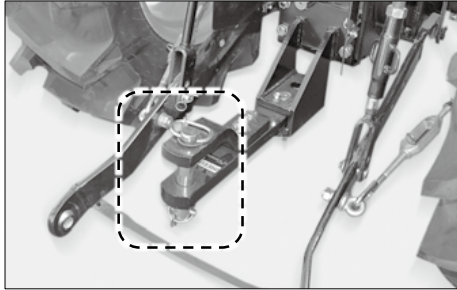

 **DANGER**

- Only use trailer hitch to tow and keep the 3 point linkage in raised position when towing with the drawbar.
- Position can create unbalance causing the Tractor to roll-over & Result the death or serious injury.

 **WARNING**

- All the implements mounted on the tractor must be secured firmly and in accordance with the manufacturer's instructions; see attachment holes diagram. Use permitted devices only.

 **WARNING**

- The front towing hitch should be used for emergency trailer towing or for towing the tractor in the yard or in an authorized service centre.
- When towing, always secure the hitch pin with a suitable lock pin with safety clip to prevent the hitch pin coming out the hitch.
The lock pin must always be secured to the hitch.
- The maximum permissible hitch load (horizontal and vertical), the maximum Permissible hitch height for road. Use and the maximum trailed load are indicated in the tractor registration document.

 **CAUTION**

- Never tow semi-mounted implements, trailers or agricultural machines by attaching them to the top link of the three-point linkage.
This could cause the tractor to rear up or overturn backwards.
- Do not allow anyone to ride on the drawbar or the lower links when the tractor is in motion.

► IMPLEMENT HITCHING AND UNHITCHING

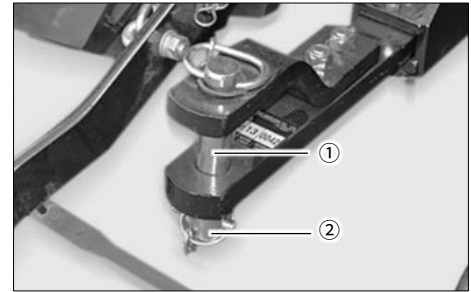

To hitch an implement to the drawbar, proceed as follows

- Remove lock pin ①
- Remove pin ②
- Reverse the tractor slowly up to the implement
- Insert pin ②
- Insert lock pin ①

C



ITEM	SPEC.
TYPE	T-CD1
MAXIMUM HORIZONTAL LOAD	6,000kg
MAXIMUM VERTICAL LOAD	500daN
REAR TIRE	12.4-24 6PR (Ag) 41x14.00-20 4PR(Turf) 12.5-20 10PR(Ind)

▶ TECHNICALLY PERMISSIBLE TOWABLE MASSES

ITEM	SPEC.
UNBRAKED TOWABLE MASS	1,400kg
INDEPENDENTLY BRAKED TOWABLE MASS	6,000kg
TOWABLE MASS WHEN FITTED WITH HYDRAULIC OR PNEUMATIC BRAKING	N/A

▶ SAFETY FRAME ROPS

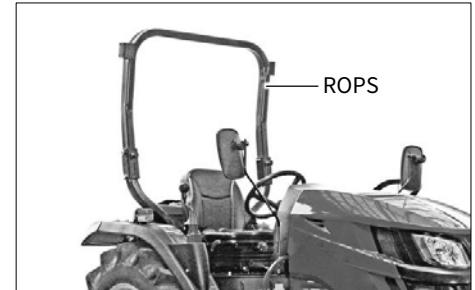

The safety frame is intended to reduce damage of an accident in case of a rollover, so it cannot prevent an accident.

Always have the safety frame installed securely for driving to ensure your safety unless going under an area with a low ceiling such as a garage.

WARNING

- If a rollover accident occurs without the safety frame, the frame cannot protect the driver, leading to a severe injury or even death. Never drive with the safety frame detached.

4. CABIN

► FIGURE OF CABIN

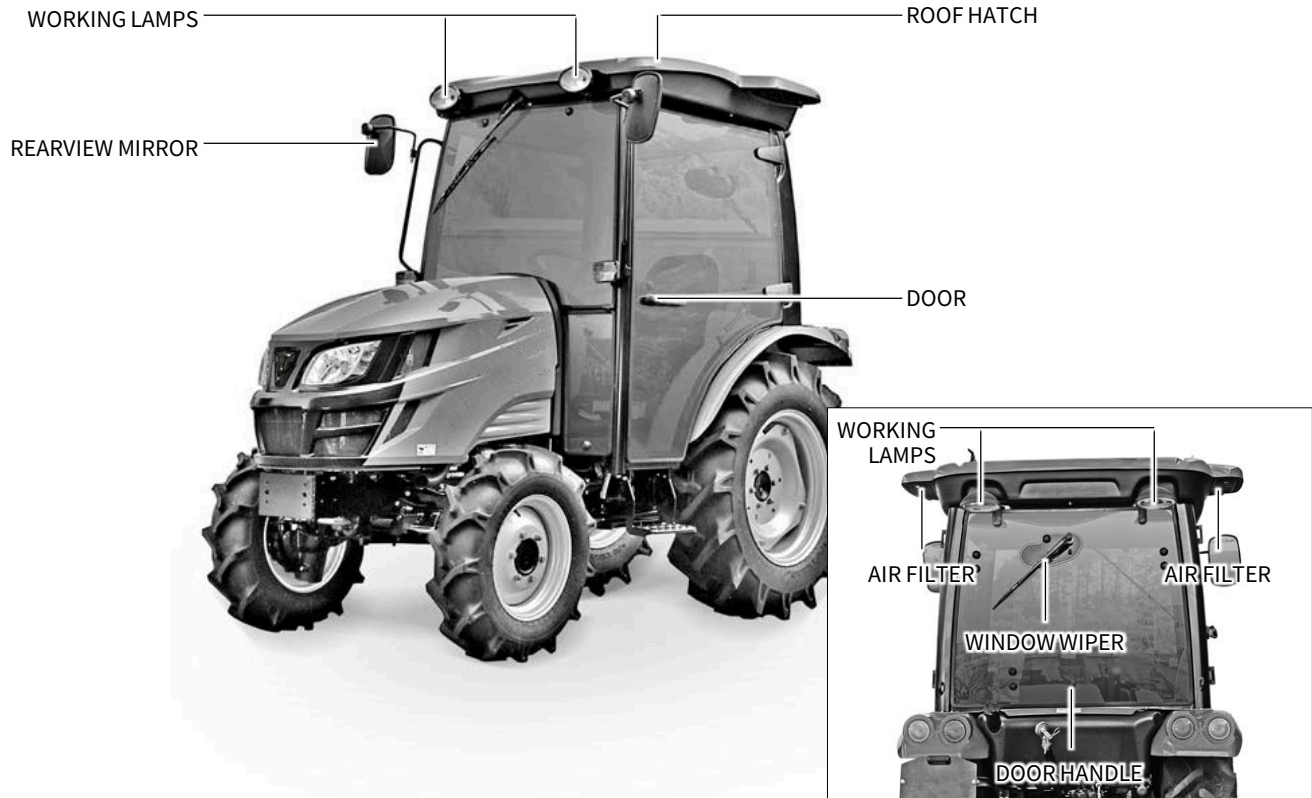

C



► MAJOR FEATURES OF CABIN

The cab fully conforms to the international standard as far as safety and soundproofing are concerned. It can be provided with ventilation, heating and air-conditioning system.

It is available in the following version:

- Cab with ventilation and heating systems.
- Cab with ventilation, heating and air-conditioning systems.



CAUTION

- The cab is in full conformity with the international standards as to the cab's soundproofing.
- Be very careful when operating in small spaces and always protect your ears whenever other working equipment is generating dangerous noise levels.
- Remember that steering, braking and operational performances are highly influenced by the implements mounted, the trailers transported and the ballasts applied to the tractor.



CAUTION

- When transporting heavy loads (Exceeding the weight of the tractor) reduce the speed under 15 Km/h (9.32 m/h).
- All the implements mounted onto the tractor must be safely secured.
- Be very careful during implement hitching and unhitching operations. When using implement supports, be sure they are suitable and sufficiently strong.

► DOOR

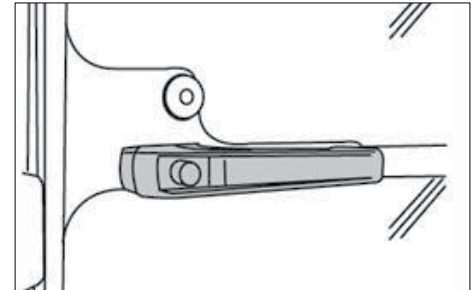

The doors are provided with key locks. To open from the outside, when unlocked, depress the push button. To open from inside, push the lever downwards.

► **REAR WINDOW**

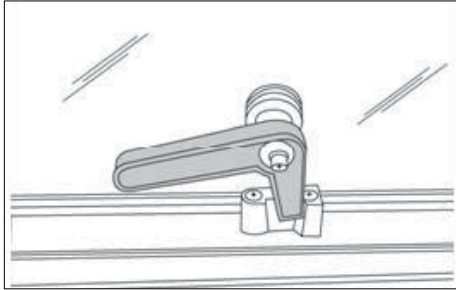

The rear window is fitted with central handle for opening. When opened it is held in place by two dampers.

► **REARVIEW MIRROR**

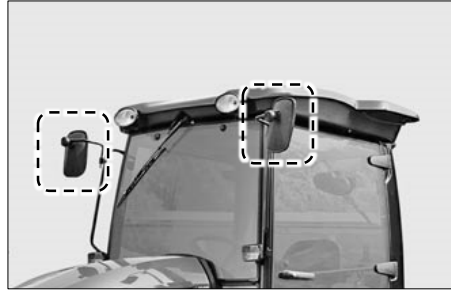

The cab is provided with rearview mirrors on both sides. They can be adjusted and folded, whenever necessary, to avoid interference with external obstacles. The mirror have a telescopic arm to allow positioning for maximum convenience by the user. Remember that mirrors must always be positioned in compliance with road traffic regulations when driving on a public highway.

► **WORKING LAMPS**

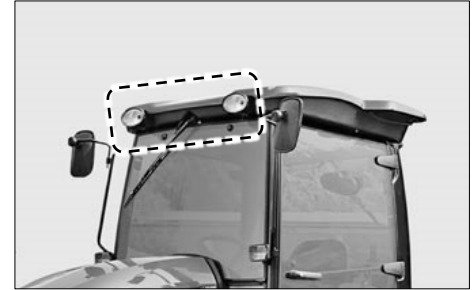

The working lamps are located on the cab roof (two in the front and two in the rear). They are switched on by means of the special switches on the roof console.

C



► CAB CEILING

The ceiling is padded with insulation material to block heat radiation into the cab and keep the temperature down when working in very sunny areas.

The cab platform is covered with a "firm grip" carpet in the most commonly used areas.

It is recommended to keep this carpet clear of earth, mud, etc. so that the operator may get on and off the tractor in full safety.

► INSIDE OF THE CABIN

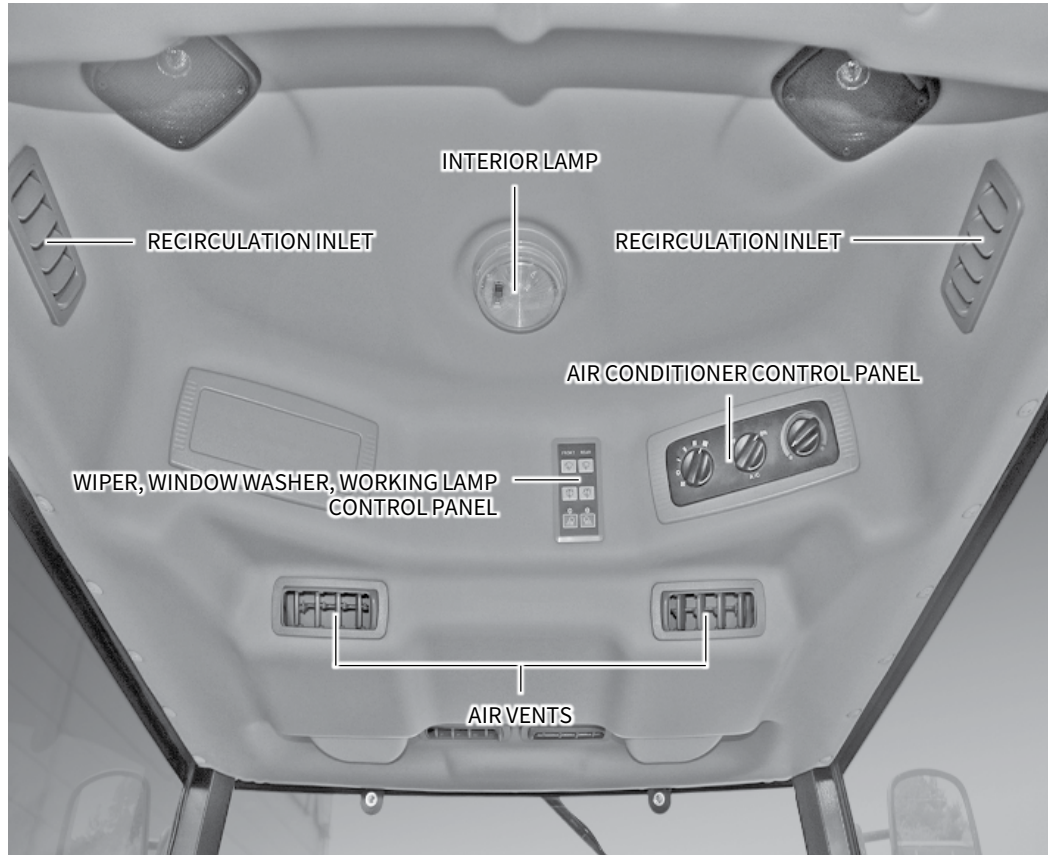

► VENTILATION

The ventilation unit is housed in the cab ceiling.

To switch it on and adjust it, turn the electrical fan switch to the desired speed.

The cab becomes slightly pressurized when the ventilation system is in operation, so that the fresh air can enter only by way of the filter installed in the rear section of the cab roof.

The fan switch can be operated only after the ignition key is inserted.

The air flow can be regulated and directed by suitable positioning the air vents.

Air can be taken in fresh from outside or recirculated from within the cab by way of the relative side inlets.

► RECIRCULATION INLETS FULLY CLOSED

Air is taken in entirely from outside the cab through the rear grille and filtered through a paper element positioned behind the grille.

IMPORTANT

- It is very important that the air vents never be completely closed so as to allow for a steady air flow.
- To obtain a greater pressurization inside the cab, it is necessary to take the air from the outside, therefore the inside air recirculating grille should be fully closed.

► WIPER, WINDOW WASHER, WORKING LAMP CONTROL PANEL

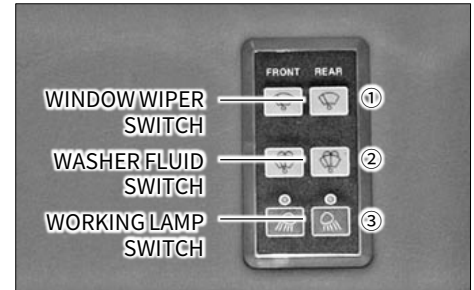

Wiper, window washer, working lamp control panel is located on right side of an operator.

1. Windows wiper switch :
Turn windows wiper on in front / rear windows.
2. Washer fluid switch :
Spray window washer fluid in front / rear windows.
3. Working lamp switch :
Turn working lamp on in front / rear side.

► **WASHER FLUID TANK**



Check the level of windscreen washer fluid in the plastic reservoir located on the rear side of tractor.
During winter it is advisable to add a suitable antifreeze or methyl alcohol to the windscreen washer fluid.

► **INTERIOR LAMP**



Push the button to light on and push it again to light off.

► **AIR CONDITIONER CONTROL**

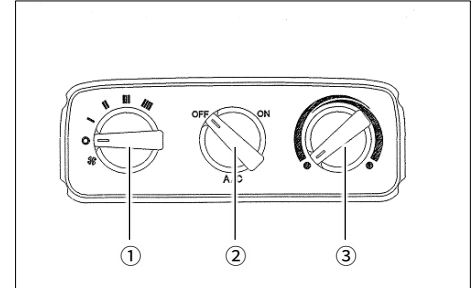

1. Blower control switch :
Air volume can be changed in 5 steps, from 0 to 4. At the '4' position, the largest air volume is obtained.
2. Power switch :
This switch can turn on/off air conditioner system.
- ON (turn right) - A/C is turned on.
- OFF (turn left) - A/C is turned off.
3. Temperature control switch :
Set this dial at the desired position to obtain the optimum air temperature.
- Turn right - to obtain warmer air.
- Turn left - to obtain cooler air.

C

To operate the air conditioner, the blower must be on.

The blower volume and temperature control and all vents must be adjusted to obtain the best cooling/heating for the ambient temperature and dust conditions.

When operating the air conditioner system, the moisture level is decreased.

IMPORTANT

- During cold weather, with ambient temperature above 32°F (0°C) operate the air conditioner at least once per month, for a period of 10 to 15 minutes. This will lubricate the seals to prevent them becoming brittle and help prevent the loss of refrigerant from the system.
- The system is equipped with an environmentally safe refrigerant, R134a. Never recharge the air conditioning system with refrigerant other than R134a as this will result in loss of cooling and permanent damage to all air conditioning components.

► HEATING SYSTEM

The heater is switched on and adjusted by rotating the control knob at the roof console, then switching on the blower and setting the selector at the preferred speed.

Warm the cab up quickly, the knob should be rotated fully clockwise and the blower set to speed 4.

The screen is demisted or defrosted by air directed through a slot vent. For defrost or fast demist, all other vents should be closed off.

IMPORTANT

- Ventilation is provided by a single blower unit serving both the heating system and the air conditioning system.
- After reaching the desired temperature adjust the system to suit your needs.

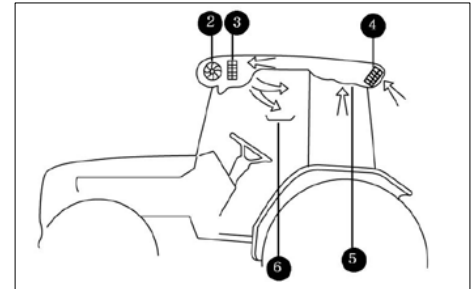

2. Speed heating fan
3. Electric resistances
4. Air filter
5. Recirculation inlets
6. Air vents

WARNING

- Before starting the engine, make sure the system is off (by turning off the ventilation fan) so as not to overload the battery.
- After the system at full power for a long period of time, never turn it off suddenly but let it first idle for about 20 seconds.

IMPORTANT

- For ideal system operation, the engine must run at 1,000 rpm.

► **HEATING SYSTEM CONFIGURATION**

The heating system consist of two units:

1. Heater and blower unit installed behind roof console.
2. Power supplying set, consisting of an auxiliary alternator located front of the engine and driven by a belt directly linked to the engine pulley. If the air does not come out from the diffusers right away as soon as the system is started, turn off immediately and identify the fault.

IMPORTANT

- Never turn on the heating system when working in dusty environments.

► **HEATING AIR CONDITIONER SYSTEM**

The system is designed to ensure optimum temperature inside the ca and maximum comfort and safety for the operator.

However, it is advisable to consult our specialized workshops whenever repairs or adjustments need to be performed.

Do not approach the system with open flames, as any escape from the circuit may produce a lethal gas.

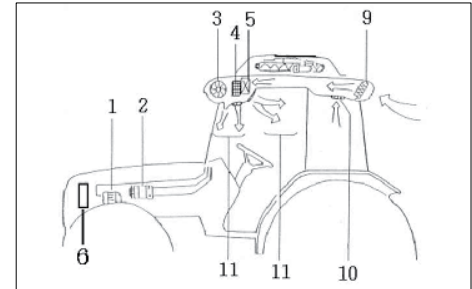

1. Alternator
2. Compressor
3. Speed fan
4. Electric resistance
5. Evaporator
6. Condenser
9. Air filter
10. Recirculation inlets
11. Air vents

► **CIRCULATION AIR VENTS**

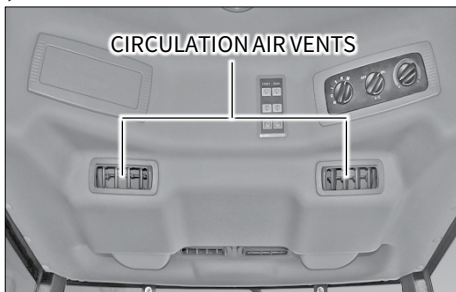

With the circulation vent set in any position outside Air will still be pulled into the cab.

► **CABIN AIR INTAKE FILTER**

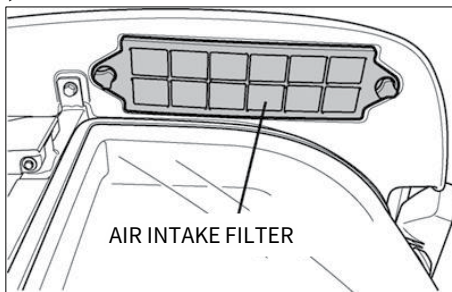

The "paper" filter is not suitable for the treatment of pesticides and so must be replaced by an "active carbon" filter available optionally. Once the pesticide treatment is finished, it is necessary to once again replace the "Active carbon" filter with the paper filter, since this is the only type suited for filtering foreign particles from the air.

 **WARNING**

- Cab air filters remove dust in the air, but are not capable of removing chemicals used in spraying crops or in weed control. Many chemicals used for these purposes are toxic when improperly used, and can be hazardous to operators and others in the area. Follow the instructions of manufacturers of both the equipment and the chemicals regarding prohibition of dust or spray, personal hygiene practices, and other precautions noted by the manufacturers.

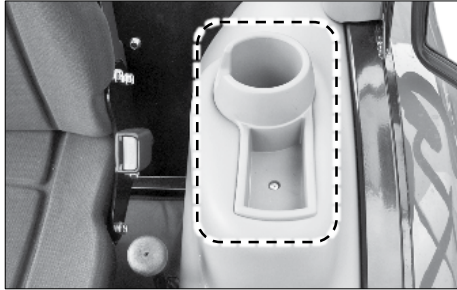
▶ CUP HOLDER, TRAY

Put the bottles and personal belongings.

▶ CHECKING THE AIR CONDITIONING SYSTEM

1. Economic friendly refrigerant :
R134a : 0.7~0.85kg (1.54~1.87 lbs.)

The presence of air and water in the system could jeopardize its efficiency.

- The air is uselessly compressed by the compressor and no cooling effect is produced.
 - The moisture has a tendency rise to obstructions which prevent the cooling efficiency.
2. Check belt tension:
when finger pressure is applied to the mid-point between both pulleys.
 3. Condenser fins must always be duly clean using water or an air set.

▶ CHECKING THE AIR CONDITIONING SYSTEM CHARGE

1. Check the refrigerant charge.
 - Run the engine at 1,500 rpm.
 - Set the air conditioning system in the coldest for 5 minutes.
 - Check the sight glass clear or cloud.
2. Check the refrigerant with receive drier sight glass.

⚠ CAUTION

- If the air conditioner is operated with not charged, the lubrication in the compressor can cause the damage.



▶ HOW TO CHECK THE AIR CONDITIONING SYSTEM WITH THE NEEDLE OF HIGH-LOW GAUGE

To connect with manifold pressure gauge can find the cause of air conditioning system.

Because manifold pressure gauge is various sensibly. (Ambient Temp. is based on 30 ~ 35°C(86 ~ 95°F))



CAUTION

- Operating engine RPM 1500~2000 is must, and so to that you can check the correct cause and air conditioning. (In case below the figure of indicated pressure gauge has some clearance, confirm with approximate indicated needle data.)

▶ GAGUE PRESSURE CONVERSION

- $\text{lb/in}^2 = \text{PSI}$
- $1 \text{ kgf/cm}^2 = 14.22 \text{ lb/in}^2$
ex) 200 PSI = 14 kgf/cm^2

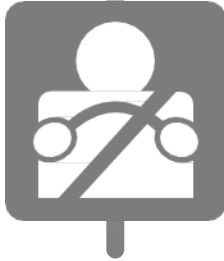

D. OPERATION

1. START & STOP OF ENGINE D – 2
2. OPERATING TRACTOR D – 4
3. OPERATION OF PTO D – 7
4. OPERATION OF DPF D – 9
5. IMPLEMENTS D – 11
6. TOWING THE TRACTOR D – 13
7. CHECKS DURING DRIVING D – 15
8. WORK PROCEDURES D – 17
9. OPERATION TIPS D – 23
10. HOW TO USE OF JACKS D – 28

1. START & STOP OF ENGINE

▶ HOW TO START ENGINE

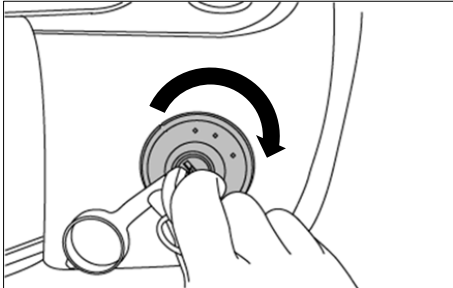

1. Make sure that there is no obstacle around the tractor.
2. Seat on the driver's seat and confirm that the parking brake is applied.
3. Check that each shift lever and PTO switch are in the neutral position.
4. Pull the throttle lever halfway.
5. Depress the clutch pedal. The safety switch is activated.
6. Insert the key into the main switch and turn the switch to the "ON" position. Check that the engine oil lamp and charge warning lamp come on.
7. Turn the main switch to the "START" position. When the engine

is started, release the switch.

8. Confirm that all monitoring lamps go off after the engine is started.

IMPORTANT

- Never turn the key to 「start」 position while engine is running as this can cause serious damage to starter and engine flywheel.
- Avoiding running the start motor over 10 second. It consumes lots of current.
- If engine cannot be started within 10 second, wait for 30 second and try it again.
- Especially in cold weather, always allow the tractor to idle for a while to warm up and build up for a while to warm up and build up sufficient oil pressure to ensure normal operating temperature for longer engine life.

WARNING

- Never start engine by connecting start motor terminal or safety switch directly. The tractor may move suddenly and cause an accident.

▶ RUNNING-IN PERIOD

Make sure to keep the following instructions for the initial 50-hour use.

1. Avoid abrupt starting and abrupt stopping.
2. Do not use excessive speed or load.
3. Drive the tractor only when the engine is sufficiently warm.
4. Do not idle the engine at the maximum speed.
5. Check each part and change oil and fluid after 50-hour use.
6. Refer to the section Maintenance for adding and changing engine oil.

▶ **STOPPING ENGINE**



1. Idle engine before stopping it.
2. Turn the key switch to 「OFF」 position.
3. Remove the key from the switch.

IMPORTANT

- Do not stop the engine at a high speed.
- If the engine has been running for an extended period of time, stop the engine only after idling it for 5 to 10 minutes.

▶ **ENGINE IDLING**

After starting engine, idle engine for 5~10 minute so that oil is delivered to each part of engine.

IMPORTANT

- If the engine is loaded right after it is started, it may cause engine stalling and failure. Make sure to idle the engine first.
- If neglecting to idle the engine, it can cause:
 - ✓ Seizure of the hydraulic pump
 - ✓ Failure in the hydraulic system.

WARNING

- Make sure to apply the parking brake while idling the engine.
- Never idle the engine in a poorly ventilated area. It can cause carbon monoxide poisoning by emissions.

▶ **IDLING IN COLD WEATHER**

Hydraulic oil in this vehicle is also used as transmission fluid.

If the temperature drops in winter so oil gets cold, its viscosity rises and the hydraulic pump cannot suck oil in, causing malfunction.

Make sure to idle the engine in winter according to the following instructions.

TEMPERATURE	TIME
32°F or higher (0°C or higher)	At least 10 min
32°F ~ 14°F (- 0°C ~ - 10°C)	10 ~ 20 min.
14°F ~ - 4°F (- 10°C ~ -20°C)	20 ~ 30 min.
- 4°F or less (- 20°C or less)	more than 30 min.

WARNING

- Proper ventilation is needed when engine idling is performed indoors.

D

2. OPERATING TRACTOR

▶ STARTING OFF

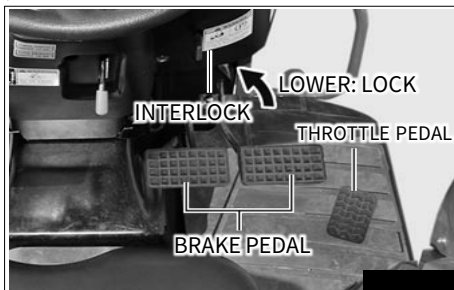

1. Confirm that left and right brake pedals are interlocked when two brake pedals are installed. Make sure to interlock left and right brake pedals unless working in a field.
2. Lift an implement.
3. Place main and sub shift lever into the desired position.
4. Depress brake pedal to release parking brake.
5. Release the clutch pedal slowly while depressing the throttle pedal to increase the engine speed.

▶ SHIFTING AND DRIVING

To shift during driving, depress the brake pedal to stop the vehicle in advance.

WARNING

- The driving speed in the reverse direction is almost the same to the speed in the forward direction. Make sure to check the surroundings carefully when driving backward.
- Especially, never drive backwards with the sub shift lever in the position high speed. The driving speed becomes faster and it can cause an accident.
- Connect the left and right brake pedals when it is about to drive when two brake pedals are installed.

▶ TURNING IN FIELD

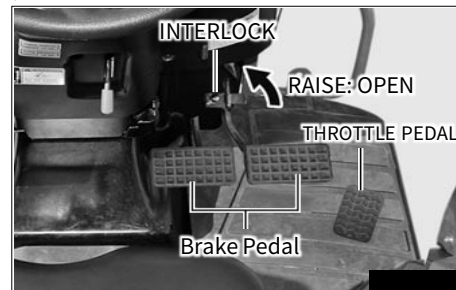

When two brake pedals are installed.

1. To turn in a field, release hook for left and right brake pedals.
2. Turn steering wheel and depress brake pedal for desired direction.
3. While turning, keep engine speed low and turn slowly.

When single brake pedal is installed.
Turn steering wheel to desired direction.

WARNING

- Avoid turning at a high speed. The tractor can fall on its side.
- When the tractor is installed with an implement, its overall length becomes large. Be extra care with other people and objects around when turning.

► **PARKING THE TRACTOR**

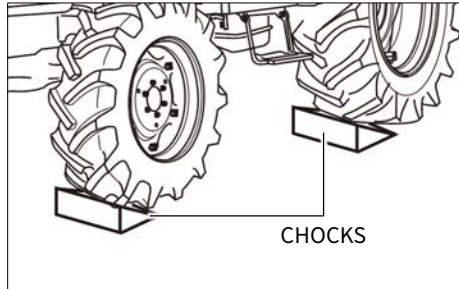

1. Stop tractor completely in level ground.
2. If an implement is attached to vehicle, lower it.
3. Set levers in neutral position.
4. Apply parking brake.
5. If an implement is attached to the tractor, lower it.
6. Remove key from key switch.

 **WARNING**

- After parking, make sure to apply the parking brake.
- Avoid parking on a slope if possible. If it is absolutely necessary to park on a slope, chock the rear wheels.

► **START ON STEEP SLOPE**

1. Depress the brake pedals.
2. Depress the clutch pedal to disengage the clutch.
3. Place each shift lever in the low speed position.
4. Set the engine at the mid speed with the throttle lever.
5. Release the clutch pedal slowly and keep it depressed halfway.
6. Release the brake pedal slowly at the same time.
7. Pull the throttle lever again to rev up the engine. Then, release the brake and clutch pedals together to start off.

► **TIPS FOR DRIVING ON SLOPE**

1. Set range shift lever in low speed position on a slope to prevent engine from stopping.
2. Keep driving speed low on a downhill road.
3. Do not set sub shift lever in neutral position on a downhill road.

 **IMPORTANT**

- When the needle on the coolant temperature gauge is pointing at 「H」 or coolant lamp comes on, engine is overheated. If running the engine under this condition continuously, the engine parts can be severely damaged. Make sure to take an appropriate action immediately.

 **WARNING**

- On a downhill road, use the engine brake. Otherwise, it can cause an accident.



▶ CAUTIONS FOR DRIVING INTO OR OUT OF FIELD

1. Check that left and right brake pedals are connected.
2. It is dangerous to drive into/out of a field if the field is deep from its bank. Use ramps.
3. Move in the perpendicular direction to the bank.
4. When driving out of the field, lower the implement so that the front wheels cannot be lifted.
5. It is recommended to drive into a field backward to utilize full power.

WARNING

- Be careful to keep the tractor's balance when working on a slope. The tractor may become out of balance and roll over.
- It is very dangerous to ride a person as a front weight.

▶ LOADING TO OR UNLOADING FROM TRUCK

1. When loading the tractor onto a truck, drive backward.
2. Be extra careful when using ramps.
3. If the engine stops on ramps, depress the brake pedals immediately and release them slowly to move onto the ground. Then, start the engine again to climb the ramps again.

▶ CAUTIONS FOR DRIVING ON ROAD

1. When changing the direction on a road, use the turn signal lamp to inform other drivers.
2. Use the low beam when there is any vehicle coming on the other side at nighttime.
3. Check that the left and right brake pedals are connected.
4. Keep the work lamps off when driving at night.
5. Follow any applicable laws and keep safe driving.
6. Never let anyone ride the tractor, except yourself as a driver.

WARNING

- If driving on a road with an implement attached, the front side of the tractor tends to be lifted and vehicle may not be steered properly.

3. OPERATION OF PTO

Rear PTO is provided for variable utility. The engine will not start if PTO switch is ON position.

The engine will shut-off if the operator leaves the seat with parking brake released and PTO engaged.

PTO	PTO speed
REAR	540 RPM

WARNING

- To avoid damage of transmission and implement, do not engage PTO with the engine running at high speed.
- Do not operate any implement at a high speed than is specified for it.
- When making adjustments to the implement, stop the engine to avoid serious injury.
- When leaving the tractor stop the engine and remove the key. Apply parking brake.

▶ **OPERATING PTO**

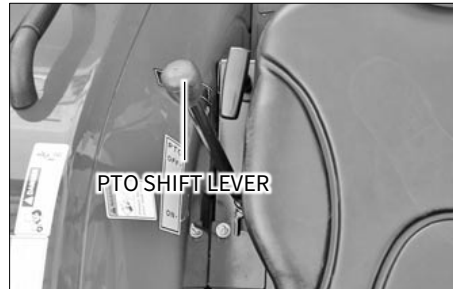

Follow next steps to use PTO.

1. Decrease engine speed to near idle.
2. Change PTO mode switch and / or PTO shift lever to desired positions.
3. Turn on the PTO switch.
4. Increase engine speed to desired speed.

▶ **PTO LAMP**



PTO monitor lamp indicates the state of the PTO shaft.

- **If the PTO lamp glows:**
The PTO is rotating.
- **If the PTO lamp blinks:**
The PTO is stopped but will rotate when an implement is raised. (option)
- **If the PTO lamp is off:**
The PTO is off.

D

**► PTO ROTATION TABLE**

N/A : not applicable

PTO SWITCH	PTO MODE SWITCH	PTO SHIFT LEVER	POSITION OF IMPLEMENT	PTO LAMP	PTO SHAFT ROTATING
OFF	N/A			OFF	OFF
N/A	OFF	N/A		OFF	OFF
N/A		OFF	N/A	OFF	OFF
ON	AUTO	ON	RAISED	BLINK	OFF
ON	AUTO	ON	LOWERED	ON	ON
ON	MANUAL	ON	N/A	ON	ON

- From the table above we learn about the safety features of the PTO. When the monitor on the dash panel is blinking it indicates to the operator that the PTO is in the on position but temporarily not rotating because the implement is lifted off the ground or both. The PTO will start rotating instantaneously when the implement is lowered to the ground.
- The operator must use this blinking signal to clear the area around the tractor off bystanders/onlookers as the rotating blades of certain implements can accidentally cause injuries to the persons standing near the tractor.
- The stopping of the PTO when the implement is lifted off the ground with the position control prevents the damage to the implement or the PTO shaft.

⚠ WARNING

- When the PTO mode switch is in manual position the PTO does not stop rotating. If working on hard soils, pavements with a rotary implement the PTO ON/OFF switch must be put to the OFF position to stop the PTO from rotating. If this is not done, the rotating blades of the implement will push on the hard ground below and in turn push the tractor toward causing accident which can lead to serious injuries or death.
- Extra precaution must be taken to clear the area of bystanders/onlookers when using PTO driven implements. The rotating blades of the implements can cause serious injuries on contact. The warning that is indicated by the blinking PTO monitor is to make the operator aware that the PTO is in on position and will instantly start rotating if the implement is lowered or both.
- In no case the specified rotating speeds indicated by the implement manufacturer be crossed as the same can lead to serious damage to the tractor/equipment and can lead to serious injuries to persons around.



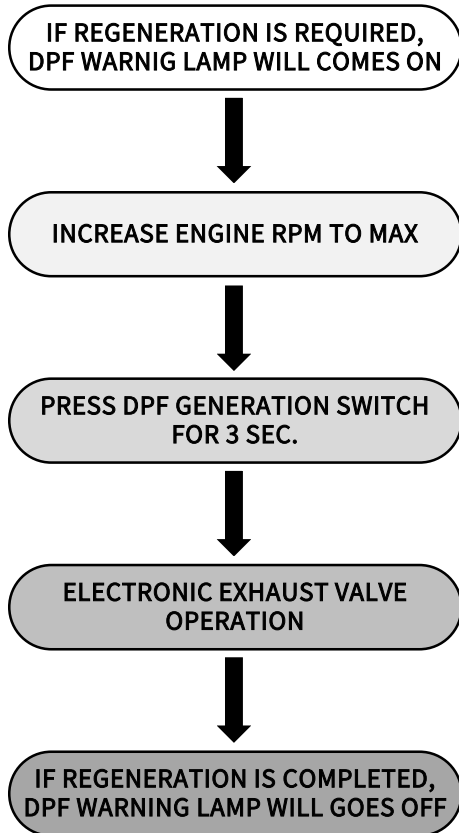

4. OPERATION OF DPF

▶ OPERATION SEQUENCE OF DPF PROCESS













▶ LAMPS RELATED TO DPF PROCESS BUZZING

- Cleaning logic (30% valve operation) is performed at every key-on after electronic exhaust valve leaning.









PROCESS	LAMP STATUS	BUZZING STATUS
DPF REGENERATION PROCESS REQUIRED	 ON	BUZZING 3 TIMES [1 sec. – 1 sec. – 1 sec] BUZZING AGAIN IN 1 MIN.
DPF REGENERATION PROCESS START		BUZZING 1 TIME [2 sec.]
DURING DPF REGENERATION PROCESS	 ON  ON  BLINKING	
DPF REGENERATION COMPLETE	ALL LAMPS GO OFF	BUZZING 3 TIMES [1 sec. – 1 sec. – 1 sec]

D

**▶ ABNORMAL OPERATION DURING DPF REGENERATION PROCESS**

ISSUE		LAMP	LAMP STATUS
COOLANT TEMPERATURE OVER 105°C DURING DPF REGENERATION PROCESS		  	[ON] + [ON] + [BLINK]
RELEASE MODE	REGENERATION FAILED	 	[BLINK] + [BLINK]
	RELEASE MODE	 	[BLINK] + [BLINK]
	FORCE RELEASE	  	[BLINK] + [BLINK] + [BLINK]

▶ ENGINE AND DPF MALFUNCTION

ISSUE		LAMP	LAMP STATUS
ENGINE SENSOR FAULT	RPM	 + RPM OFF	[ON]
	COOLANT TEMPERATURE	 + COOLANT TEMP OFF	[ON]
ELECTRONIC EXHAUST VALVE FAULT		 	[BLINK] + [BLINK]
DPF FAIL	DPF DAMAGE	 	[ON] + [ON]
	DPF REMOVAL	 	[ON] + [ON]

5. IMPLEMENTS

► CONNECTION TO IMPLEMENTS

1. Make sure to stop the engine before connecting the implements.
2. Move the double acting valve lever forward and backward for 4 to 5 times to release pressure in the hydraulic line of tractor. Otherwise, it is hard to connect the couplers, and hydraulic fluid can be sprayed from the line and get in to your eyes while connecting them.
3. Remove any foreign material around male and female couplers. If foreign material enters the hydraulic components, it can lead to malfunction of the system.
4. Open dust-proof cover of female coupler of the tractor and insert the male coupler of the implement. A clicking sound is heard when the couplers are engaged.

5. Pull the hydraulic hose of the implement to check that the couplers are properly connected.
6. Start the engine and check the operating status and leakage.

IMPORTANT

- Hydraulic control valves may not exist depending on tractor model.

► DISCONNECTION TO IMPLEMENTS

1. Make sure to stop the engine before disconnecting it.
2. Release any residual pressure in the hydraulic hoses of the implement and tractor by operating the double acting valve lever 4 to 5 times.
3. Remove any foreign material around the couplers.
4. Keep the implement balanced by removing any load applied (lowering it onto the ground, for example). If disconnecting the hose while outer load is applied to the implement, it is hard to connect the implement in the future.
5. Remove the male coupler by pushing the female coupler boss of the tractor backward.



6. Close the dust-proof cover of the female coupler of the tractor. Wrap the male coupler of the implement with a plastic bag to prevent contamination.

WARNING

- Never connect or disconnect the implement hydraulic hose while the pressure in it is not released or the engine is running. It's hard to connect and disconnect the hose and hydraulic fluid can be sprayed from the hose, and get into your eyes or skin.
- Stop engine and wear protective glasses and gloves before work.

► MOUNTING IMPLEMENT

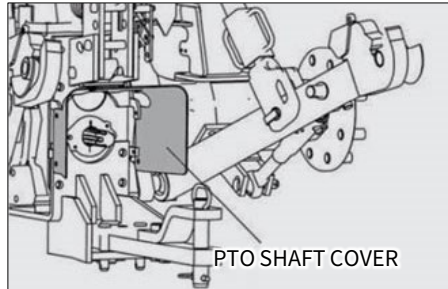

If the PTO is used, remove the safety cover off the PTO shaft. Adjust the yoke rod on the lower links to suit the implement in use. Attach the left lower link, then attach the right lower link using the adjusting handle on the leveling box if required. Attach the top link. Attach the PTO shaft to the tractor if used, making sure that it is locked in place. Adjust the check chains to suit the implement and tighten the locknuts. To remove an implement reverses the procedure.

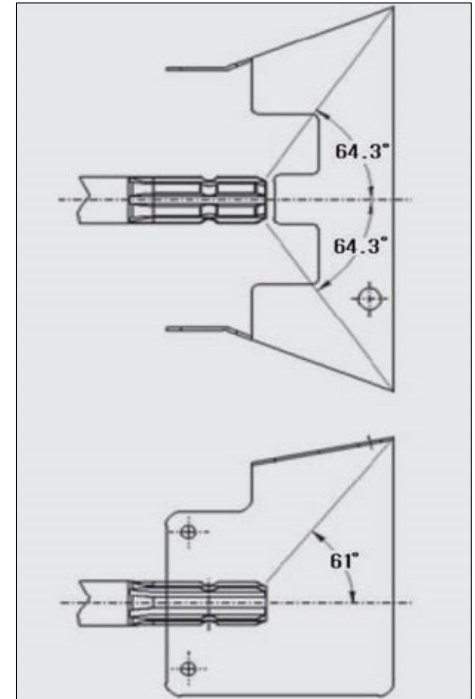

CAUTION

- Do not attach a PTO shaft with the engine running and ensure all safety shields are in place.

6. TOWING THE TRACTOR

► TOWING THE TRACTOR

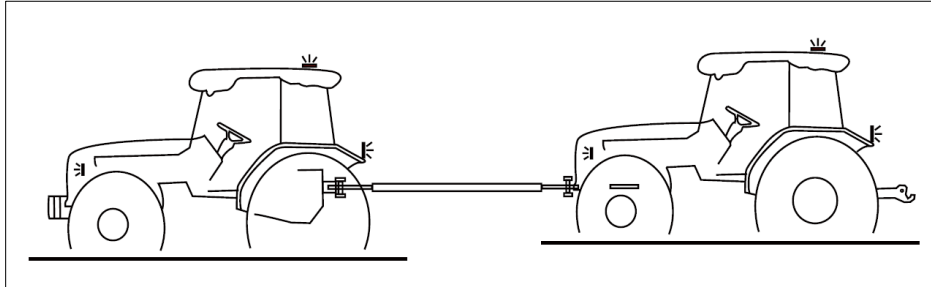

The tractor can be towed only for short distances, such as, for example, from inside to outside a building.

A broken down tractor should be towed for the minimum indispensable distance to remove it from potentially dangerous conditions.

Observe all legal provisions as envisaged in the highway code relative to national legislation regarding towing manoeuvres.

DANGER

- NEVER permit other persons to access the tractor operator position during towing.

WARNING

- We recommend transporting the tractor on a low loader in the case of longer transport distances. Comply with the maximum width and height regulations for road transport. Check that the loader is suitable for the weight of the tractor to be transported.

CAUTION

- An operator must always be at the tractor's controls when the tractor is being towed.

► TOWING WITH ENGINE RUNNING

Towing with the engine running can be performed if forced gearbox lubrication is ensured:

- Engine speed between 1,200 – 1,300 rpm.
- Maximum towing speed 8km/h
- Maximum towing distance 1km

For towing the tractor use only a standard bar applied to the front towing hitch approved by the manufacturer.

Make sure to use the correct pin for the towing hitch and that it is secured with its locking pin.

Clean all lights required for road use, front and rear, and make sure they are in working order.

Before starting towing check the following conditions:

- Unhitch any implement from the tractor;
- Lock the two brake pedals together with the connecting latch;
- Disengage the power take-off and differential locks;



- Set the shuttle control lever and gear lever to neutral;
- Move the sub shift lever to the high speed position;
- Move the creeper lever to neutral;
- Display the SMV (Slow Moving Vehicle) sign and turn on the rotating beacon and hazard lights

During road transfers observe the following instructions:

- Wait until traffic thins before joining the road.
Exert caution in the proximity of unregulated intersections.
Slow down until you have a clear view in both directions.
- Keep in your lane and drive as close as possible to the curb.
- If a tailback builds up behind you pull into a lay-by as soon as possible to allow the traffic to pass
- When stopping the tractor (in any circumstances) apply the parking brake.

Travel speed must always be such as to allow complete control and stability of the tractor in all conditions.

DANGER

- Never attempt to tow the tractor with ropes (including steel ropes) because rope breakage can cause serious injury.

WARNING

- Switch on the hazard warning lights and revolving warning lights.
Affix suitable notices indicating that the tractor is being towed.
Observe and follow the relevant national regulations.
Observe local safety regulations.

► TOWING WITH ENGINE OFF

With engine stopped and with forced gearbox lubrication system inoperative the tractor should not be towed except when safety is at risk.

IMPORTANT

- With engine stopped and with forced gearbox lubrication system inoperative the tractor can be transferred to a service center only when loaded onto a transporter.

7. CHECKS DURING DRIVING

► CHECK DURING DRIVING

Constantly monitor the warning lamps on the monitor panel and if any comes on, stop the tractor to determine the cause.

► OIL PRESSURE

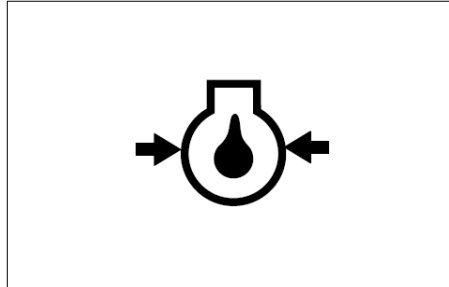

If the oil pressure lamp comes on check the oil level first of all.

If the oil level is OK, ask a qualified dealer to check the reason for the lamp coming on.

► BATTERY CHARGING

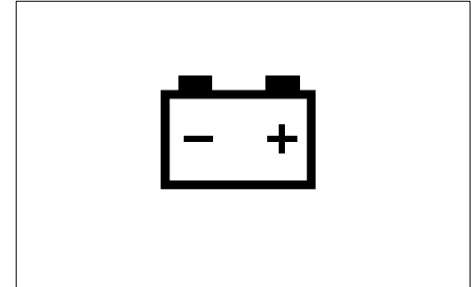

If the alternator warning lamp comes on check all connections and ensure that the fan belt is not broken.

If all connections and the fan belt are intact consult your dealer to determine the cause of the problem.



► FUEL GAUGE



To avoid excessive condensation in the fuel tank refill at the end of each day's work and ensure during the day that it does not drop to a low level where the fuel system will require bleeding to expel air in the system after refilling the tank.

► COOLANT TEMPERATURE



If the coolant warning lamp comes on, the engine is over-heated.

Stop the tractor and check followings:

- Radiator coolant
- Radiator fin for clogging
- Fan belt for looseness

If necessary, have your tractor checked by workshop.



DANGER

- Allow the engine to cool down before opening radiator cap as serious burns may result due to hot steam and boiling water.

8. WORK PROCEDURES

► PRECAUTIONS FOR HANDLING IMPLEMENTS

1. When driving the tractor to attach or detach an implement, make sure that there is no one in between or around the tractor and implement.
2. Install and remove the implement only on safe and level ground.
3. When installing a heavy implement, install weight on the front to keep balance.
4. When adjusting an implement, apply the parking brake, stop the engine and set the PTO switch in the OFF position in advance.
5. To tow anything, use the towing hitch only.
6. When working with a front loader, install an implement to the back to keep balance (if necessary).

WARNING

- Read instructions on warning decals on each implement thoroughly before work.
- To avoid an injury due to mishandling of an implement, read the user's manual of the implement thoroughly and work safely and precisely with caution.
- Installation of an improper implement can lead to an injury. Install only implements specified by the manufacturer.

► GENERAL IMPLEMENT

<Safety precautions for rotavator>

Never remove the safety cover of the rotavator.

Do not remove the PTO shaft cover and safety cover on the universal joint.

When adjusting each part, disengage the PTO and stop the engine in advance.

When driving on a road, keep the PTO disengaged.

Also, keep the rotavator lowered on a road as long as it does not hit the ground.

For the universal joint, its inner shaft and outer shaft should be overlapped at least 15 cm.

Check that the universal joint is firmly fixed to the tractor and rotavator shaft.

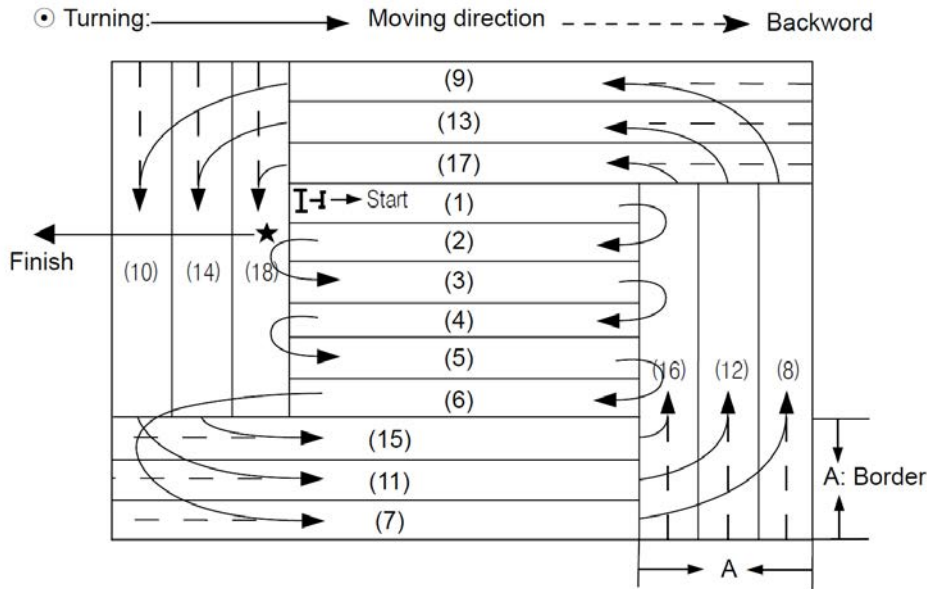

1. Sequential returning plowing pattern

- This pattern can be useful in a well-planned field in a good condition.
- The border shown in the figure is the effective plowing width of the rotavator and should be set a little narrower than three times of one plowing width.
- The starting point is the ending point.
- Plow in a sequential pattern from (1) to (6) and in a circular pattern from (7) to (18).
- When driving forward to plow, have the bank on the right side.
- Be careful not to press already plowed soil with the wheels.

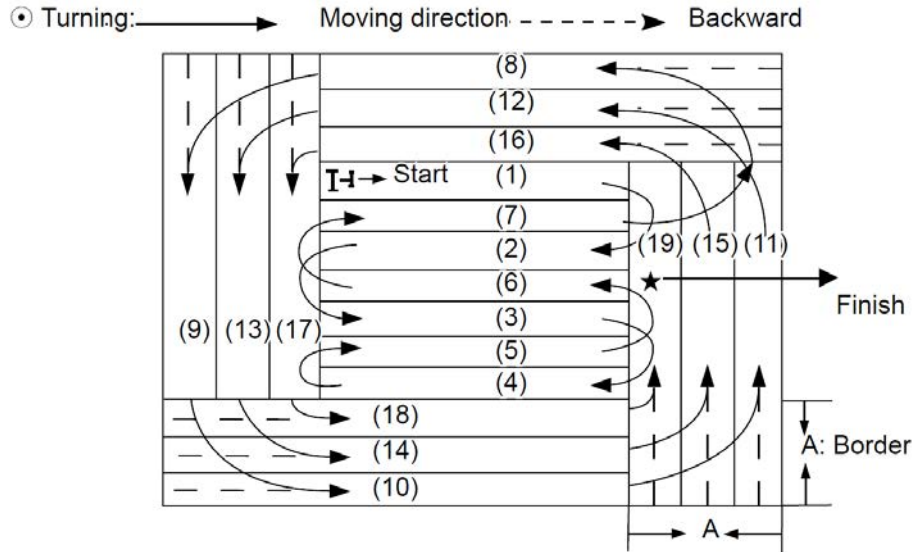

2. Alternating returning plowing pattern

- This pattern is useful for narrow or short fields or poorly planned fields in which are not easy to turn.
- In the figure, the plowing width for (1), (2), (3) and (4) should be overlapped with the one for (5), (6) and (7) for approx. 10 cm.
- For the sections (1) to (7), perform plowing in an alternating pattern. For the sections (8) to (19), plow in a circular pattern.
- Refer to the sequential returning pattern for other details.

D

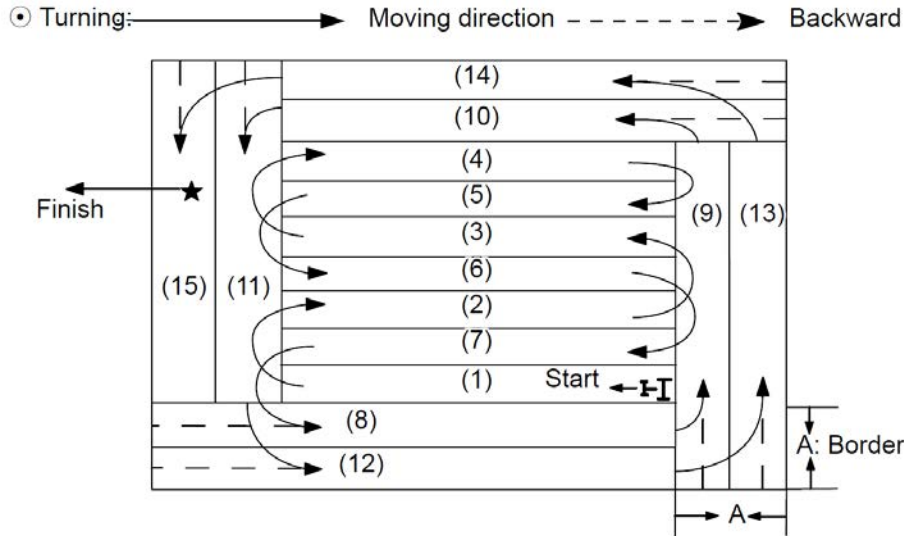

3. Land leveling pattern

- The land leveling work may be performed after crushing soil or not.
- The vehicle speed can be set faster when performing the land leveling work with soil crushed already.
- When working in a wet field, fill the field with a sufficient amount of water so that the trace of plowing cannot be seen.
- The border shown in the figure should be set a little narrower than two times of one plowing width.
- Refer to the alternating returning pattern for other details.

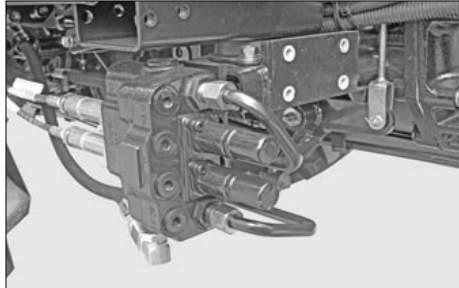
▶ FRONT LOADER

When installing for loader, the loader should be facing up, but a loader the left when not installed.

⚠ WARNING

- When connecting the hydraulic pipes, set them according to the operating directions specified on the label attached to the side of the joystick lever.
- Abnormal operation of a loader can lead to an accident.

⚠ IMPORTANT

- If it is hard to steer the tractor for plowing as the front wheels are lifted, install additional weight to the front. (if no loader is installed.)

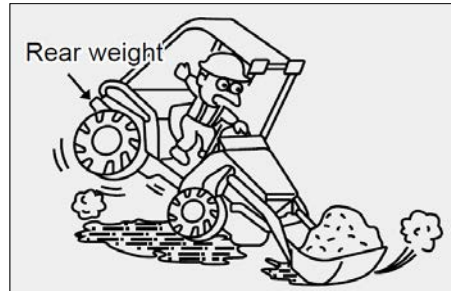

Keep the balance between the front and rear by installing a weight to the back of the tractor or attaching a weight or implement using the 3-point link.

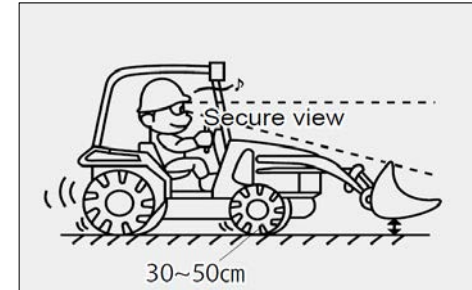

When transporting things with a loader, lower the loader and keep the driving speed slow.

Keep the loader 30 to 50 cm off the ground and the driving speed below 5 km/h.

When going onto a slope or unpaved area, lower the speed and drive with care.

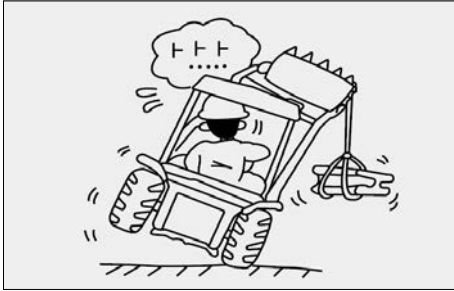

Do not lift anything only with one side of the tractor. If so, the tractor may fall on its side.
Make sure to distribute the load evenly.

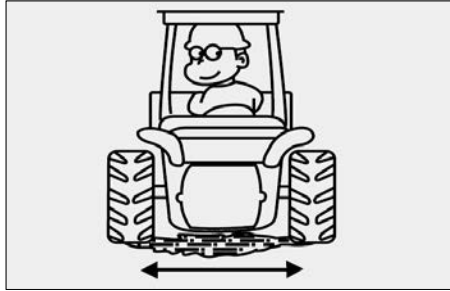

Keep the clearance between the rear wheels as large as possible for safety of the tractor.



 **WARNING**

- Do not let anyone ride a loader for work, such as spreading fertilizer. He/she may fall off the loader, leading to an injury or even death.
- Always lower the loader to the ground before leaving the tractor.

 **IMPORTANT**

- This chapter only provides brief descriptions and instructions for a rotavator and loader. Therefore, for detailed operational instructions and other descriptions, refer to the user's manual of each implement.

9. OPERATION TIPS

To save fuel & oil in your tractor, following things should always be kept in mind.

► AIR CLEANING SYSTEM

1. Clean the air cleaner regularly so that dust does not settle down.
2. For every 50 hours & every day in sandy/dusty conditions.
 - Clean the air cleaner filter element with compressed air.
 - If the rubber ring is cut or expanded then change it with an appropriate one.
Fix the rubber at the proper location & check for leakages if any.
 - If air is leaking through the hose connection, check & rectify other leakages, too.

IMPORTANT

- If air cleaning system is not properly maintained, it will lead to early wear of piston rings & sleeves. This will lead to problems like loss of engine power, excessive oil consumption fuel consumption.

► ENGINE

1. Put the engine oil on load after the engine is heated & the water temperature gauge indicates the needle to be in the green zone.
2. If excessive black smoke is visible, then the paper element of air cleaner, Fuel injection pump or nozzles should be checked.
3. Do not run the engine without load for more than 2 minutes. It is better to stop the engine rather than run it idle. This will help in saving of fuel.



► BRAKE

1. If the tractor has to be stopped for a long period, it is advisable to bring the transmission in neutral position.
2. Do not override the brake pedals.
3. While coming down from a slope, reduce the engine throttle & use low gear.
Do not depend only on the brakes for stoppage.

► OIL SYSTEM

1. Always use recommended grade of oil.
2. Every day before starting the engine, check the oil level with a dipstick & refill between the minimum & maximum level.
3. Change the engine oil.
Replace filter & O-ring, as & when required.

► LUBRICATING OIL

• GENERAL

Modern diesel engines place very high demands on the lubricating oil to be used. The specific engine performances which have increased constantly over the last few years lead to an increased thermal load on the lubricating oil. The lubricating oil is also more exposed to contamination due to reduced oil consumption and longer oil change intervals. For this reason it is necessary to observe requirements and recommendations described in this operating manual in order not to shorten the life of the engine. Lubricating oils always consist of a base oil and an additive package. The most important tasks of a lubricating oil (e.g. wear protection, corrosion protection, neutralization of acids from combustion products, prevention of coke and soot deposits on the engine parts) are assumed by the additives. The properties of the base oil are also decisive for the quality of the

product, e.g. with regard to thermal load capacity. In principle, all engine oils of the same specification can be mixed. However, mixing of engine oils should be avoided because the worst properties of the mixture are always dominant.

• **VISCOSITY**

The ambient temperature at the installation site or in the application area of the engine is decisive for choosing the right viscosity class. Too high a viscosity can lead to starting difficulties, too low a viscosity can endanger the lubrication effect and cause high lubricating oil consumption. The viscosity is classified according to SAE. Multipurpose lubricating oils should be used basically.

+ **IMPORTANT**

- The prescribed lubricating oil quality must be observed when selecting the viscosity class.

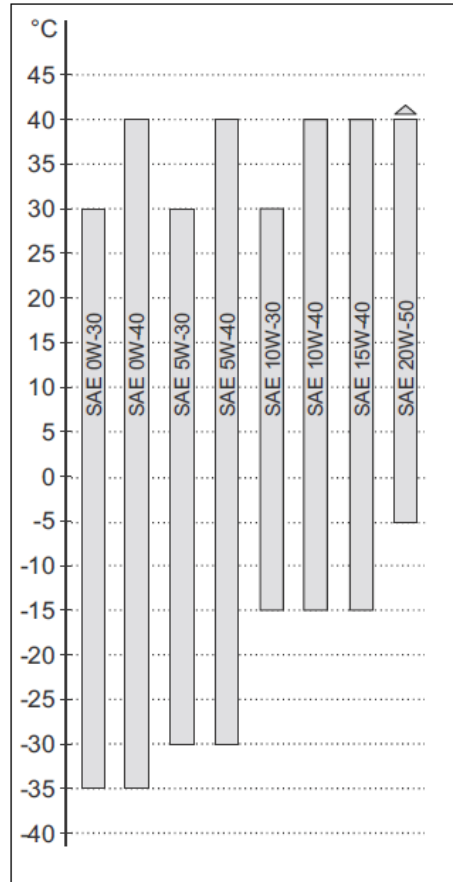

1. Always use filtered diesel for the fuel system.
2. At the end of the day's working, it is preferable to fill the diesel tank so that it may prevent condensation.
3. Change the filter, if the system gets choked.

D

Do not change both the filters at the same time.

If the above directives are not adhered to, the fuel injection pump & injection nozzle will lose its life early.

Also, it will lead to excessive black smoke & excessive diesel consumption.



► WINTER OPERATION WITH DIESEL FUEL

Special demands are placed on the cold behavior (temperature limit value of the filterability) for winter operation.

Suitable fuels are available at filling stations in winter.

At low ambient temperatures paraffin discharges can lead to blockages in the fuel system and cause operating faults.

⚠ IMPORTANT

- For engines with common rail injection, the mixing of petroleum and adding of extra low additives is not permissible.

► COOLING SYSTEM

1. Check the fan belt tension regularly. Adjust, if required.
2. Check the coolant level in the radiator fins always clean.
3. Replace the radiator cap with a genuine cap only, if required.
4. Do not remove the thermostat but replace with a new one, if required.
5. Do not change the radiator water often.

► OTHERS

In liquid-cooled engines, the coolant must be conditioned and monitored, otherwise the engine could be damaged by:

- Corrosion
- Cavitation
- Freezing
- Overheating

► OPERATING TIPS FOR POWER STEERING WHEEL

1. Operate the power steering wheel only while the engine is running. You may feel the steering wheel heavier with a low engine speed.
2. When an implement, such as a loader, is attached to the front, the steering wheel may be felt heavy with the tractor stopped. If so, operate the steering wheel while driving the tractor at a low speed.
3. When the steering wheel is completely turned to one end, the safety valve is activated to output the audible signal (relief sound). When this sounds, avoid using the steering wheel (O.K. only for a short time). Also, never turn the steering wheel completely continuously.
4. Turning the steering wheel to its end unnecessarily (with the tractor stopped) can wear tires rapidly.
5. In winter, warm up the engine sufficiently before use.
6. When repairing components, such as a pipe, make sure that no foreign material enters the system.
7. The steering wheel can be operated with a small amount of force. Therefore, operate it with care and keep your hands on it at all times.

WARNING

- Releasing the steering wheel during driving can result in a collision and rollover. Never release the steering wheel during driving.

10. HOW TO USE OF JACKS

Front axle



If the tractor must be lifted for servicing, take it to a suitably equipped workshop.

Carry out the following operations before any operation about the tractor. Engage the four-wheel drive, the first gear and the parking brake and put chocks to the wheels touching the ground.

Before lifting the tractor, avoid its swinging by means of wooden wedges applied to the front axle

Rear axle

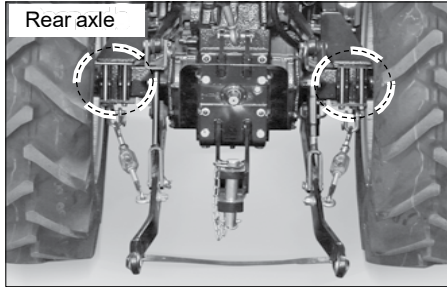

Use jack lifts of suitable capacity and apply them at the centre of the front and rear axles and paying due attention to weight distribution.

No decals for the lifting point are applied on the tractor, as they would be, too difficult to apply in the available spaces and would be all too easily removed or effaced during normal operation of the tractor.

IMPORTANT

- Apply the jack lift to the lifting points according to the type of operation and following the safety procedures given before.



E. MAINTENANCE

1. MAINTENANCE SCHEDULE E – 2
2. OPENING COVERS E – 4
3. CHECKS & SERVICING EACH PART E – 5
4. GREASING EACH PART E – 21
5. STORING THE TRACTOR E – 22



1. MAINTENANCE SCHEDULE

▶ PERIODICAL CHECK AND SERVICE SCHEDULE TABLE

■ Check or adjust each part only when engine is stopped.
 ■ When any hot part should be serviced, wait until it is cooled down.

○ : Check · Add · Adjust ● : Replace
 ★ : Replace at first time only △ : Clean

INSPECTION PART	TIME OF USE											YEAR		REMARK	
	50	100	150	200	250	300	350	400	450	500	550	1	2		
ENGINE OIL LEVEL	CHECK ENGINE OIL LEVEL BEFORE WORK														
ENGINE OIL & FILTER	★					●					●	●		EVERY 250HR OR 1 YEAR	
FUEL FILTER										●					
FULE HOSE & BAND										○			●	EVERY 2 YEAR	
AIR CLEANER ELEMENT		△		△		△		△		●				EVERY 500HR	
AIR CLEANER HOSE & BAND										○			●	EVERY 2 YEAR	
INLET HOSE & BAND										○			●	EVERY 2 YEAR	
COOLANT													●	EVERY 2 YEAR	
COOLANT LEVEL	CHECK COOLANT LEVEL BEFORE WORK														CHECK BEFORE WORK
RADIATOR & RADIATOR NET	CLEAN RADIATOR & RADIATOR NET BEFORE WORK														CLEAN BEFORE WORK
RADIATOR HOSE & BAND										○			●	EVERY 2 YEAR	
FAN BELT & A/C BELT					○					○				IF IT IS NEEDED	
BATTERY		○		○		○		○		○				IF IT IS NEEDED	

Check or adjust each part only when engine is stopped.
When any hot part should be serviced, wait until it is cooled down.

○ : Check · Add · Adjust ● : Replace
 ★ : Replace at first time only △ : Clean

	INSPECTION PART	TIME OF USAGE												REMARKS	
		50	100	150	200	250	300	350	400	450	500	550	600		
C H A S S I S	TRANSMISSION FLUID	★										●		REPLACE EVERY 500 HOUR	
	HYDRAULIC OIL FILTER	★										●			
	FRONT AXLE OIL	★										●			
	TOE-IN	GET SERVICED BY WORKSHOP EVERY 300HR												2 ~ 6mm (0.08 - 0.24 in.)	
	GREASING EACH PART	ADD EVERY 50 HOUR, DAILY IF WORKING IN WET FIELD													
	BRAKE PEDAL PLAY	CHECK FREQUENTLY BEFORE DRIVING (CHECK SIMULTANEOUS OPERATION OF LEFT AND RIGHT BRAKE PEDALS)												PLAY : 30 ~ 40mm (1.18 in. ~ 1.57 in.)	
	CLUTCH PEDAL PLAY	CHECK FREQUENTLY BEFORE DRIVING												PLAY : 20 ~ 30mm (0.79 in. ~ 1.18 in.)	
	TIGHTNESS OF FRONT & REAR WHEELS	CHECK FREQUENTLY BEFORE DRIVING													
	ADJUSTING THROTTLE SYSTEM						○							○	
	RUBBER HOSES					○						○			
CHECKING ELECTRIC WIRING	○			○			○				○			EVERY YEAR	

E

2. OPENING COVERS

▶ OPENING HOOD

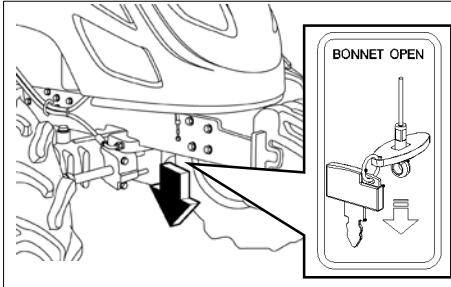

With the hood up, Hook release lever can be removed by pulling downward, having first detached the hood lamp wiring harness.
Hood can be open by itself.



Lift the hood with hands.
Then, the hood is automatically opened and fixed by its damper.

3. CHECKS & SERVICING EACH PART

► INSPECTION ITEMS

To prevent any possible failure, some items should be checked daily.

Make sure to perform inspection before driving.

Inspect each part in the following order:

1. Check the items that were faulty yesterday.
 - Lamps for proper illumination and damage
 - Tires for inflation pressure, crack, damage and wear
 - Rotating parts for loose bolts and nuts
 - Transmission fluid level
 - Implement attachment status
2. Go around the tractor and check:
 - Lamps for proper illumination and damage
 - Tires for inflation pressure, crack, damage and wear
 - Rotating parts for loose bolts and nuts
 - Transmission fluid level
 - Implement attachment status
3. Open the hood and check:
 - Engine oil level
 - Coolant level
 - Fan belt for looseness and damage
4. Sit on the driver's seat, turn the key switch to the "ON" position and check:
 - Fuel gauge for proper operation
 - Fuel level
 - Engine oil and charge warning lamps for blinking operation
 - Turn signal lamp
 - Horn operation
 - Brake pedal free play
5. Start the engine, drive the tractor slowly and check:
 - Emission color
 - Brake pedal operation
 - One brake pedal operation
 - Steering wheel for heaviness and vibration
 - Coolant gauge operation
 - Hydraulic operation of three point linkage

► **ENGINE COOLANT INSPECTION AND CHANGE**

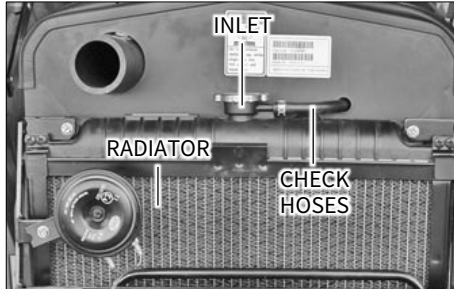

<Inspection>

Open the radiator cap and check that the radiator is filled with coolant up to its filler inlet.

If the coolant amount is insufficient, add more coolant.

⚠ WARNING

- Do not open the cap when the engine is hot. Otherwise, hot steam can burn you seriously. Wait until the engine is sufficiently cooled down.

<Change>

1. To drain coolant, open the drain cock and radiator cap as well for faster draining.
At this time, place the heater cock in the opening position.
2. Wash the inside of the radiator with clean water thoroughly.
3. Fit the drain cock and add coolant.
4. Start and idle the engine for approx. 5 minutes.
Then, check coolant in the reservoir tank and add more coolant as necessary.

If coolant freezes, the engine can be damaged.

- Clean the radiator thoroughly before adding antifreeze.
- The mixture ratio of antifreeze is different by manufacturers and temperature.
Refer to the manufacturer's manual.
- Mix antifreeze with water sufficiently before adding it.
- Adding antifreeze
 - If evaporated :
Add water for the reduced amount.
 - If leaked :
Add mixture of antifreeze and water with the same mixture ratio.

⚠ CAUTION

- If engine coolant gets on your skin, it can irritate the skin and cause a skin condition.
Make sure to clean your skin with soap and water or hand cleaner thoroughly.

► **CLEANING RADIATOR AND CONDENSER GRILLES**

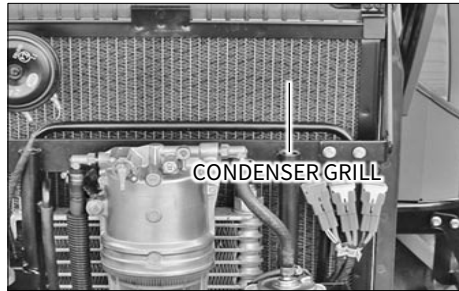

When working in a grassy field or working at night, the radiator or condenser grille may be clogged by grass, straws or bugs, reducing cooling performance.

In this case, clean the grille. If dust is stuck between the fan and tube, flush the area with clean water.

+ **IMPORTANT**

- Do not clean the radiator fin with water jet. It can deform the fin.

► **CHECKING AND CHANGING ENGINE OIL**

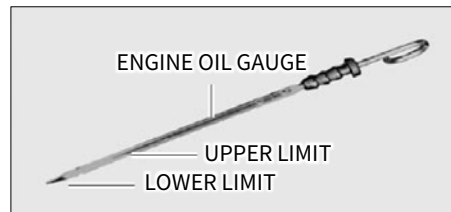
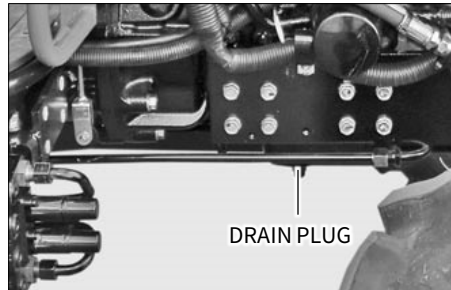
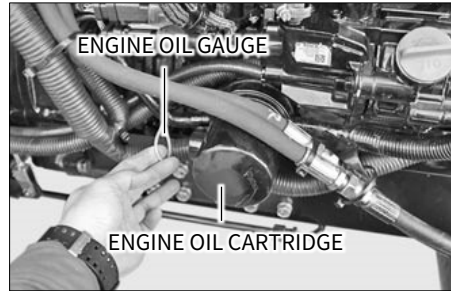

<Inspection>

1. Pull out the dipstick, wipe its tip and insert it again. Then, pull it out and check that the oil level is between the upper and lower limits.
2. If insufficient, add oil.

<Changing>

1. Unscrew the drain plug on the lower section of the engine to drain contaminated engine oil. Since hot oil flows out of the engine first, be careful not to get burnt.
2. After draining oil, tighten the engine oil drain plug.
3. Add the specified amount of the specified engine oil through the filler hole.

CAUTION

- If engine oil gets on your skin, it can irritate the skin and cause a skin condition.
Make sure to clean your skin with soap and water or hand cleaner thoroughly.
- Make sure to cool down the engine sufficiently before draining oil.
Oil is very hot and can cause a burn if changing oil right after the engine is stopped.

IMPORTANT

- Do not add engine oil over the upper limit level.
- Check the engine oil before starting the engine or at least in 5 minutes after the engine is stopped.
- When trying to use new oil from a different manufacturer or oil with different viscosity, drain used oil completely before adding new oil.

▶ CHECKING AND CHANGING TRANSMISSION FLUID

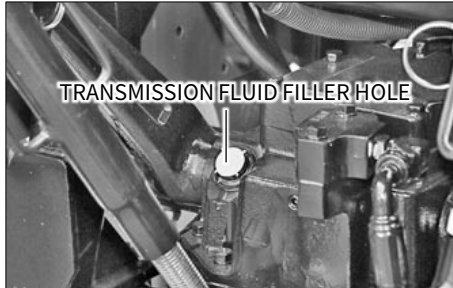

<Inspection>

Perform inspection with the engine stopped.

1. Check the transmission fluid level through the sight glass to see if the level is between the upper and lower limits.
2. If insufficient, add oil.

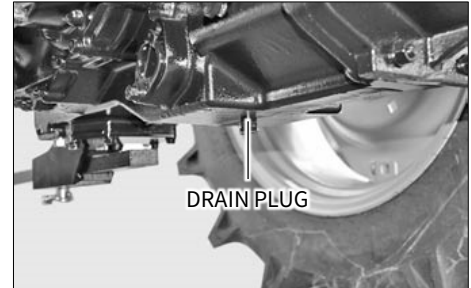
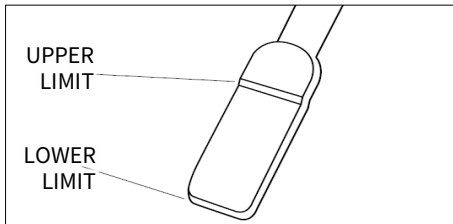

<Changing>

1. Unscrew the drain plug on the lower section of the transmission to drain contaminated transmission fluid.
Since hot fluid flows out of the engine first, be careful not to get burnt.
2. After draining fluid, tighten the transmission fluid drain plug.
3. Add the specified amount of the specified transmission fluid through the filler hole.

CAUTION

- If transmission fluid gets on your skin, it can irritate the skin and cause a skin condition. Make sure to clean your skin with soap and water or hand cleaner thoroughly.

IMPORTANT

- Do not add fluid over the upper limit level.
- Check the fluid before starting the engine or at least in 5 minutes after the engine is stopped.
- When trying to use new fluid from a different manufacturer or fluid with different viscosity, drain used fluid completely before adding new fluid.

► **CHECKING AND CHANGING FRONT AXLE OIL**

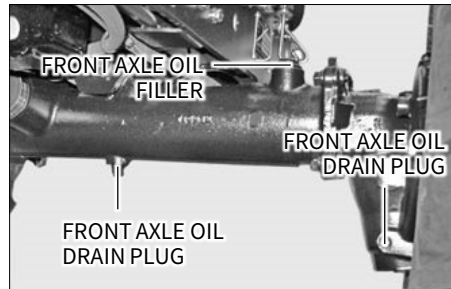

<Inspection>

1. Pull out the dipstick, wipe its tip and insert it again. Then, pull it out and check that the oil level is between the upper and lower limits.
2. If insufficient, add oil.

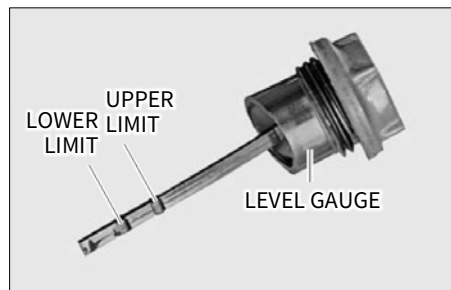

<Changing>

1. Unscrew the drain plugs on the bottom of the axle and left/right final cases to drain engine oil. Since hot fluid flows out of the engine first, be careful not to get burnt.
2. After draining oil, tighten the oil drain plug.
3. Add the specified amount of the specified oil through the filler hole.

CAUTION

- If oil gets on your skin, it can irritate the skin and cause a skin condition. Make sure to clean your skin with soap and water or hand cleaner thoroughly.
- Make sure to cool down the engine sufficiently before draining oil. Oil is very hot and can cause a burn if changing oil right after the engine is stopped.

E

IMPORTANT

- Do not add front axle oil over the upper limit level.
- Check the front axle oil before starting the engine or at least in 5 minutes after the engine is stopped.
- When trying to use new oil from a different manufacturer or oil with different viscosity, drain used oil completely before adding new oil.

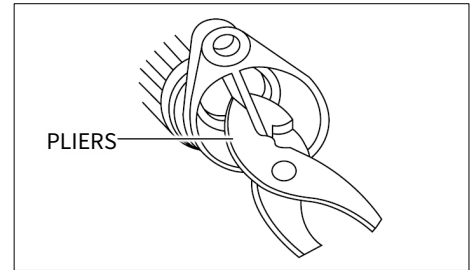
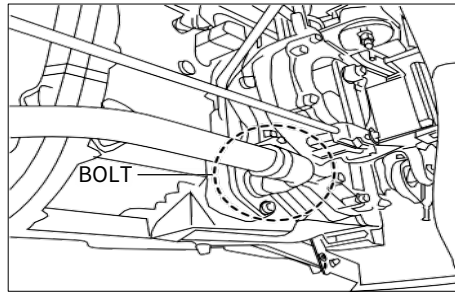
► TRANSMISSION STRAINER CLEANING

1. When changing transmission fluid, clean with diesel fuel.
2. Unscrew the filter body support bolt from the right lower section of the rear transmission case and gently pull the filter with pliers to remove it.

► **REPLACING ENGINE OIL FILTER CARTRIDGE**

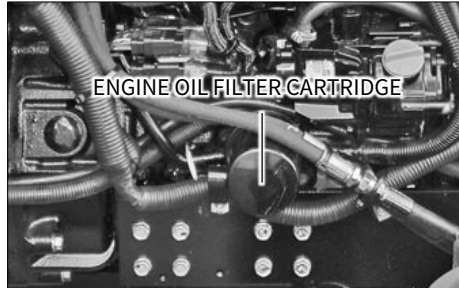

1. Remove the engine oil filter cartridge by turning it counterclockwise with a wrench.
2. Apply a thin film of oil to the O-ring of a new cartridge and install the new cartridge by tightening it with a hand.
When its packing touches the sealing surface, turn it approx. 2/3 turns further with a wrench.
3. Put the engine oil to the specified level in new oil filter cartridge.
4. Run the engine for approx. 5 minutes and check for proper operation through the engine oil warning lamp.
Then, stop the engine. (This warning lamp should be turned off while the engine is running.)
5. Check the oil level with the dipstick again.
If still insufficient, add more.

► **FUEL TANK**



Use only low sulfur or ultra-low sulfur diesel fuel.

+ **IMPORTANT**

- If foreign materials, such as dust and sand, or water are mixed in fuel, it can deteriorate the performance of the fuel injection pump.
Make sure to add quality fuel through the strainer.

E

▶ BLEEDING FUEL SYSTEM

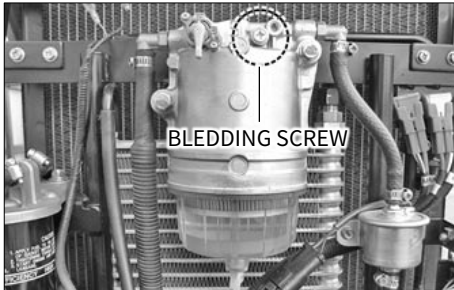

It is necessary to bleed the system under the following conditions.

- The engine is stopped due to the empty fuel tank.
- The filter or pipe is removed.

<Instruction for bleeding fuel system>

1. Unscrew the bleeding screw.
2. Start the engine.
3. When clean fuel flows out of the bleeding screw, tighten the screw.
4. Repeat the procedure if the system is not bled completely.

▶ FUEL FILTER CLEANING AND ELEMENT REPLACING

This filter is to remove foreign material and water from fuel.

1. Set the fuel filter cock to the 'OFF' position.
2. Loosen the ring screw on top of the cap to remove the cap.
3. Flush the element with diesel fuel to remove any foreign material from it.
4. If the element is severely contaminated, replace it with a new one.

⚠ IMPORTANT

- Clean or replace the fuel filter every 100 hours of operation.

▶ VACUUM VALVE CLEANING

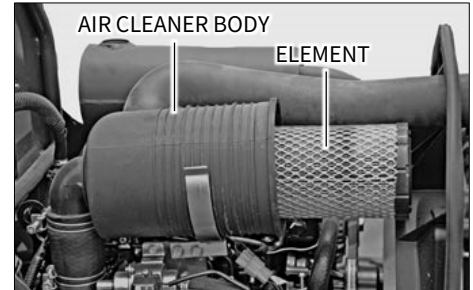

Pull out the valve with a hand and remove dust from its inside. If it is dirty or watery, wipe it with a dry rag thoroughly before fitting it again.

<Cautions for inspection and service of air cleaner>

1. Use the standard element and filter and do not apply oil on them.
2. Remove any dust in the cover thoroughly.
3. Install it firmly so that dust does not enter below the cover.
4. Never drive with the element and filter removed.

► **AIR CLEANER CLEANING AND REPLACING**

<CLEANING>

Blow compressed air from the inside toward the outside of the element. Keep proper distance between the air nozzle and element.

<REPLACING>

After cleaning the element 5 times or if it is damaged, replace it with a new one.

IMPORTANT

- Do not hit the element with a rock or concrete during its cleaning.
- Make sure to install the element firmly.
- Tighten each part of the air cleaner securely to block dust completely.

► **CHECKING HOSES**

Rubber parts, such as the fuel hose and radiator hose, are aged by time even when the tractor is not in use. Therefore, such parts should be replaced with their tightening bands every 2 years or when they are damaged.

IMPORTANT

- If any fuel hose is damaged, fuel leaks and it can catch fire. Make sure to check the fuel hose and take a necessary action.

► **CHECKING BATTERY**

1. Checking battery charging level If the battery is not used for over two weeks, it may become hard to start the engine. Charge the battery in this case.
2. If the battery terminal is corroded, it cannot deliver current. If it is corroded or contaminated, wipe it with sandpaper or a brush.

BATTERY SPECIFICATION

12V 80AH (20HR)

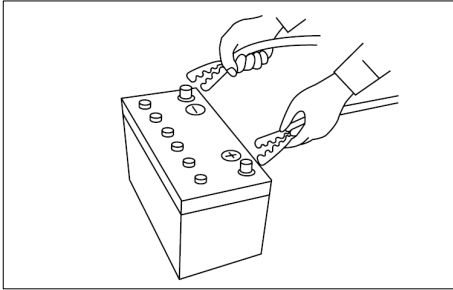
▶ BATTERY CHARGING

1. Turn the ignition switch to the "OFF" position and remove the battery from the tractor.
2. Charge the battery in a well-ventilated area.
3. Charge the battery with the normal procedures and avoid quick charging.
4. Turn the charger switch OFF and connect the cables to the negative and positive battery terminals correctly.
5. When using a charger, its charging current should be below 10 A.

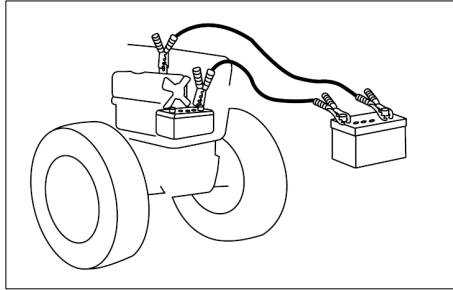
▶ BATTERY JUMP START

1. Turn off all electric devices.
2. Connect the positive terminal of the normal battery to the positive terminal of the discharged battery with the jump cable.
3. Connect the negative terminal of the normal battery to the engine body of the tractor for the discharged battery with the jump cable.
4. Firstly, start the engine of the vehicle with the normal battery. Then, start the engine of tractor with the discharged battery.
5. After the engine is started, disconnect the negative cable first. Then, disconnect the positive cable.

6. Charge the discharged battery for approx. 30 minutes after the engine is started.

⚠ DANGER

- When charging the battery after removing it from the tractor, it produces hydrogen gas, presenting a fire risk. Charge the battery only in a well-ventilated area.
- The battery produces highly flammable hydrogen gas which can explode. Keep flammable items and spark away from the battery.
- The battery electrolyte is sulfuric acid so can burn your skin and eyes. Be careful not to spill any.
- If the battery electrolyte gets on your eyes, skin, clothes or object, rinse it with water thoroughly. If you swallowed it, drink a lot of water. Also, get medical attention immediately if acid contacts your eye or is swallowed.

⚠ WARNING

- Make sure to connect the positive terminal first and connect the negative terminal to the engine body of the tractor with the discharged battery.

► **BATTERY DISCONNECTING**

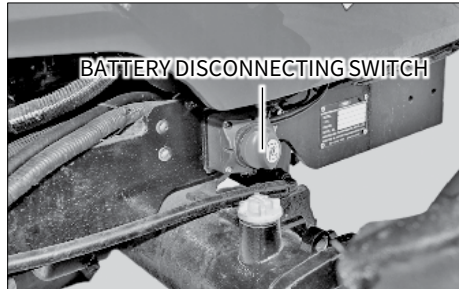

The function of the battery disconnect switch is to disconnect the power supply to the electrical system by interrupting the connection to the battery.

This has benefits for tractor safety and operation, in particular:

1. Protects the electrical system against short circuit;
2. Reduced battery self-discharge when the tractor left idle for prolonged periods;
3. Allows maintenance and repairs to be carried out in conditions of safety.

Turn the knob to “OFF” to disconnect the battery and back to “ON” to resume normal operation.

The battery disconnect knob is located on a bracket to the right of the battery. Putting the battery disconnect in safety condition The battery disconnect knob may be removed for safety purposes in the manner described below.

<Removal of the knob>

1. Turn the knob to the “off” position; the knob cannot be removed in this position.
2. Press the knob in and continue to turn it counter-clockwise as far as it will go.
3. Remove the knob.

<Refitting the knob>

1. Refit the knob
2. Press and turn the knob clockwise, positioning it at 45°

► **CHECKING ELECTRIC WIRING**

1. Loose wiring terminals can cause contact failure and damaged wiring can lead to performance deterioration of electric devices, short circuit and fire. Replace or repair aged and damaged wirings.
2. If wiring sheath is peeled off, wrap wiring with insulating tape.
3. If fasteners or bands to fix wirings are damaged, fix wirings with clamps.
4. Have wiring checked by your workshop once a year regularly to avoid fire.

E

► **CHECKING AND REPLACING FUSE**

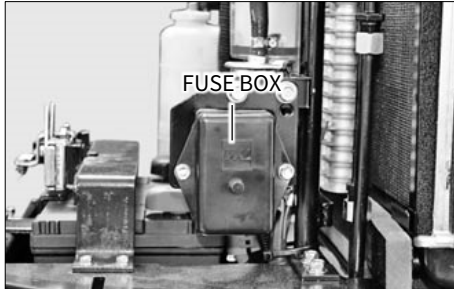

<Body fuse box>

Fuses are installed in this tractor to prevent any possible accident in case of wiring circuit malfunction.

If the electric system is malfunctioning during driving, check for any blown fuse.

1. Remove the cover of the fuse box.
2. Remove the blown fuse.
3. Fit a new fuse with the same capacity.
4. The function and capacity of each fuse are indicated on the cover of the fuse box.

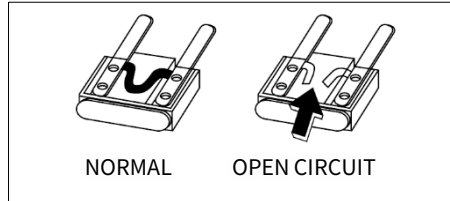

NORMAL OPEN CIRCUIT

SPARE 10A		SPARE 15A		
PANEL 15A	LIGHT/HORN 15A	WARNING LIGHT 10A	STOP LAMP 10A	TURN SIGNAL 10A
CONTROLLER 15A	ENGINE STOP 10A	○ PULLER		
FUEL PUMP 10A	COUPLER 15A		AUTO ROLLING 10A	CHECK TURN 10A
SPARE 10A		SPARE 15A		

WARNING

- If using fuses other than the specified, wirings can be overheated, leading to a fire. Never use a fuse with different capacity. Also, never use a steel wire or foil instead of a fuse.

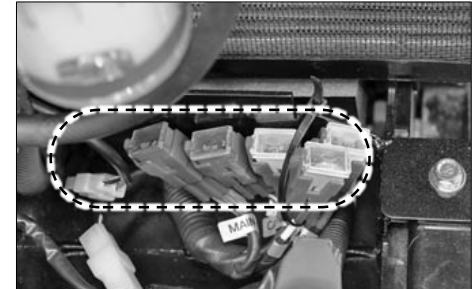

<High capacity fuse (50A)>

This tractor is equipped with three fuses for wiring.

These fuses are blown to cut current to the electric circuit in order to protect wiring. Find the cause for blown fuses and replace them with the specified genuine parts.

<INSPECTION>

Check the fuse through the transparent window to see if it is blown.

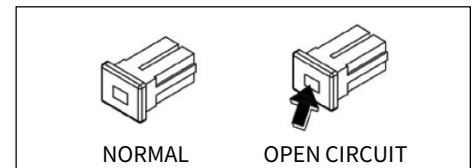

NORMAL OPEN CIRCUIT

► REPLACING LAMP BULB

If a lamp does not come on by operating the corresponding switch:

1. Check the corresponding fuse.
2. If the fuse is intact, remove the bulb socket from the lamp.
3. Remove the bulb from the socket and check for blown filament.
4. If the filament is blown, replace the bulb with a new bulb with the same capacity.

BULB	SPEC.
HEADLAMP	12V H4 50W/40W
TURN SIGNAL LAMP (FRONT)	12V 21W
TURN SIGNAL LAMP (REAR)	12V 21W
POSITION LAMP (FRONT)	12V 5W
STOP LAMP/ POSITION LAMP	12V 21W / 5W
WORK LAMP(REAR)	12V 25W

► CHECKING AND ADJUSTING BRAKE PEDAL

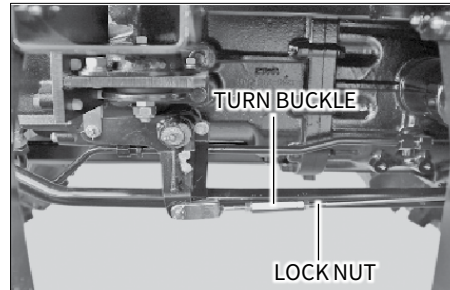

The brake pedal's play increases as it is used for an extended period of time. If its play is excessive, adjust it.

<adjustment>

1. Unscrew the lock nut and turn the adjusting nut to adjust the play (left and right).
2. Turning it counterclockwise increases the play while turning it clockwise decreases the play.
3. After adjustment, tighten the lock nut firmly.

► ADJUSTING CLUTCH PEDAL INCHING CABLE

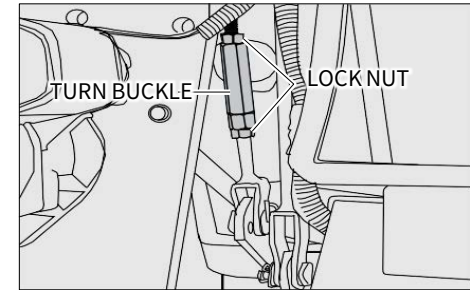

After prolonged use of the clutch pedal, play of its inching cable can become excessive.

<adjustment>

1. Open the side cover (left).
2. Loosen the lock nut and turn the turnbuckle to adjust the free play to the proper level.
3. After adjustment, make sure to tighten the lock nut firmly.
4. Close the side cover.

E

► **PROPER FREE PLAY OF CLUTCH/BRAKE PEDAL**

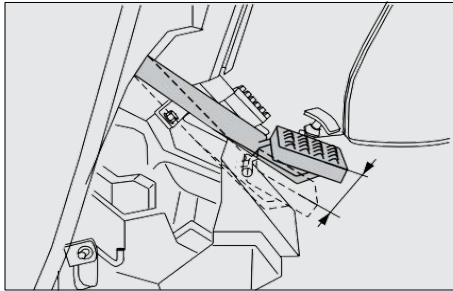

Press the pedal with a hand gently to check its play.

clutch pedal	brake pedal
0.79 ~ 1.18 in. (20 ~ 30mm)	1.18 ~ 1.57 in. (30 ~ 40 mm)

⚠ WARNING

- If the left and right brakes are not operated simultaneously, braking force is applied only to one side, leading to a dangerous situation. Make sure to adjust the left and right pedal's play to the same level.
- After adjustment, confirm the operating state.

► **CHECKING AND ADJUSTING FAN BELT**

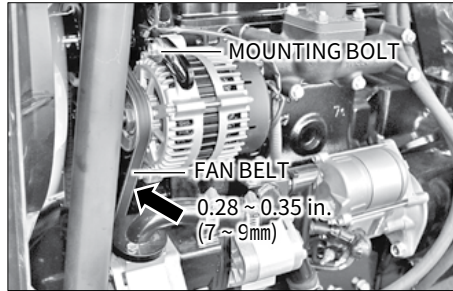

Check and adjust the fan belt's tension periodically.

1. Unscrew the alternator mounting bolt slightly and move the alternator to adjust the tension.
2. Check the belt's tension. Press the middle of the belt with about 13.23 ~ 15.43 lbs. (6 ~ 7 kg) of force. It is okay when the belt is deflected about 0.28 ~ 0.35 inch. (7 ~ 9mm)
3. Replace the belt if it is crocked or frayed, tegument is worn out or some pieces are detached.

► **FUEL HOSE CHECKING**

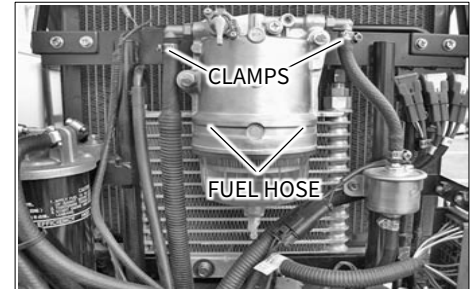

Check the fuel hose as follows :

1. Stop the engine. After the engine is sufficiently cooled down, open the hood.
2. Check if the fuel hose is damaged or leaks. Replace it if necessary.
3. Tighten the clamp.

▶ **AIR CLEANER HOSE CHECKING**



Check the air cleaner hose as follows :

1. Stop the engine. After the engine is sufficiently cooled down, open the hood.
2. Check if the air cleaner hose is damaged or leaks.
3. Replace it if necessary.
4. Tighten the clamp.

▶ **RADIATOR HOSE CHECKING**

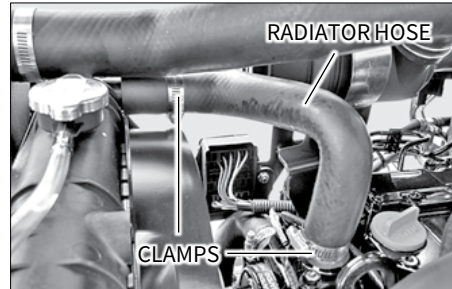

Check the radiator hose as follows :

1. Stop the engine. After the engine is sufficiently cooled down, open the hood.
2. Check if the radiator hose is damaged or leaks. Replace it if necessary.
3. Tighten the clamp.

▶ **TIRE INFLATION PRESSURE**

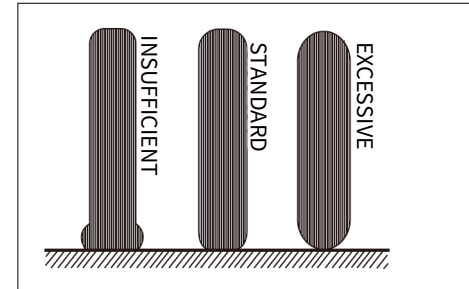

Check if the inflation pressure of the front and rear tires is correct.

If not, adjust it to the specification.

 **WARNING**

- Make sure to keep the specified inflation pressure of the tires to avoid an accident or even death due to tire's rupture.

E

▶ ADJUSTING WHEEL TREAD

It can be adjusted by switching the rims and discs of left and right tires.

⚠ WARNING

- For safety, have tread adjustment performed by your dealer or workshop.
- Never remove tires if there is no safe supporting device. The tractor can roll over.

⚠ WARNING

- After adjusting the wheel tread, the vehicle's breadth and turning radius are changed. Keep this in mind during driving.

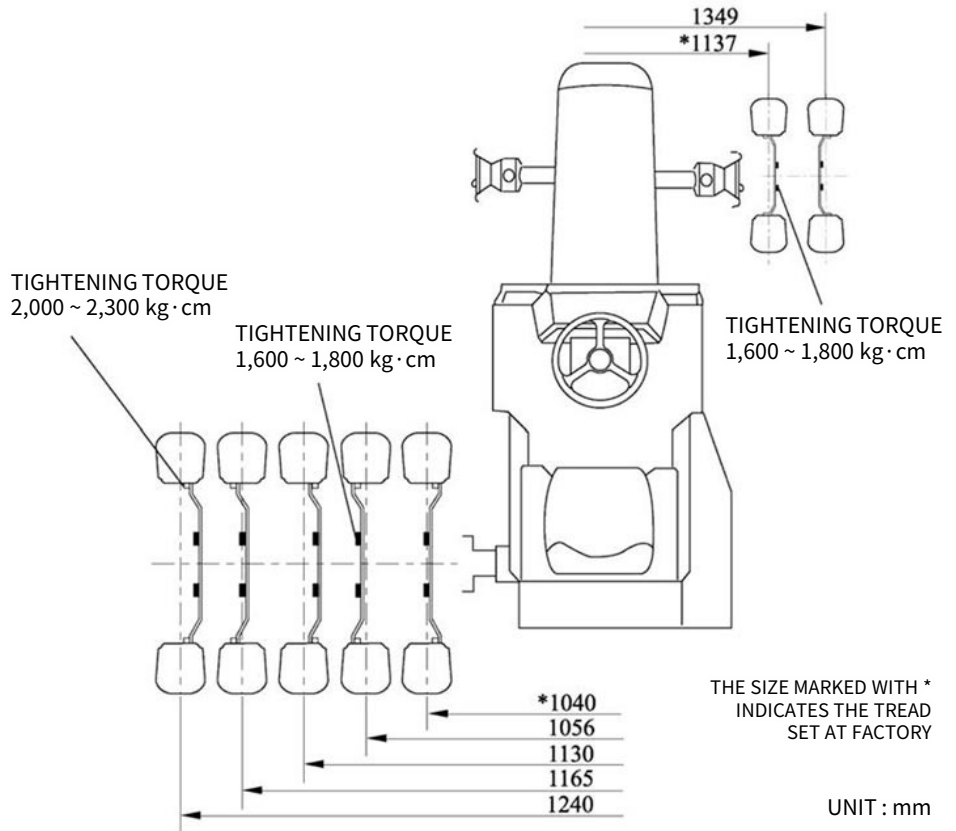

4. GREASING EACH PART

► GREASING AND DRAIN POINTS

For general greasing points, refer to the fuel, oil and fluid specification chart. However, add grease before work if the tractor is to be used in a wet field.

► GREASING BRAKE ARM

Remove the rubber caps on the floor and dash panel to access to the grease nipple.

Add grease with a grease gun.

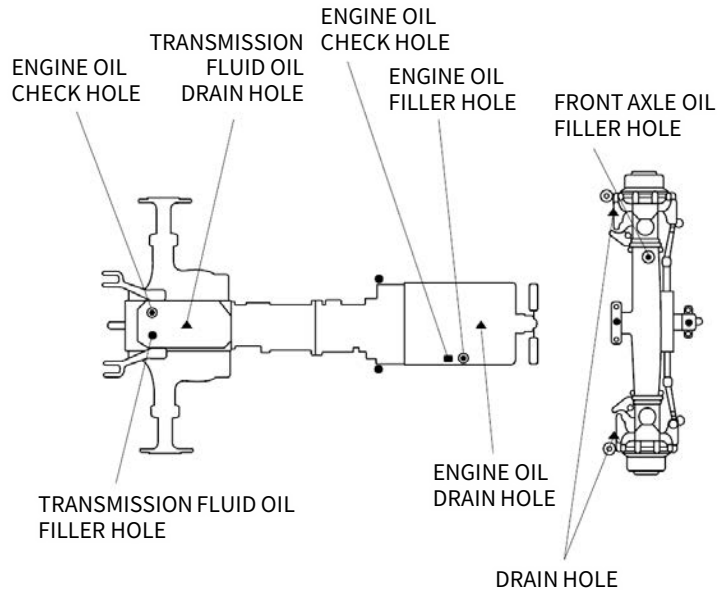

● FILLER HOLE ● GREASE NIPPLE ▲ DRAIN HOLE ■ CHECK HOLE

E



5. STORING THE TRACTOR

► DAILY STORAGE

1. Store the tractor after cleaning it. Especially, clean it thoroughly after harrowing or working in a wet field.
2. Make sure to lower an implement.
3. Store the tractor indoors if possible.
4. If storing the tractor outside, cover it.
5. For better start-ability, it is recommended to remove the battery from the tractor and keep it indoors in winter.
6. If the outside temperature is below 0°C, add antifreeze or drain coolant completely to prevent the engine from freezing and bursting.
7. Remove the key and store it separately.

► LONG-TERM STORAGE

Clean the tractor thoroughly and store it as follows:

1. Change engine oil with new oil and run the engine for 5 minutes to distribute oil to each part evenly.
2. Drain coolant from the radiator. Then, make a label indicating "No Coolant" and fix it onto the steering wheel. If antifreeze is already added, it is not necessary to drain coolant.
3. Add oil, fluid and fuel to each part according to the maintenance chart.
4. Apply a thin film of grease or oil to body parts that are apt to rust.
5. Check each bolt and nut for looseness and tighten any loose bolt and nut.
6. Set the tire inflation pressure a little higher than the specification.
7. Remove a weight. Detach or lower an implement.
8. Chock the rear wheels.
9. Remove the battery from the tractor or turn off its switch to cut power connection.
10. Use the clutch cut-off arm to disengage the clutch. If storing the tractor with the clutch engaged for an extended period of time, the clutch disc is oxidized, resulting in its seizure.
11. Place wood blocks under the tires to protect them.
12. Charge the battery every 2 months during long-term storage.
13. Store it in a dry place to avoid rain or snow and cover the body.

► **USE AFTER LONG-TERM STORAGE**

Keep the following instructions when using the tractor after its long-term storage.

1. Inspect the tractor thoroughly before driving it.
2. To keep performance and life of the engine, idle the engine for approx. 30 minutes after starting it.

 **CAUTION**

- If leaving the battery connected to the tractor, turn off its switch to cut electric power.
- If wiring is damaged by rodents, its short circuit can start a fire.

 **IMPORTANT**

- For engine lubrication, run the engine at 1,500 ~ 2,000 RPM for 5 to 10 minutes once a month.
- Remove the key from the tractor and store it separately.

► **USAGE AND DISPOSAL**

It is recommended to keep the followings to protect the environment:

1. Avoid overloading work as it can lead to incomplete combustion and emissions that can pollute the air.
2. When changing oil, including engine oil, transmission fluid, hydraulic oil and coolant, be careful not to spill it and discard used oil according to the applicable law. Used oil should be treated with care and discarded properly as it can contaminate soil and water.
3. When this or other machine's life is expired, do not neglect or discard it on your own, but contact your dealer so that the approved service provider can discard the machine according to the laws.



F. TROUBLESHOOTING

1. ENGINE TROUBLESHOOTING F – 2
2. CLUTCH TROUBLESHOOTING F – 5
3. BRAKE TROUBLESHOOTING F – 5
4. STEERING WHEEL TROUBLESHOOTING F – 6
5. HYDRAULIC SYSTEM TROUBLESHOOTING · F – 6
6. ELECTRIC INSTRUMENTS
TROUBLESHOOTING F – 7
7. AIR CONDITIONER TROUBLESHOOTING F – 8

1. ENGINE TROUBLESHOOTING

	ISSUE	CAUSE	ACTION
	The start motor does not rotate when the key switch is turned	<ul style="list-style-type: none"> Clutch pedal released PTO switch is on 「ON」 position Defective safety switch Battery discharged Loose terminal Faulty switch Defective start motor 	<ul style="list-style-type: none"> Depress the clutch pedal Set PTO switch into 「OFF」 position Have it repaired or replaced by workshop Charge battery Check for looseness and corrosion Clean, tighten and apply grease Have it repaired or replaced by workshop Have it repaired or replaced by workshop
	The start motor runs, but its speed cannot be increased	<ul style="list-style-type: none"> Weak battery Poor ground Incorrect viscosity of engine oil 	<ul style="list-style-type: none"> Charge battery. Clean contact and connect ground firmly Change engine oil with proper viscosity
ENGINE	The start motor runs, but engine cannot be started	<ul style="list-style-type: none"> Air in fuel system Clogged fuel filter No fuel supply Defective engine Defective key stop unit 	<ul style="list-style-type: none"> Bleed the system Clean or replace the filter Open the cock and add fuel Have it repaired or replaced by workshop Have it repaired or replaced by workshop
	Engine runs irregularly	<ul style="list-style-type: none"> Air in fuel system Clogged fuel filter Clogged injection nozzle Fuel leak from pipe Poor fuel injection quality 	<ul style="list-style-type: none"> Bleed the system Clean or replace the filter Have it repaired or replaced by workshop Tighten clamp, replace pipe or machine surface of copper washer before installation Have it repaired or replaced by workshop
	Engine stops at low speed	<ul style="list-style-type: none"> Defective injection pump Incorrect clearance of engine valve Low idle speed Faulty nozzle 	<ul style="list-style-type: none"> Have it repaired or replaced by workshop Have it repaired or replaced by workshop Adjust speed to the rated speed Have it repaired or replaced by workshop

	ISSUE	CAUSE	ACTION
E N G I N E	The engine overruns	<ul style="list-style-type: none"> • Restricted governor • Oil increased 	<ul style="list-style-type: none"> • Have it repaired or replaced by workshop • Have it repaired or replaced by workshop
	The engine stalls suddenly	<ul style="list-style-type: none"> • Low fuel level • Faulty nozzle • Engine seizure by insufficient oil or poor lubrication 	<ul style="list-style-type: none"> • Add more fuel and bleed the system • Have it repaired or replaced by workshop • Have it repaired by workshop
	The engine is overheated	<ul style="list-style-type: none"> • Insufficient coolant amount • Loose or damaged fan belt • Clogged radiator • Insufficient engine oil 	<ul style="list-style-type: none"> • Add coolant • Adjust fan belt tension or replace it • Clean radiator • Inspect and replenish
	The engine produces white or black smoke	<p>White smoke</p> <ul style="list-style-type: none"> • Clogged air cleaner • Excessive engine oil amount • Insufficient fuel delivery amount <p>Black smoke</p> <ul style="list-style-type: none"> • Low quality fuel • Excessive fuel amount delivery • Insufficient nozzle pressure 	<p>White smoke</p> <ul style="list-style-type: none"> • Clean air cleaner element • Check and set the proper amount • Have it repaired or replaced by workshop <p>Black smoke</p> <ul style="list-style-type: none"> • Add specified fuel • Have it repaired or replaced by workshop • Have it repaired or replaced by workshop

	ISSUE	CAUSE	ACTION
E N G I N E	The engine power is insufficient	<ul style="list-style-type: none"> • Clogged or carbon on nozzle tip • Insufficient compression or gas leak from valve seat • Incorrectly adjusted valve clearance • Incorrect injection timing • Insufficient fuel • Clogged air cleaner • Urea supply shortage 	<ul style="list-style-type: none"> • Have it repaired or replaced by workshop • Have it repaired or replaced by workshop • Have it repaired or replaced by workshop • Have it repaired or replaced by workshop • Add more fuel • Clean the air cleaner element • Add more urea
	The oil warning lamp comes on during driving	<ul style="list-style-type: none"> • Low engine oil level • Low viscosity of engine oil • Faulty pressure switch • Defective oil pump • Oil filter element clogged 	<ul style="list-style-type: none"> • Add engine oil to specified level • Change oil with proper viscosity • Replace the switch • Have it repaired by workshop • Replace the element
	The charge warning lamp comes on during driving	<ul style="list-style-type: none"> • Defective wiring • Defective alternator • Defective battery or insufficient distilled water • Loose or damaged fan belt 	<ul style="list-style-type: none"> • Check for loose or missing terminal, short circuit and poor ground and repair as necessary • Have it repaired by workshop • Replace the battery or add distilled water • Adjust the tension or replace the belt

2. CLUTCH TROUBLESHOOTING

	ISSUE	CAUSE	ACTION
C L U T C H	The clutch slips	<ul style="list-style-type: none"> • Incorrectly adjusted pedal 	<ul style="list-style-type: none"> • Adjust the pedal play
	The clutch cannot be disengaged	<ul style="list-style-type: none"> • Incorrectly adjusted pedal 	<ul style="list-style-type: none"> • Adjust the pedal play

3. BRAKE TROUBLESHOOTING

	ISSUE	CAUSE	ACTION
B R A K E	The brake won't operate. Also, only one-side brake operates	<ul style="list-style-type: none"> • Excessive brake pedal play • Worn or burnt liner • Different play amount on left and 	<ul style="list-style-type: none"> • Adjust the play • Have it repaired by workshop • Set the left and right play amount the same
	The clutch pedal does not return to its original position properly	<ul style="list-style-type: none"> • Damaged brake return spring • No grease on each sliding section 	<ul style="list-style-type: none"> • Replace the spring • Remove rust and apply grease

4. STEERING WHEEL TROUBLESHOOTING

	ISSUE	CAUSE	ACTION
S T E E R I N G	The steering wheel feels heavy or The steering wheel vibrates	<ul style="list-style-type: none"> • Improper toe-in • Incorrect tire inflation pressure • Vibration from each connection 	<ul style="list-style-type: none"> • Adjust toe-in • Set left and right tires to same specified pressure • Tighten or replace connection
	The free movement of steering wheel is excessive	<ul style="list-style-type: none"> • Worn steering wheel shaft • Worn metal parts • Free play from each connection 	<ul style="list-style-type: none"> • Have it repaired by workshop • Have it repaired by workshop • Tighten free play of each connection

5. HYDRAULIC SYSTEM TROUBLESHOOTING

	ISSUE	CAUSE	ACTION
H Y D R A U L I C	Oil leaks from the pipe or hose	<ul style="list-style-type: none"> • Loose clamps • Cracked pipes 	<ul style="list-style-type: none"> • Tighten clamps • Have it replaced by workshop
	Hydraulic pressure won't be decreased	<ul style="list-style-type: none"> • Lowering speed control lever fixed • Defective valve • Damaged cylinder • Damaged and seized lift shaft rotating part 	<ul style="list-style-type: none"> • Set it to the lowering position • Have it repaired by workshop • Have it repaired by workshop • Have it repaired by workshop
S Y S T E M	The hydraulic pressure won't be increased	<ul style="list-style-type: none"> • Insufficient engine RPM • Insufficient transmission fluid • Air sucked into suction pipe • Clogged oil filter • Defective hydraulic pump • Defective valve • Damaged cylinder 	<ul style="list-style-type: none"> • Set the speed to 1,000 to 1,500 RPM • Add to the specified level • Tighten the connection. • If any pipe or hose is cracked or O-ring is damaged, replace them. • Have it repaired by workshop • Have it repaired by workshop • Have it repaired by workshop

6. ELECTRIC SYSTEM TROUBLESHOOTING

	ISSUE	CAUSE	ACTION
E L E C T R I C S Y S T E M	The battery won't be charged	<ul style="list-style-type: none"> • Blown fusible link • Defective wiring • Defective alternator • Loose or damaged fan belt • Defective battery function 	<ul style="list-style-type: none"> • Check the wiring and replace the fusible link • Check for loose or missing terminal, short circuit and poor ground and repair as necessary • Have it repaired by workshop • Adjust the tension or replace the belt • Check for loose or corroded terminal and insufficient electrolyte and take any necessary action
	The headlamp does not produce enough light	<ul style="list-style-type: none"> • Low charging level of battery • Contact failure in wiring 	<ul style="list-style-type: none"> • Charge • Check, clean and re-tighten the ground and terminal
	The headlamp does not come on	<ul style="list-style-type: none"> • Blown bulb • Blown fuse • Contact failure 	<ul style="list-style-type: none"> • Replace the bulb • Check the wiring and replace the fuse • Check and clean the ground and terminal
	The horn does not operate	<ul style="list-style-type: none"> • Defective horn switch • Defective wiring • Damaged horn 	<ul style="list-style-type: none"> • Replace • Repair • Repair or replace
	The turn signal lamp does not blink	<ul style="list-style-type: none"> • Blown bulb • Defective flasher unit • Poor contact 	<ul style="list-style-type: none"> • Replace the bulb • Replace • Check and clean the ground and terminal
	The work lamp does not come on	<ul style="list-style-type: none"> • Blown bulb • Contact failure 	<ul style="list-style-type: none"> • Replace the bulb • Check and clean the ground and terminal

F

7. AIR CONDITIONER TROUBLESHOOTING

	SYMPTOM	CONDITION	CAUSE	ACTION
C O M P R E S S O R	Abnormal sound	<ul style="list-style-type: none"> Inlet / Outlet sound 	<ul style="list-style-type: none"> Insufficient lubrication Belt tension release Release the bracket 	<ul style="list-style-type: none"> Replenish Adjust Tighten the bolts
	Abnormal revolution	<ul style="list-style-type: none"> Inlet cause Outlet cause 	<ul style="list-style-type: none"> Damaged parts Insufficient lubrication Belt tension released 	<ul style="list-style-type: none"> Check, replace Replenish Adjust
	Refrigerant or oil leakage	<ul style="list-style-type: none"> Refrigerant or oil leakage 	<ul style="list-style-type: none"> Sealing washer damaged Head bolt released D-ring damaged 	<ul style="list-style-type: none"> Replace Tighten the bolts Replace
	Excessive pressure	<ul style="list-style-type: none"> Low, high pressure 	<ul style="list-style-type: none"> Insufficient refrigerant Compressor 	<ul style="list-style-type: none"> Adjust Replace
M O T O R	Weak from pressure or don't work	<ul style="list-style-type: none"> Motor is normal Motor is abnormal Air leakage 	<ul style="list-style-type: none"> Air inlet clogged Evaporator freezing Ventilator switch damaged Compressor Motor failure Wire cut Duct leakage 	<ul style="list-style-type: none"> Remove Controlling minimum pressure Replace the switch Replace Replace Replace Check, tighten
	Unable to control the fan	<ul style="list-style-type: none"> Motor 	<ul style="list-style-type: none"> Air volume control switch failure Motor failure 	<ul style="list-style-type: none"> Check, tighten Replace
	Noise	<ul style="list-style-type: none"> Regular or irregular noise 	<ul style="list-style-type: none"> Interference with pulley 	<ul style="list-style-type: none"> Control compressor direction
C L U T C H	Disengage	<ul style="list-style-type: none"> Engaged sometimes Engaged to push with hand No defect wire 	<ul style="list-style-type: none"> Wire defect Clutch gap large Low voltage Malfunction 	<ul style="list-style-type: none"> Check wire Adjust Check battery Replace
	Slip	<ul style="list-style-type: none"> Slip during rotation 	<ul style="list-style-type: none"> Low voltage Oil stick at clutch Malfunction 	<ul style="list-style-type: none"> Check battery Clean Replace



G. STANDARD FOR FARMWORK

TO ENSURE SAFE AGRICULTURAL WORK, SAFETY PRECAUTIONS FOR USE OF AGRICULTURAL MACHINERY ARE SET BY THE NATIONAL INSTITUTE OF AGRICULTURAL ENGINEERING.

READ THIS INFORMATION THOROUGHLY ALONG WITH THE USER MANUAL TO ENSURE SAFE WORK.



1. STANDARD FOR FARMWORK

▶ SAFETY MARK

Always make sure to check the operating condition of the safety lamp (such as turn signal lamp) before operating the machine.

※ If any lighting system is removed※ It may lead to an unexpected accident because it is not possible to give signals to people or machine nearby.

▶ INSTRUCTION BEFORE USE

Operator must attend his/her health and should get enough rest.

Before using the machine, check it and repair if there is a malfunction.

- Check if the assembly of front and rear wheels is okay.
- Check the tightening of bolts and nuts in each unit.

Do not drive if you are mentally unstable, drunk, pregnant, under the age of 16, not trained, overworked, sick, under the influence of drugs, and any other reason that may affect normal operation of the machine.

Please wear the appropriate working clothing.

- Put on a hard hat to protect your head.
- Put on a hat and a working clothes, to prevent an injury such as being twined into the machine.

- Protective measures to prevent any injury on foot or slipping - Put on an appropriate non-slippery shoes to prevent a fall from the machine, scattering soil, and slippery surface.
- Measures against dust and toxic gas.
- Wear an appropriate protective gear.
- Measures against the herbicide : wear protective gear to protect respiratory system, eyes and skin.
- Measures against noise : wear a protective gear to protect your ears.
- Handling protective gear : do neither let children get on the machine nor get close to the machine.

If it is not possible to park the agricultural machine on a road either due to a breakdown or any other reason, operator must take an action such as moving the equipment to a place other than a road.

Also, put a signal that there is a broken car, 100m behind and 200m at night in accordance with Automobile Regulation Article 23.

When starting to drive, make sure to check around carefully.

- Do not let anyone such as a child get close to the machine, keep them away and then drive the machine.

Do not load flammable, explosive material (diesel, gasoline , etc) on the machine.

When getting on and off a truck, have a helper give you signal and follow his/her lead.

Refer to chapter A in user's manual regarding the decals on the machine.

▶ CHECKUP LIST FOR OPERATION

Before using the machine, check it and repair if there is a malfunction.

Check engine oil.

- Pull out level gauge, wipe off any fuel leak, put it back in, and pull it out again to see if the oil level is between 「upper limit」 and 「lower limit」 .

Before any operation, check for any foreign materials caught on the engine, muffler, battery, and the fuel tank. Remove them immediately.

Covers that are removed during the maintenance work should be reinstalled to their original positions.

- Attach the cover correctly and firmly.

▶ CAUTIONS DURING THE WORK

Do not load anything that can interfere driving.

- Always keep the driver's seat clean.

Always buckle up when driving.

Opening radiator cap when heated can spring out the steam to have the operator burned.

Open the cap after it is sufficiently cooled down.

Do not drive with depressing the differential gear pedal.

Prohibit anyone to get on the machine.

- Prohibit anyone to get on the machine other than the designated place.
- Even though there are some designated place, do not let people more than capacity get on the machine.



- Never let any passenger mount on the machine.
Also, do not put any object on the machine.
Keep people away from the machine.
- Do not jump on/off the operating machine except for emergency.

Be cautious not to let anyone touch the belt .

Always check the connected area of belt. When two people are working collaboratively, exchange signals each other.

Prevent injury.

- Do not touch power transmission gear, rotating unit, and other dangerous parts.
- Pay special attention if you are working with the machine with blade or sharp projection.
- Be careful not to injure from the work where soils and stones are scattered around.

Safety in inspection, adjustment, etc.

- Make sure to stop the motor and carry out the work in a safe environment.
- When leaving the machine for a break, or other reason, leave the machine in a safe place and descend the working unit to keep them in a safe stopped state.

Removing and installing should be carried out in a safe place and with a safe method.

Do neither stay nor insert foot under the working units.

► CAUTIONS WHEN DRIVING ON FARM ROAD

Driving on roads

- Drive safely observing the relevant regulation.
- Drive at safe speed.
- Be careful not to disturb other drivers.
- When driving a machine with sharp blade or bump, put on a warning sign or detach in advance to prevent any injury.
- Do not drive fast particularly on winding roads with projecting rocks.
- When driving at night, do not detach lighting device. (headlight, turn indicator, work light, brake light, etc.)
- Do not drive fast, abrupt starting, abrupt acceleration, sudden stop, and quick turning.
- When driving at high speed, do not slam on the brake. Never slam on the brake especially when turning at high speed.

When loading/unloading the machine

- Choose a place with a leveled and safe ground.
- Drive at low speed.
- Use a ramp with anti-slippery.

When entering paved road

- Use a ramp to cross a ditch or a bank.
- Make sure to use a ramp to enter/exit a high footpath. Be careful with fall and not to overturn.
- Check the safety around the surrounding before starting to drive.

When driving on a slope

- Drive at the minimum speed, lower the operating machine as low as possible and low the center position.

► INSTRUCTION AFTER USE

When the work is completed, stop the engine on a leveled ground, check the machine to clean. (remove any foreign materials)

- Remove straws, dirt, etc. and clean around the engine, silencer, and fuel tank.

Lay a cover on the transplanter (equipment) after the muffler and engine cool down.

Get a regular inspection after the season is over.

- When discarding a part (battery, oil, etc.) or scrap a machine, consult to a dealer and proceed accordingly.

For long-term storage, remove the battery from the machine and store it or disconnect the negative battery cable.

► CAUTIONS FOR INSPECTION & MAINTENANCE

Do not refuel either when the engine is still hot or while driving.

Measures against a fire: Every working place with a risk of fire should be provided with a fire extinguisher. Prevent a fire by taking measures such as making a smoking area.

Always wipe off the leaked fuel.

Be seated in the cab when starting the engine.

After refueling, tighten the fuel cap and check if there is any fuel leakage from tank or pipe.

When opening a cap to supply water to radiator, be careful because steam or boiling water may spray due to overheating.



When getting off the cab, turn off the engine, lock the parking brake and remove the ignition key.

If it is inevitable to park on a slope, choke the wheels.

Park on a leveled and safe ground safely.

Check if the wiring code is in contact with other parts, peeled, loose or having spacing.

Manage PTO

- Stop PTO before stopping the engine.
- Do not remove the PTO protective cover or protective panel for operating machine.
- Do not use PTO adaptor in order to extend the PTO coupler or universal joint to outside of PTO protective cover.

To repair, secure the wheel width, or changing the wheel under either tractor or trailer, with the tractor or trailer raised, choke the wheels that are on the ground.

Do not use hydraulic jack for operating machine or tractor. Instead, use block or stand.

Safety frame

- Do neither weld nor drill a hole on the attached safety frame. Also do not modify it.
- Replace the damaged safety frame with a new one.

- If the safety frame was removed for specialized work, restore it immediately.

Be careful to touch dangerous area such as power transmission gear, rotating unit, etc. Put on a protective cover.

Do neither modify nor remove the safety device.

When checking and replacing the blade to plow the ground

- Stop the engine.
- Prevent the rotary from falling by turning the fall adjusting handle to stop hydraulic pressure.
- Apply the parking brake.
- Do not stand between tractor and rotary.

When working with rotary

- Do not put your hands near the rotating part such as blade axle and universal joint.

- Do not ride on the rotary.
- When driving backward or turning quickly with the rotary raised up, make sure to check behind the machine.
- Adjust the rear cover.

► OTHER PRECAUTIONS

The following items can affect the tractor performance and safety.

Therefore, Repair of these items should be done by your workshop.

- Injection pump, nozzle, engine valve clearance, hydraulic valve, hydraulic pump and evaporator.



H. APPENDIX

1. SPECIFICATIONS H – 2
2. MAJOR CONSUMABLES H – 6
3. NOISE LEVELS H – 7
4. VIBRATION REFERRED TO THE OPERATOR
POSITION H – 8

1. SPECIFICATIONS

ITEM		T355NC, T355ST	T395NC, T395ST	
ENGINE	MANUFACTURE		YANMAR	
	MODEL		3TNV88C-K	3TNV88C-D
	TYPE		4 cycle, Inline, Water-cooled Diesel	
	gross	kW[HP]	25.5 [34.2]	27.5 [36.9]
	RATED ENGINE SPEED	RPM	2,800	3,000
	Number of cylinders		3	
	Displacement	cu.in[cc]	100.2 [1642]	
	Air Cleaner		Dual Dry	
	Alternator		12V 55A	
	Fuel system type		CRDI	
POWER TRAIN	Transmission type		Synchromesh + Constant mesh	
	Number of speed		F12, R12	
	Max traveling speed	mph [km/h]	14 [22.6]	15 [24.2]
	Brake		Wet Disc	
	Steering		Hydrostatic	
PTO	PTO Type		Independent	
	PTO Control		Electric/Hydro	
	PTO Rear	rpm	540	
	PTO Shaft diameter	in[mm]	1 $\frac{3}{8}$ [35]	

ITEM		T355NC, T355ST	T395NC, T395ST	
HYDRAULIC SYSTEM	Pump type		DUAL GEAR PUMP	
	Implement pump capa.	gpm (ℓ/min)	6.3 [23.9]	
	Steering pump capa.	gpm (ℓ/min)	4.6 [17.3]	
	Max. Total flow	gpm (ℓ/min)	10.9 [41.2]	
	TPL Category		1	
	Hitch lift capa. (at 24 in. behind link end)	lbs. (kg)	2,646 [1,200]	
			1,764 [800]	
	Lift control type		Draft/Position	Position
	Joystick valve		STANDARD	
	Number of remote valve		2	
DIMENSION	Overall length with 3P	in[mm]	126 [3.200]	128 [3,250]
	Overall width	in[mm]	53.5 [1.360]	58.0 [1,475]
	Wheelbase	in[mm]	64.6 [1.640]	66.9 [1,700]
	Height to top of ROPS	in[mm]	94.4 [2.400]	92.5 [2,350]
	Min. Ground Clearance	in[mm]	12.8 [325]	
	Min. Turn Radius, with Brakes	in[mm]	94.4 [2,400]	116 [2,950]

H

ITEM			T355NC,T355ST	T395NC, T395ST
Capacities	Fuel tank	U.S.gal.[L]	9.0 [34]	
	Cooling system	U.S.gal.[L]	7.4 [7]	
	Crankcase(with filter)	U.S.gal.[L]	6.0 [5.7]	
	Trans&Hydr.System	U.S.gal.[L]	9.25 [35]	
	Front Axle	U.S.gal.[L]	8.7 [8.2]	
Standard Tires	Agricultural Tire Front		8.0-16, 4PR	
	Agricultural Tire Rear		12.4-24, 6PR	
	Industrial Tire Front		27x10.50-15, 8PR	
	Industrial Tire Rear		12.5-20, 10PR	
	Turf Tire Front		27x10.50-15, 4PR	
	Turf Tire Rear		41x14.00-20, 4PR	
ROPS	Roll Over Protection Standard		Rear Roll-bar	Cabin
	Total Weight	lbs[kg]	3,128 [1,419]	3,472 [1,575]

▶ TRAVELLING SPEED

Km/h

SHIFT		TRAVELING SPEED			
		T355		T395	
SUB SHIFT	MAIN SHIFT	FORWARD	REVERSE	FORWARD	REVERSE
L	1	0.92	0.84	0.99	0.90
	2	1.26	1.16	1.35	1.24
	3	1.62	1.49	1.74	1.59
	4	2.24	2.05	2.40	2.20
M	1	2.91	2.66	3.11	2.85
	2	3.99	3.66	4.27	3.92
	3	5.13	4.70	5.50	5.03
	4	7.08	6.49	7.59	6.95
H	1	9.28	8.50	9.95	9.11
	2	12.74	11.68	13.65	12.51
	3	16.38	15.01	17.55	16.08
	4	22.62	20.73	24.24	22.22

※ The specifications are subject to change for improvement without notice.

H

2. MAJOR CONSUMABLES

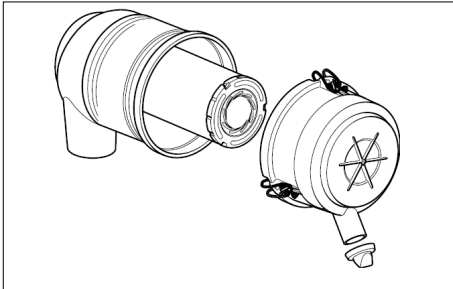

ELEMENT SET

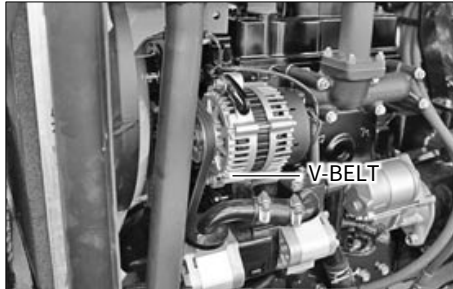

V-BELT

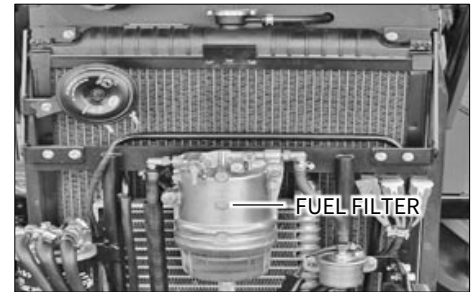

FUEL FILTER



ENGINE OIL FILTER

NO	ITEM	QUANTITY	APPLICATION
1	ELEMENT SET	1	AIR CLEANER
2	V-BELT	1	ENGINE FAN BELT
3	FUEL FILTER	1	FUEL FILTER
4	ENGINE OIL FILTER	1	ENGINE OIL FILTER

3. NOISE LEVELS

The tractor is approved in accordance with the applicable EC Directives.

To avoid increased noise levels proceed as follows:

- After maintenance operations or repairs refit all the sound-deadening panels and materials correctly
- Do not make changes to the tractor that may lead to an increase in noise emissions.
- Beware of any anomalous noise or vibration if you notice anomalous noise or vibration, park the tractor in a safe position and perform the stopping procedure.
Inform maintenance personnel of the situation.
Avoid prolonged operation.

Reference standards for the measurement of noise levels:

- The maximum driver-perceived noise level, with the engine at normal operating temperature and measured in accordance with the test method described in the European Directive 2009/76EC

MODEL	NOISE LEVELS	
	Driver-perceived sound level [dB(A)]	
	Cab(openings closed)	Roll bar
T355 / 395NC		85
T355 / 395ST	83.5	

- The maximum noise level measured with the tractor in motion and the tractor stationary, measured in accordance with the method described in European directive 2009/63/EC.

MODEL	NOISE LEVELS			
	Maximum external noise level With tractor moving, db(A)		Maximum external noise level With tractor stationary, db(A)	
	Cab	Roll bar	Cab	Roll bar
T355 / 395NC	-	77.5	-	75
T355 / 395ST	77.5	-	75	-

4. VIBRATION REFERRED TO THE OPERATOR POSITION

The value is referred to the amount of mechanical vibration transmitted by the tractor to WHOLEBODY as defined by UNI ISO2631-1:2008.

Said value must be utilized for assessment of the vibration exposure risk, but it cannot cover all the possible conditions of use of the tractor since it may vary in accordance with parameters that are not always related to the tractor (terrain, implements, etc.) If the risk assessment cannot be considered to be exhaustive or if the risk may exceed the values defined in 2002/44/EC, the use of a vibration meter prescribed.

In order to minimize the vibration transmitted to the whole-body the following best practice rules should be observed:

- Use the most suitable implement for the tractor and the task in hand
- Adjust the seat to suit your weight and stature
- Periodically check the condition of the cab suspensions and renew them if damaged
- Check tire inflation pressure
- Use front axle suspensions, if fitted
- During transfers, adjust tractor speed in order to minimize the vibration level.

The seat vibration values, as obtained from the seat approval in compliance with 78/764/EEC (amended by 1999/57/EC) are shown in the following table.

Technical data:

Input vibration : Category A, Class I ,II and III

Ambient temperature : 23°C

SEAT	DRIVER TYPE	CORRECTED VIBRATION LEVEL ON SEAT
W09SSS	LIGHT DRIVER (59kg)	1.241m/sec ²
	HEAVY DRIVER (98kg)	1.222m/sec ²



I. INDEX

1. INDEX | - 2

• 0~9

4WD LEVER C-18

• A

ABNORMAL OPERATION DURING DPF REGENERATION

PROCESS D-10

ABOUT THIS MANUAL A-10

ADJUSTING CLUTCH PEDAL INCHING CABLE E-17

ADJUSTING WHEEL TREAD E-20

AIR CLEANER CLEANING AND REPLACING E-13

AIR CLEANER FILTER CONTAMINATED LAMP C-11

AIR CLEANER HOSE CHECKING E-19

AIR CLEANING SYSTEM D-23

AIR CONDITIONER CONTROL C-35

AIR CONDITIONER TROUBLESHOOTING F-8

ALWAYS USE SAFETY LIGHTS AND DEVICES B-5

APPENDIX H-1

AVOID HIGH PRESSURE FLUIDS B-6

• B

BACK SIDE OF THE TRACTOR (CABIN) A-8

BATTERY CHARGING D-15, E-14

BATTERY DISCONNECTING E-15

BATTERY DISCONNECTION B-8

BATTERY JUMP START E-14

BLEEDING FUEL SYSTEM E-12

BRAKE D-24

BRAKE PEDALS C-14

BRAKE TROUBLESHOOTING F-5

• C

CAB CEILING C-32

CABIN C-29

CABIN AIR INTAKE FILTER C-38

CABIN TYPE A-15

CAUTIONS DURING THE WORK G-3

CAUTIONS FOR DRIVING INTO OR OUT OF FIELD D-6

CAUTIONS FOR DRIVING ON ROAD D-6

CAUTIONS FOR INSPECTION & MAINTENANCE G-5

CAUTIONS WHEN DRIVING ON FARM ROAD G-4

CHARGE WARNING LAMP C-10

CHECK DURING DRIVING D-15

CHECK LINK C-26

CHECKING AND ADJUSTING BRAKE PEDAL E-17

CHECKING AND ADJUSTING FAN BELT E-18

CHECKING AND CHANGING ENGINE OIL E-7

CHECKING AND CHANGING FRONT AXLE OIL E-9

CHECKING AND CHANGING TRANSMISSION FLUID E-8

CHECKING AND REPLACING FUSE E-16

CHECKING BATTERY E-13

CHECKING ELECTRIC WIRING E-15

CHECKING HOSES ······	E-13	DOOR ······	C-30
CHECKING THE AIR CONDITIONING SYSTEM ······	C-39	DOs & DON'Ts ······	B-22
CHECKING THE AIR CONDITIONING SYSTEM CHARGE ······	C-39	DOs –FOR BETTER PERFORMANCE ······	B-22
CHECKS & SERVICING EACH PART ······	E-5	DPF PROGRESS LAMP ······	C-11
CHECKS DURING DRIVING ······	D-15	DPF WARNING LAMP ······	C-12
CHECKUP LIST FOR OPERATION ······	G-3		
CIRCULATION AIR VENTS ······	C-38	• E	
CLEANING RADIATOR AND CONDENSER GRILLES ······	E-7	ELECTRIC INSTRUMENTS TROUBLESHOOTING ······	F-7
CLUTCH LEVER ······	C-15	EMERGENCY EXITS ······	B-9
CLUTCH TROUBLESHOOTING ······	F-5	ENGINE ······	D-23
COMBINATION SWITCH ······	C-4	ENGINE AND DPF MALFUNCTION ······	D-10
CONNECTION TO IMPLEMENTS ······	D-11	ENGINE COOLANT INSPECTION AND CHANGE ······	E-6
CONTROL INSTRUMENTS ······	C-13	ENGINE IDLING ······	D-3
COOLANT TEMPERATURE ······	D-16	ENGINE OIL PRESSURE WARNING LAMP ······	C-10
COOLANT TEMPERATURE GAUGE ······	C-8	ENGINE TROUBLESHOOTING ······	F-2
COOLING SYSTEM ······	D-26	ENGINE WARNING LAMP ······	C-12
CUP HOLDER, TRAY ······	C-39	EXTERIOR VIEW ······	A-2
CUSHION STRENGTH ADJUSTMENT ······	A-16		
DAILY STORAGE ······	E-22	• F	
DAMAGE OF ROPS ······	A-15	FALLING OBJECT PROTECTIVE STRUCTURE (FOPS) ······	B-13
		FIGURE OF CABIN ······	C-29
• D		FIGURE OF MONITOR PANEL ······	C-6
DESCRIPTION ······	A-12	FIGURE OF SWITCHES (CABIN) ······	C-3
DIFFERENTIAL LOCK PEDAL ······	C-17	FIGURE OF SWITCHES (ROPS) ······	C-2
DISCONNECTION FROM IMPLEMENTS ······	D-11	FIGURE OF THREE POINT LINKAGE (CABIN) ······	C-25
DON'Ts –FOR SAFE OPERATION ······	B-23	FIGURE OF THREE POINT LINKAGE (ROPS) ······	C-24

FIGURE OF TRACTOR CONTROLS	C-13	HOURMETER	C-7
FRONT LOADER	D-21	HOW TO CHECK THE AIR CONDITIONING SYSTEM WITH THE NEEDLE OF HIGH-LOW GAUGE	C-40
FRONT LOADER VALVE	C-21	HOW TO START ENGINE	D-2
FUEL FILTER CLEANING AND ELEMENT REPLACING	E-12	HOW TO USE OF JACKS	D-28
FUEL GAUGE	C-7, D-16	HYDRAULIC LOWERING SPEED CONTROL KNOB	C-19
FUEL HOSE CHECKING	E-18	HYDRAULIC SYSTEM TROUBLESHOOTING	F-6
FUEL TANK	E-11		
FUEL WARNING LAMP	C-9		
• G		• I	
GAGUE PRESSURE CONVERSION	C-40	IDLING IN COLD WEATHER	D-3
GENERAL IMPLEMENT	D-17	IMPLEMENT HITCHING AND UNHITCHING	C-27
GENERAL INFORMATION	A-1	IMPLEMENTS	D-11
GENERAL INFORMATION OF DECALS	B-24	INDEX	I-2
GLOW LAMP	C-9	INSIDE OF CABIN	C-33
GREASING AND DRAIN POINTS	E-21	INSPECTION ITEMS	E-5
GREASING BRAKE ARM	E-21	INSTRUCTION AFTER USE	G-5
GREASING EACH PART	E-21	INSTRUCTION BEFORE USE	G-2
		INTERIOR LAMP	C-35
		INTRODUCTION & DESCRIPTION	A-11
• H		• J	
HANDLE FUEL SAFELY TO AVOID FIRE	B-5	JOYSTICK LEVER	C-21
HAZARD WARNING SWITCH	C-5	JOYSTICK LEVER SAFETY DEVICE	C-21
HEADLIGHT LAMPS	C-8		
HEATING AIR CONDITIONER SYSTEM	C-37		
HEATING SYSTEM	C-36		
HEATING SYSTEM CONFIGURATION	C-37	• K	
		KEEP RIDERS OFF TRACTOR	B-4

KEY SWITCH C-4

• **L**

LAMPS RELATED TO DPF PROCESS BUZZING D-9
 LEFT SIDE OF THE TRACTOR (CABIN) A-7
 LEFT SIDE OF THE TRACTOR (FRONT ROPS) A-5
 LEFT SIDE OF THE TRACTOR (REAR ROPS) A-3
 LOADING TO OR UNLOADING FROM TRUCK D-6
 LONG-TERM STORAGE E-22
 LOWER LINK C-26
 LUBRICATING OIL D-24

• **M**

MAIN GEAR LEVER C-16
 MAINTENANCE E-1
 MAINTENANCE SCHEDULE E-2
 MAJOR CONSUMABLES H-6
 MAJOR FEATURES OF CABIN C-30
 MID PTO (OPTION) C-22
 MONITOR PANEL & GAUGES C-6
 MOUNTING AND DEMOUNTING IMPLEMENTS B-17
 MOUNTING IMPLEMENTS D-12

• **N**

NCD LAMP C-12
 NOISE LEVELS H-7

• **O**

OIL PRESSURE D-15
 OIL SYSTEM D-24
 OPENING COVERS E-4
 OPENING HOOD E-4
 OPERATING PTO D-7
 OPERATING TIPS FOR POWER STEERING WHEEL D-27
 OPERATING TRACTOR D-4
 OPERATION D-1
 OPERATION OF DPF D-9
 OPERATION OF PTO D-7
 OPERATION SEQUENCE OF DPF PROCESS D-9
 OPERATION TIPS D-23
 OPERATOR PROTECTIVE STRUCTURE (OPS) B-13
 OTHER PRECAUTIONS G-7
 OTHERS D-26
 OWNER AASISTANCE A-13

• **P**

PARK TRACTOR SAFELY B-4
 PARKING BRAKE LAMP C-9
 PARKING BRAKE LEVER C-14
 PARKING THE TRACTOR D-5
 PERIODICAL CHECK AND SERVICE SCHEDULE TABLE E-2
 POSITION LEVER C-19
 PRACTICE SAFE MAINTENANCE B-6

PRECAUTION TO AVOID RIPPING	B-4	ROPS	A-14
PRECAUTIONS FOR HANDLEING IMPLEMENTS	D-17	ROPS (ROLL OVER PROTECTIVE STRUCTURE)	A-14
PREVENT ACID BURNS	B-7	ROPS TYPE	A-15
PREVENT BATTERY EXPLOSION	B-7	RUNNING-IN PERIOD	D-2
PROPER FREE PLAY OF CLUTCH/BRAKE PEDAL	E-18		
PROTECT CHILDREN	B-3		
PTO LAMP	C-10, D-7		
PTO MODE SWITCH	C-5		
PTO ROTATION TABLE	D-8		
PTO SHAFT CAP	C-23		
PTO SHIFT LEVER	C-22		
PTO SWITCH	C-5		
• R		• S	
RADIATOR HOSE CHECKING	E-19	SAFE OPERATION OF YOUR TRACTOR	B-15
READ SAFETY INSTRUCTION	B-2	SAFETY DECALS	B-24
REAR WINDOW	C-31	SAFETY DECALS ON CHASSIS	B-25
REARVIEW MIRROR	C-31	SAFETY FRAME ROPS	C-28
RECIRCULATION INLETS FULLY CLOSED	C-34	SAFETY INSTRUCTIONS	B-2
REMOTE CONTROL LEVER	C-20	SAFETY MARK	G-2
REMOTE CONTROL VALVE	C-20	SAFETY PRECATIONS WHEN USING LOADER	B-10
REPLACING ENGINE OIL FILTER CARTRIDGE	E-11	SAFETY PRECAUTIONS	B-1
REPLACING LAMP BULB	E-17	SAFETY START	B-9
RIGHT SIDE OF THE TRACTOR (CABIN)	A-6	SAFETY TIPS DURING MAINTENANCE	B-16
RIGHT SIDE OF THE TRACTOR (FRONT ROPS)	A-4	SEAT ADJUSTMENT	A-16
RIGHT SIDE OF THE TRACTOR (REAR ROPS)	A-2	SEAT AND SAFETY BELT	C-23
		SEAT BACK RECLINING	A-17
		SEAT SLIDING	A-16
		SERVICE & PARTS	A-9
		SERVICE TRACTOR SAFELY	B-8
		SHIFTING AND DRIVING	D-4
		SHUTTLE SHIFT LEVER	C-15
		SIGNAL SIGNS	B-2
		SPECIFICATIONS	H-2

STANDARD FOR FARMWORK ·····	G-1	TOWING WITH ENGINE RUNNING ·····	D-13
START & STOP OF ENGINE ·····	D-2	TRACTOR IDENTIFICATION ·····	A-9
START ON STEEP SLOPE ·····	D-5	TRACTOR INSTRUMENTS ·····	C-1
STARTING OFF ·····	D-4	TRACTOR RUNAWAY ·····	B-9
STAY CLEAR OF ROTATING SHAFTS ·····	B-5	TRANSMISSION STRAINER CLEANING ·····	E-10
STEERING WHEEL TROUBLESHOOTING ·····	F-6	TRANSPORT TRACTOR BY TRUCK ·····	B-12
STOPPING ENGINE ·····	D-3	TRAVELING SPEED ·····	H-5
STORING THE TRACTOR ·····	E-22	TROUBLESHOOTING ·····	F-1
SUB SHIFT LEVER ·····	C-16	TURN SIGNAL LAMPS ·····	C-8
SWITCHES ·····	C-2	TURNING IN FIELD ·····	D-4
		TYPE OR NUMBER OR ENGINE & CHASSIS ·····	A-9
• T			
TACHOMETER ·····	C-7	• U	
TECHNICALLY PERMISSIBLE TOWABLE MASSES ·····	C-28	UNIVERSAL SYMBOLS ·····	B-30
THE FOLLOWING PRECAUTIONS ARE SUGGESTED TO		USAGE AND DISPOSAL ·····	E-23
HELP PREVENT ACCIDENTS ·····	B-18	USE AFTER LONG-TERM STORAGE ·····	E-23
THREE POINT LINKAGE ·····	C-24	USE OF HAZARDOUS SUBSTANCES ·····	B-13
THROTTLE LEVER ·····	C-15	USE OF ROPS AND SEAT BELT ·····	B-3
TILT LEVER ·····	C-17	USE OF TRACTOR WITH ROPS LOWERED CAN CAUSE	
TIPS FOR DRIVING ON SLOPE ·····	D-5	FATAL INJURIES ·····	A-14
TIRE INFLATION PRESSURE ·····	E-19		
TOP LINK ADJUSTMENT ·····	C-26	• V	
TOWING DEVICES ·····	C-27	VACUUM VALVE CLEANING ·····	E-12
TOWING SAFELY ·····	B-12	VENTILATION ·····	C-34
TOWING THE TRACTOR ·····	D-13	VIBRATION REFERRED TO THE OPERATOR POSITION ·····	H-8
TOWING WITH ENGINE OFF ·····	D-14		

• **W**

WARRANTY OF THE PRODUCT ····· A-9
WASHER FLUID TANK ····· C-35
WATER SEPARATOR WARNING LAMP ····· C-11
WINTER OPERATION WITH DIESEL FUEL ····· D-26
WIPER, WINDOW WASHER, WORKING LAMP CONTROL ··· C-34
WORK IN VENTILATED AREA ····· B-8
WORK PROCEDURES ····· D-17
WORKING LAMPS ····· C-31



T355 / T395 (FC, NC, ST)

OPERATOR'S MANUAL FOR TYM TRACTORS

⚠ ALL INFORMATION, ILLUSTRATIONS AND SPECIFICATIONS IN THIS MANUAL ARE BASED ON LATEST INFORMATION AVAILABLE AT THE TIME OF PUBLICATION. THE RIGHT IS RESERVED TO MAKE CHANGES AT ANY TIME WITHOUT A NOTICE.

221123

**PART NO.
1396-940-001-1**